

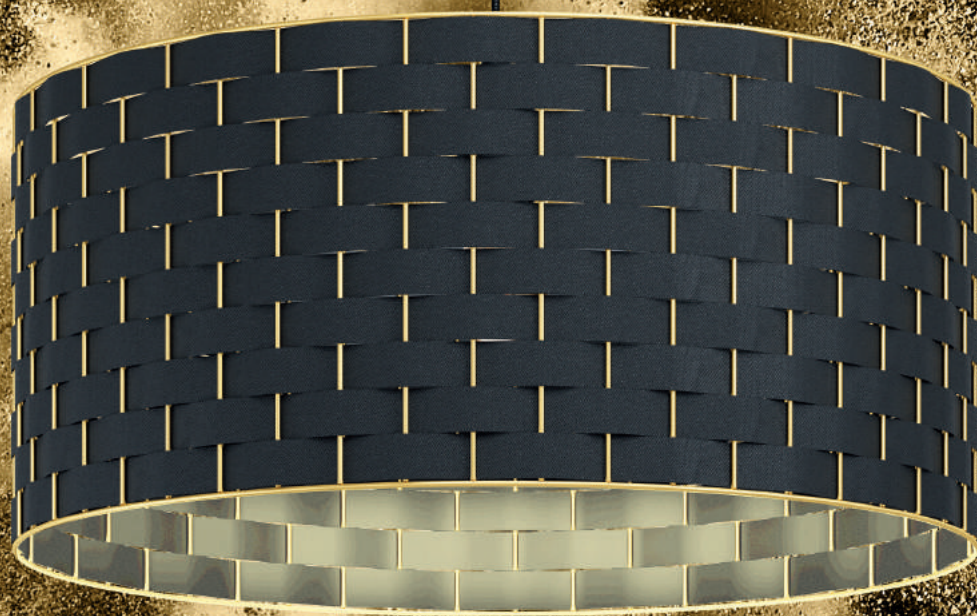

**EGLO**  
my light | my style



**2021/22**

**INTERIOR LIGHTING**

WOHNRAUMLEUCHTEN  
LUMINAIRES INTÉRIEURS









Dear customers and business partners,  
loyal EGLO friends,

For the past year, the world has held its breath. It is a year that everyone will remember as one of distance and sacrifice, but also of opportunity and transformation.

Digitalisation in particular has undergone enormous growth recently, and we have met this challenge in various ways. During the last year we introduced our new online catalogue, which offers valuable additional information and features, and provides a more in-depth view of our range of products. We want to continue providing these additional benefits in future and include our entire living room lighting range in this popular digital format. In the 2021/22 season you can look forward as ever to some real lighting highlights, featuring a natural, minimalist, elegant design that is right on-trend, with warm, earthy tones and elements of wood and brass that will fit well in any home. Because of this natural design and the increased importance we as a society are placing on our connection with nature, we wanted to engage more intensively with the theme of sustainability and recognise our responsibility toward the environment. One of the ways we have achieved this is through compliance with FSC® standards, which promote responsible global forest management.

I hope you enjoy browsing our new catalogue.



Mag. René Tiefenbacher  
CEO EGLO Group

Geschätzte Kunden und Geschäftspartner,  
treue EGLO Freunde,

das vergangene Jahr hat die Welt in Atem gehalten und wird in den Köpfen aller bleiben, als ein Jahr der Distanz und des Verzichts, aber auch als ein Jahr der Chancen und des Wandels. Gerade der Bereich der Digitalisierung hat in kurzer Zeit ein enormes Wachstum erlebt und auch wir haben uns dieser Herausforderung auf verschiedenen Arten gestellt. Im letzten Jahr haben wir Ihnen bereits erstmals unseren neuen Online-Hauptkatalog vorgestellt, der Dank seiner zusätzlichen Informationen und Features einen deutlichen Mehrwert bietet und detailliertere Einblicke in unser Sortiment verspricht. Diesen zusätzlichen Vorteil möchten wir Ihnen auch in Zukunft bieten und unser gesamtes Wohnraumleuchten-Sortiment in diesem beliebten Digitalformat anbieten. In der Saison 2021/22 erwarten Sie wie gewohnt wahre Trend- und Leuchten-Highlights, die aktuell von Natürlichkeit, Minimalismus, aber auch von Eleganz geprägt sind und mit ihren warmen Erdtönen, sowie Holz- und Messing-Elementen einen Platz in jedem Zuhause finden. Gerade in Bezug auf die Natürlichkeit und die für uns Menschen deutlich an Bedeutung gewonnene Verbundenheit zur Natur hat uns dazu veranlasst, uns noch stärker mit dem Thema Nachhaltigkeit auseinanderzusetzen und unserer Verantwortung gegenüber der Umwelt Rechnung zu tragen. Dies ist uns unter anderem mit der Einhaltung der FSC® Standards gelungen, die eine verantwortungsvolle weltweite Waldbewirtschaftung fördern.

Ich wünsche Ihnen viel Freude beim  
Durchschauen des neuen Hauptkatalogs.

Très chers clients et partenaires,  
fidèles amis d'EGLO,

L'année 2020 a tenu le monde en haleine et restera gravée dans tous les esprits comme une année de distanciation et de sacrifices, mais aussi comme une année d'opportunités et de changement. Le secteur du numérique, par exemple, a connu une croissance fulgurante en peu de temps, et nous avons relevé les défis qui en découlent de diverses manières. L'an dernier, nous vous avons présenté la première version électronique de notre nouveau catalogue. Grâce aux informations et fonctionnalités supplémentaires qu'il contient, il offre une plus grande valeur ajoutée ainsi qu'un aperçu plus détaillé de notre gamme de produits. À l'avenir, nous souhaitons continuer à vous offrir cet avantage et proposer toute notre gamme d'éclairage pour la maison au format numérique. Pour la saison 2021/22, vous pouvez vous attendre, comme d'habitude, à des nouveautés en matière de tendances et d'éclairage. Les mots d'ordre sont nature, minimalisme, mais aussi élégance. Avec leurs éléments en bois et en laiton, ainsi que leurs tons chauds, nos produits trouveront leur place dans chaque intérieur. Le caractère naturel et le lien avec la nature, qui a clairement gagné en importance pour nous tous, nous ont incités à nous pencher encore plus sur le thème de la durabilité et à assumer notre responsabilité envers l'environnement. L'un des moyens d'y parvenir est de se conformer aux normes FSC®, qui promeuvent une gestion responsable des forêts à travers le monde.

Je vous souhaite beaucoup de plaisir à parcourir le  
nouveau catalogue.



# CONTENTS

INHALT  
CONTENU



## EGLO CONNECT

**P.010 - 077**



**LIGHTING FAMILIES**  
FABRIC & WOOD LUMINAIRES  
STOFF- UND HOLZLEUCHTEN  
LUMINAIRES À TEXTIL ET BOIS

**P.100 - 191**



## EGLO ACCESS

**P.078 - 099**



**LIGHTING FAMILIES**  
STANDARD LUMINAIRES  
STANDARD LEUCHTEN  
LUMINAIRES STANDARD

**P.192 - 301**



**LIGHTING FAMILIES**  
GLASS CHANDELIERS  
LEUCHTENFAMILIEN  
FAMILLES DE LUMINAIRES

**P.302 - 311**



## HANGING & PENDANT LUMINAIRES

HÄNGE- & PENDELLEUCHTEN  
LUMINAIRES SUSPENSIONS

**P.312 - 409**





## WALL & CEILING LUMINAIRES

WAND- & DECKENLEUCHTEN  
APPLIQUES & PLAFONNIERS

**P.410 - 553**



## TABLE & FLOOR LUMINAIRES

TISCH- & STEHLEUCHTEN  
LUMINAIRES DE TABLE & LAMPADAIRES

**P.712 - 749**



## BATH & MIRROR LUMINAIRES

BAD- & SPIEGELLEUCHTEN  
LUMINAIRES DE BAIN & MIROIR

**P.554 - 615**



## OFFICE TABLE LUMINAIRES

OFFICE TISCHLEUCHTEN  
LAMPES DE TABLE DE BUREAU

**P.750 - 779**



## SPOTS & TRACK LUMINAIRES

SPOTS- & SCHIENENLEUCHTEN  
SPOTS & LUMINAIRES SUR RAIL

**P.616 - 703**



## CHILDREN LUMINAIRES

KINDERLEUCHTEN  
LUMINAIRES POUR ENFANTS

**P.780 - 785**



## CLIP & PLUG LUMINAIRES

KLEMM- & STECKERLEUCHTEN  
LUMINAIRES À PINCE & SUR PRISE

**P.704 - 711**



## KITCHEN & FUNCTION LUMINAIRES

KÜCHEN- & FUNKTIONSLEUCHTEN  
LUMINAIRES FONCTIONNELS & DE CUISINE

**P.786 - 791**



## ACCESSORIES

ZUBEHÖR  
ACCESSOIRES

**P.792 - 795**



## INDEX & LEGEND

INDEX & ERKLÄRUNG  
INDEX & LÉGENDE

**P.796 - 824**





# EGLO TREND HIGHLIGHTS

## 2021/22

The EGLO design team has once again drawn on current mega-trends as a source of inspiration for the 2021/22 season. The new EGLO products' use of shape and colour, choice of materials, and overall aesthetic harmonise perfectly with both contemporary and future living trends. Minimalism and the increasingly popular use of materials and colours such as brass and earth tones have had a particularly strong influence on this season's luminaire designs.

Auf Basis der Megatrends hat sich das Design-Team von EGLO auch für die Saison 2021/22 inspirieren lassen. Mit ihrer Formsprache, Farbgebung sowie den verwendeten Materialien fügen sich die EGLO Neuheiten in die aktuellen wie auch zukünftigen Wohntrends ein. Der Trend des Minimalismus sowie die Verwendung von Materialien und Farben wie Messing und Erdtöne haben auf die aktuellen Leuchten-Designs besonderen Einfluss genommen.

Sur la base des mégatendances, l'équipe de conception EGLO a également été inspirée pour la saison 2021/22. Avec leur langage visuel, leur palette de couleurs et les matériaux utilisés, les innovations EGLO s'intègrent dans les tendances de la vie d'aujourd'hui et de demain. La tendance au minimalisme et l'utilisation de matériaux et de couleurs tels que le laiton et les tons de terre ont eu une influence particulière sur les conceptions actuelles de nos luminaires.

**MINIMALISM** - The art of less, the conscious reduction of shapes and colours to the bare essentials, is reflected in our luminaires. Clear and simple shapes and plain colours combine to create a calm atmosphere, in keeping with the maxim "less is more". Warm grey tones and timber elements give the room a welcoming touch, adding atmospheric highlights and offering a harmonious stage for your entire living space to work its magic without any distractions.

**MINIMALISMUS** - Der bewusste Verzicht und die Kunst, Form und Farbe auf ein Minimum zu reduzieren, spiegelt sich in unseren Leuchten wider. Frei nach dem Prinzip „Weniger ist mehr“ sorgen klare und einfache Formen sowie schlichte Farben für eine ruhige Atmosphäre. Für die nötige Gemütlichkeit setzen warme Grautöne oder Holzelemente stimmungsvolle Akzente und bieten eine harmonische Bühne, um den gesamten Raum ganz ohne Ablenkung für sich wirken zu lassen.

**LE MINIMALISME** - Nos lampes reflètent un renoncement volontaire et l'art de réduire au minimum formes et couleurs. Selon le principe « faire plus avec moins », des formes claires et simples et des couleurs unies créent une atmosphère paisible. Pour le confort, des tons gris chauds ou des éléments en bois mettent en place une ambiance agréable et un décor harmonieux pour vous permettre de travailler dans une pièce sans aucune distraction.





ABREOSA



## LAGUNITAS

**Brass** - Brass so popular back in the 50s and 60s, is currently enjoying a new wave of popularity. Skilfully paired with contrasting materials, the gleaming metallic hues of brass bring a touch of luxury to living spaces without appearing old-fashioned. We have incorporated the high-quality material into our new luminaire models and combined it with diverse other materials to create captivating modern designs that can be integrated into a variety of interiors, from urban to classical to minimalist.

**Messing** - Der bereits in den 50er und 60er Jahren so populäre Messingtrend erfreut sich aktuell an neuer Beliebtheit. Gekonnt kombiniert und kontrastreich in Szene gesetzt, bringt Messing mit seinem strahlenden Metallton einen Hauch von Luxus in die Wohnräume, ohne altmodisch zu wirken. Das hochwertige Material haben wir in unsere neuen Leuchten-Modelle einfließen lassen und in Kombination mit verschiedenen Materialien charmante und moderne Designs geschaffen, die sich in unterschiedliche Einrichtungen von urban über klassisch bis hin zu minimalistisch integrieren lassen.

**Le laitton** - La tendance du laitton, déjà si populaire dans les années 50 et 60, est actuellement à nouveau au goût du jour. Habilement combiné et mis en scène avec de riches contrastes, le laitton avec sa teinte métallique brillante apporte une touche de luxe aux espaces de vie sans paraître démodé. Nous avons incorporé ce matériau de haute qualité dans nos nouveaux modèles de luminaires et, en combinaison avec divers matériaux, avons créé des designs charmants et modernes qui peuvent être intégrés à des aménagements différents, qu'ils soient notamment urbains, classiques ou encore minimalistes.

**Warm earth tones** - The very popular back-to-nature trend has also brought about a significant shift in the field of design. More and more people have been embracing a return to nature in recent years and the associated use of natural materials has also left its mark on the world of colour, heralding the rise of brown as the new black. The colour brown in all its many facets can be beautifully paired with almost any other colour and, thanks to its diverse earthy tones, not only lends our living spaces a touch of naturalness, but also conveys a sense of warmth and comfort. Combining this year's popular colour trend with wood and brass elements helps accentuate its distinctive appeal.

**Warme Erdtöne** - Der starke Trend hin zu mehr Natürlichkeit hat auch im Design einen bedeutsamen Wandel bewirkt. Die in den letzten Jahren deutlich an Bedeutung gewonnene Verbundenheit zur Natur und die damit einhergehende Verwendung von natürlichen Materialien hat auch die Farbwelt geprägt und lässt Braun als das neue Schwarz triumphieren. Braun in all seinen Facetten lässt sich hervorragend kombinieren und verleiht unseren Wohnräumen durch seine vielfältigen Erdtöne nicht nur einen Hauch von Natürlichkeit, sondern vermittelt Gemütlichkeit und Behaglichkeit gleichermaßen. Die Kombination mit Holz oder Messing verleiht der neuen Trendfarbe ihre besonderen Akzente.

**Des tons chauds de terre** - La forte tendance vers un caractère plus naturel a également entraîné un changement significatif dans notre conception. Le lien avec la nature, qui a grandement gagné en importance ces dernières années, et l'utilisation associée de matériaux naturels ont également façonné l'univers des couleurs : c'est ainsi que le brun a détrôné le noir. Le brun sous toutes ses facettes peut être parfaitement combiné et, avec ses divers tons de terre, non seulement donner à nos salons une touche naturelle, mais aussi procurer confort et bien-être dans le même temps. La combinaison de cette nouvelle couleur tendance avec le bois ou le laiton lui confère ses accents si particuliers.



## LOSALOMAS



# Look out for this Logo!

Achten Sie auf das Logo!

Soyez attentif au logo !

## What is a forest?

A peaceful oasis, the green lungs of the world, and an adventure playground for children of all ages!

The Forest Stewardship Council® (FSC®) is a global, not-for-profit organisation dedicated to the promotion of responsible forest management worldwide. The FSC® defines standards for responsible forest management in accordance with established principles that are developed and supported by stakeholders from the environmental, social and economic spheres. For more information, please see [www.fsc.org](http://www.fsc.org).

## Was ist Wald für uns?

Eine Oase der Ruhe, die Lunge der Welt oder ein Abenteuerspielplatz für große und kleine Kinder!

Das Forest Stewardship Council® (FSC®) ist eine globale, gemeinnützige Organisation, mit dem Zweck verantwortungsvolle Waldbewirtschaftung weltweit zu fördern. FSC® definiert Standards für eine verantwortungsvolle Waldbewirtschaftung nach festgelegten Prinzipien, die von Interessenvertretern aus den Bereichen Umwelt, Soziales und Wirtschaft entwickelt und getragen werden. Für weitere Informationen besuchen Sie [www.fsc.org](http://www.fsc.org).

## Que représente la forêt pour nous ?

Une oasis de calme, les poumons du monde ou un terrain de jeu d'aventure pour les enfants de tous âges !

Le Forest Stewardship Council® (FSC®) est une organisation internationale à but non lucratif dont le but est de promouvoir une gestion forestière responsable dans le monde entier. Le FSC® définit des normes de gestion forestière responsable selon des principes établis qui sont développés et soutenus par les parties prenantes des secteurs environnemental, social et économique. Pour plus d'informations, veuillez consulter [www.fsc.org](http://www.fsc.org).

Look out for FSC® -certified products!  
Achten Sie auf FSC® -zertifizierte Produkte!  
Soyez attentif aux produits certifiés FSC® !



The mark of  
responsible forestry

# DIGITAL CATALOGUE

This year, we are also making the main catalogue in front of you available online, including lots of extra information and additional features. In addition to search and filter functions, the online catalogue includes extensive product photos, videos and additional information, complementing the paper edition wonderfully. Take a look at

<https://catalogue.eglo.com>

In diesem Jahr präsentieren wir den vor Ihnen liegenden Hauptkatalog wieder als Online-Katalog mit vielen Zusatzinformationen und zusätzlichen Features. Neben Such- und Filterfunktionen bietet der Online-Katalog mit reichhaltigen Produktabbildungen, Videos und zusätzlichen Informationen einen erheblichen Mehrwert zur gebundenen Ausgabe. Klicken Sie sich rein unter <https://catalogue.eglo.com>

Cette année, nous présentons à nouveau une version en ligne du catalogue général. Cette version contient de nombreuses informations et fonctionnalités complémentaires. Outre les fonctionnalités de recherche et de filtrage, le catalogue en ligne propose de nombreuses illustrations de produits, des vidéos et des informations complémentaires : une valeur ajoutée considérable par rapport à la version papier. Cliquez ici pour le découvrir : <https://catalogue.eglo.com>



99795



NEW/ NEU/ NOUVEAU





# connect.2

 **zigbee**  **Bluetooth®**



# Discover the smart world



# OVERVIEW

EGLO CONNECT Z

 CONNECT-Z SENSOR p. 21	 CONNECT Z p. 21	 REMOTE 2.0 p. 21	 VALDELAGRANO-Z p. 22	 SIMOLARIS-Z p. 22-23	 MARGHERA-Z p. 24-25	 CAMINALES-Z p. 26	 SALICETO-Z p. 27
 LOMALTAS-Z p. 28	 TABIANO-Z p. 29	 JUAREZA-Z p. 29	 FRAIOLI-Z p. 30-31	 TOTARI-Z p. 32-33	 LANCIANO-Z p. 34	 CAPASSO-Z p. 35	 SILERAS-Z p. 35
 SAVATARILA-Z p. 36-37	 TURCONA-Z p. 38,42-43	 HERRORA-Z p. 40	 SALOBRENA-Z p. 44-47	 FUEVA-Z p. 48-59	 ROVITO-Z p. 60-63	 LED STRIPE-Z p. 64-65	 LM_LED_E27 p. 66
 LM_LED_E27 p. 66	 LM_LED_E14 p. 66	 LM_LED_GU10 p. 67	 LM_LED_E27 p. 68	 LM_LED_E27 p. 68	 LM_LED_E27 p. 68	 LM_LED_E27 p. 69	 LM_LED_E27 p. 69
 LM_LED_E27 p. 69	 LM_LED_E27 p. 70	 LM_LED_E27 p. 70	 LM_LED_E27 p. 70	 LM_LED_E27 p. 71	 LM_LED_E27 p. 71	 LM_LED_E27 p. 71	 LM_LED_E27 p. 72
 LM_LED_E27 p. 72	 LM_LED_E27 p. 72	 LM_LED_E27 p. 73	 LM_LED_E27 p. 73	 LM_LED_E27 p. 74	 LM_LED_E27 p. 74	 LM_LED_E27 p. 74	 LM_LED_E27 p. 75
 LM_LED_E27 p. 75	 LM_LED_E27 p. 76	 LM_LED_E27 p. 76	 LM_LED_E27 p. 76	 LM_LED_E27 p. 77			



This product is available in different colors and shapes./ Dieser Artikel ist in unterschiedlichen Farben und Formen verfügbar.  
Cet article est disponible en différentes couleurs et formes.







## connect.z combines two control technologies in one system

connect.z vereint zwei Steuerungstechnologien in einem System

connect.z réunit deux technologies de commande au sein d'un même système



ZigBee is far and away the most widely used standard in the smart home world.

ZigBee ist der am weitesten verbreitete Standard in der Smart Home Welt.

ZigBee est le protocole le plus répandu au monde dans le domaine du Smart Home.

### ADVANTAGES :

- › Mesh network
- › Direct connection with Amazon Echo and Google Home
- › Compatible with products from different manufacturers
- › High level of security
- › Easy setup
- › Energy efficient

### VORTEILE:

- › Mesh-Netzwerk
- › Direkte Verbindung mit Amazon Echo und Google Home
- › Herstellerübergreifend kompatibel
- › Hohe Sicherheit
- › Einfache Einrichtung
- › Energieeffizient

### AVANTAGES:

- › Réseau maillé
- › Connexion directe à Amazon Echo et Google Home
- › Compatible indépendamment du fabricant
- › Sécurité élevée
- › Installation facile
- › Économe en énergie

# connect.2



Bluetooth is an established standard in the digital world.  
Bluetooth ist ein etablierter Standard in der digitalen Welt.  
Bluetooth est un standard de communication reconnu dans le monde numérique.

#### ADVANTAGES:

- › Local & secure network
- › Protocol is mainly audio (low debit)
- › Mesh network: Elements are receivers and senders
- › Easy setup
- › Usable offline
- › Energy efficient

#### VORTEILE:

- › Lokales & sicheres Netzwerk Protokoll hauptsächlich Audio (Low Debit)
- › Mesh-Netzwerk: Elemente sind Empfänger und Sender
- › Einfache Einrichtung
- › Offline nutzbar
- › Energieeffizient

#### AVANTAGES:

- › Réseau local et sûr
- › Protocole essentiellement audio (bas débit)
- › Réseau maillé : les éléments sont l'émetteur et le récepteur
- › Installation facile
- › Utilisable hors-ligne
- › Économe en énergie

# Light up your world!

Bringen Sie Licht in Ihren Alltag!  
Illuminez votre quotidien !



connect.z offers a wide range of lamps and lighting equipment. Select products from the following options according to your needs:  
connect.z bietet ein großes Sortiment an Leuchten und Leuchtmitteln. Wählen Sie die Produkte ganz nach Ihren Bedürfnissen aus folgenden Varianten:  
connect.z propose une large gamme de luminaires et d'ampoules. Sélectionnez les produits en fonction de vos besoins parmi les variantes suivantes :

**Warm White**

**Neutral White**

**Tunable White**

Individual light from 50,000 white tones.  
Individuelles Licht aus 50.000 Weißtönen.  
Luminaire individuel à 50 000 tons de blanc.

**TW + RGB Colors**

Diverse lighting selection from 50,000 white tones and 16 million colours.  
Vielseitige Lichtauswahl aus 50.000 Weißtönen und 16 Mio. Farben.  
Sélection étendue de luminaires à 50 000 tons de blanc et 16 millions de couleurs.

Enjoy relaxing moments!  
Genießen Sie entspannte Momente!  
Profitez de moments de détente !

Stay focussed & efficient!  
Bleiben Sie konzentriert & leistungsfähig!  
Restez concentré(e) et performant(e) !

Start the day fresh every morning!  
Starten Sie jeden Morgen frisch in den Tag!  
Commencez la journée du bon pied !

Create the perfect atmosphere!  
Kreieren Sie Ihr perfektes Ambiente!  
Créez votre ambiance parfaite !





## Enjoy many useful convenience features:

Es erwarten Sie viele nützliche Komfortfunktionen:

De nombreuses fonctionnalités utiles vous attendent pour votre confort :



### TIMERS AND CALENDARS / TIMER UND ZEITPLÄNE/ MINUTERIE ET CALENDRIER

Make your daily life easier with timers and calendars.  
Wake up relaxed with the simulated sunrise.

Unterstützen Sie Ihren Alltag mit Timern und Zeitplänen. Entwickeln Sie eigene Lichtroutinen und machen Sie Ihr Leben leichter.

Facilitez-vous la vie à l'aide de la fonction minuterie et calendrier.  
Réveillez-vous en douceur grâce au simulateur de lever de soleil



### LIGHT ALARM CLOCK/ LICHTWECKER/ REVEIL LUMINEUX

You'd rather not start your day in a bad mood? Wake up relaxed with the simulated sunrise.

Keine Lust mit schlechter Laune in den Tag zu starten? Entspannt aufwachen mit dem simulierten Sonnenaufgang.

Pas envie de commencer la journée de mauvaise humeur ? Réveillez-vous en douceur grâce au simulateur de lever de soleil.



### DISCO FUNCTION/MODE/ DISCOFUNKTION/MODUS/ FONCTION/MODE DISCO

For the perfect party mood, the disco function synchronises the light to the beat of your favourite songs.

Für die perfekte Partystimmung schaltet die Discofunktion das Licht passend zum Beat Ihres Lieblingsongs.

Pour une ambiance festive parfaite, la fonction disco enclenche le luminaire au rythme de votre chanson préférée.



### PRESENCE SIMULATOR/ ANWESENHEITSSIMULATION/ SIMULATEUR DE PRESENCE

Protect your home with the convenient presence simulator. Variable time intervals allow the system to turn the lights on and off to simulate your presence at home and deter unwanted guests.

Schütze Sie Ihr Zuhause mit der komfortablen Anwesenheitssimulation. Dank variabler Zeitintervalle simuliert das System durch Ein- und Ausschalten der Beleuchtung die Anwesenheit im Haus und schreckt so ungebetene Gäste ab.

Protégez votre domicile à l'aide du très pratique simulateur de présence. Le système simule votre présence en allumant et en éteignant les lumières à intervalles variables et décourage ainsi les invités indésirables.

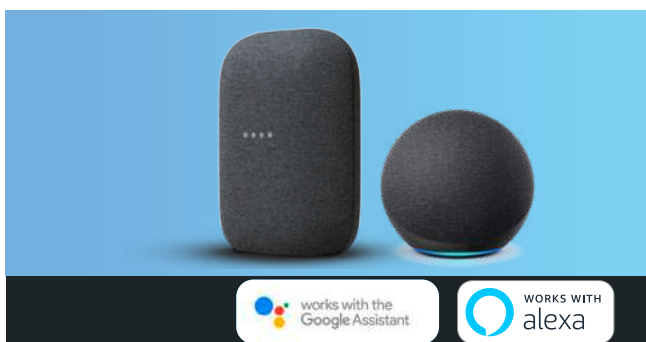

### VOICE COMMANDS/ SPRACHSTEUERUNG/COMMANDE VOCALE

More convenient! Turn the light on whenever you want with only a voice command.

Noch komfortabler! Mit nur einem Sprachbefehl schaltet sich das Licht nach Ihren Wünschen an und aus.

C'est encore plus confortable ! Allumez votre luminaire comme vous le souhaitez d'une simple commande vocale.

## Control options

Steuerungsmöglichkeiten  
Possibilités de commande



Set your smart home as you prefer! With the app, voice commands, or remote control.

Steuern Sie Ihr Smart Home wie Sie es möchten! Via App, Sprachsteuerung oder mit der Fernbedienung.

Commandez votre Smart Home comme vous le souhaitez ! Via l'appli, la commande vocale ou la télécommande.



### APP CONTROL

Use the free app for smartphone, tablet, or smartwatch.

Nutzen Sie die kostenlose App für das Smartphone, Tablet oder die Smartwatch.

Utilisez l'appli gratuite sur votre smartphone, votre tablette ou votre montre connectée.



### VOICE COMMANDS

Use intelligent voice assistants such as Google Home and Amazon Alexa.

Nutzen Sie intelligente Sprachassistenten wie Google Home und Amazon Alexa.

Utilisez des assistants vocaux intelligents comme Google Home ou Amazon Alexa.



### REMOTE CONTROL

Use the practical remote connect.z operation at any time.

Nutzen Sie auch jederzeit die praktische connect.z Fernbedienung.

Vous pouvez aussi utiliser à tout moment la télécommande connect.z.



### CONNECT.Z ACCESSORIES

Use clever accessories such as the movement sensor and much more.

Nutzen Sie cleveres Zubehör wie z.B. den Bewegungssensor uvm.

Utilisez des accessoires malins tels que le capteur de mouvement et bien d'autres encore.



### DIMMER FUNCTION

Use the practical dimmer function via app, speech command or remote control.

Nutzen Sie die praktische Dimmfunktion via App, Sprachbefehl oder Fernbedienung.

Utilisez la fonction de gradation via l'appli, la commande vocale ou la télécommande.

# One system, many possibilities!

Ein System – viele Möglichkeiten!  
Un système, de nombreuses possibilités!

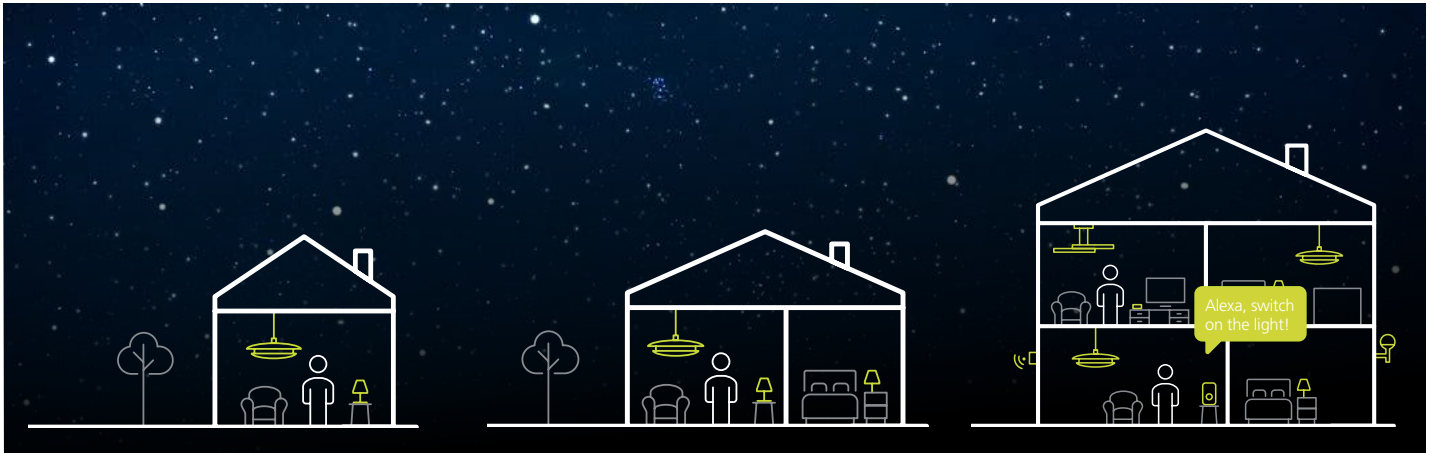

No matter how you start, you can integrate new products into your connect.z system at any time and gradually expand your smart home.  
Egal wie Sie starten, Sie können jederzeit neue Produkte in Ihr connect.z System integrieren und Ihr smartes Zuhause nach und nach erweitern.  
Quel que soit votre choix, vous pouvez à tout moment intégrer de nouveaux produits à votre système connect.z et améliorer progressivement votre maison intelligente.



**BASIC USER**

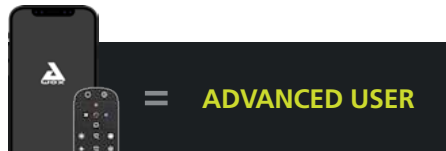

**ADVANCED USER**



**POWER USER**

All you need to start is a connect.z product and the remote control. No internet connection is required and you have access to:

Sie benötigen zum Start lediglich ein connect.z Produkt und die Fernbedienung. Es wird kein Internetzugang benötigt und Sie haben Zugriff auf:

Pour démarrer, il vous suffit d'un produit connect.z et de la télécommande. Aucune connexion Internet n'est nécessaire. Vous avez accès aux :

## Standard functions: Standardfunktionen: Fonctionnalités standard :

- › Select colour/ Farbauswahl/ sélection de couleur
- › Change colour/ Farbwechsel/ changement decouleur
- › Dim/ Dimmen/ gradation
- › Favourites (2x)/ Favoriten (2x)/ favoris (2x)
- › Groups (3x)/ Gruppen (3x)/ groupes (3x)
- › Candle mode/ Kerzenmodus/ mode bougie

Besides the standard functions, would you also like access to the practical convenience features? Then you need only your smartphone or tablet and the Awox app. This app allows you to control your lights via WIFI and Bluetooth®.

Sie möchten zu den Standardfunktionen auch noch Zugriff auf die praktischen Komfortfunktionen haben? Dann benötigen Sie nur Ihr Smartphone oder Tablet und die Awox App. Mit der App haben Sie die Möglichkeit, Ihre Leuchten über WLAN und Bluetooth® zu steuern.

Outre les options standard, vous souhaitez également pouvoir utiliser les fonctionnalités de confort les plus pratiques ? Pour cela, vous avez seulement besoin de votre smartphone ou de votre tablette et de l'appli Awox. L'appli vous permet de commander vos luminaires via le réseau Wi-Fi ou Bluetooth®.

## Standard functions + convenience features/ Standardfunktionen + Komfortfunktionen / Fonctionnalités standard + confort

- › Light alarm clock/ Lichtwecker/ réveil lumineux
- › Presence simulation/ Anwesenheitssimulation/ simulateur de présence
- › Disco function/ Discofunktion/ fonction disco
- › Timers & timetables /Timer & Zeitpläne/ minuteur et calendrier
- › Accessories can be incorporated/ Einbindung von Zubehör möglich/ connexion d'accessoires possible

Use the system's full potential and control your smart home through the Awox app using WIFI or Bluetooth® as well as integrating a voice assistant into the system. This gives you:

Nutzen Sie das volle Potenzial des Systems und steuern Sie Ihr Smart Home über die Awox App mithilfe von WLAN oder Bluetooth® und integrieren Sie zusätzlich noch einen Sprachassistenten in das System. So mit erhalten Sie:

Exploitez tout le potentiel du système en commandant votre Smart Home grâce à l'appli Awox via le réseau Wi-Fi ou Bluetooth®, et intégrez également un assistant vocal au système. Vous obtenez ainsi :

## Standard functions + convenience features + voice commands\*

## Standardfunktionen + Komfortfunktionen + Sprachsteuerung\*

## Fonctionnalités standard + confort + commande vocale\*

- › Amazon Alexa or Google Home/ Amazon Alexa oder Google Home/ Amazon Alexa ou Google Home

- \* Use a voice assistant with integrated bridge.
- \* Nutzen Sie einen Sprachassistenten mit integrierter Bridge.
- \* Utilisez un assistant vocal avec Bridge intégré.



## YOU ALREADY HAVE CONNECT-C LUMINAIRES FROM THE PREVIOUS SYSTEM! WHAT NOW?

Sie besitzen bereits connect-c Leuchten des Vorgängersystems! Was nun?  
Vous disposez déjà de luminaires connect-c de l'ancien système! Que faire ?

No problem! The previous connect-c products are compatible with the new connect.z system.  
Kein Problem! Die bisherigen connect-c Produkte sind mit dem neuen connect.z System kompatibel.  
Aucun problème! Les anciens produits connect-c sont compatibles avec le nouveau système connect.z.

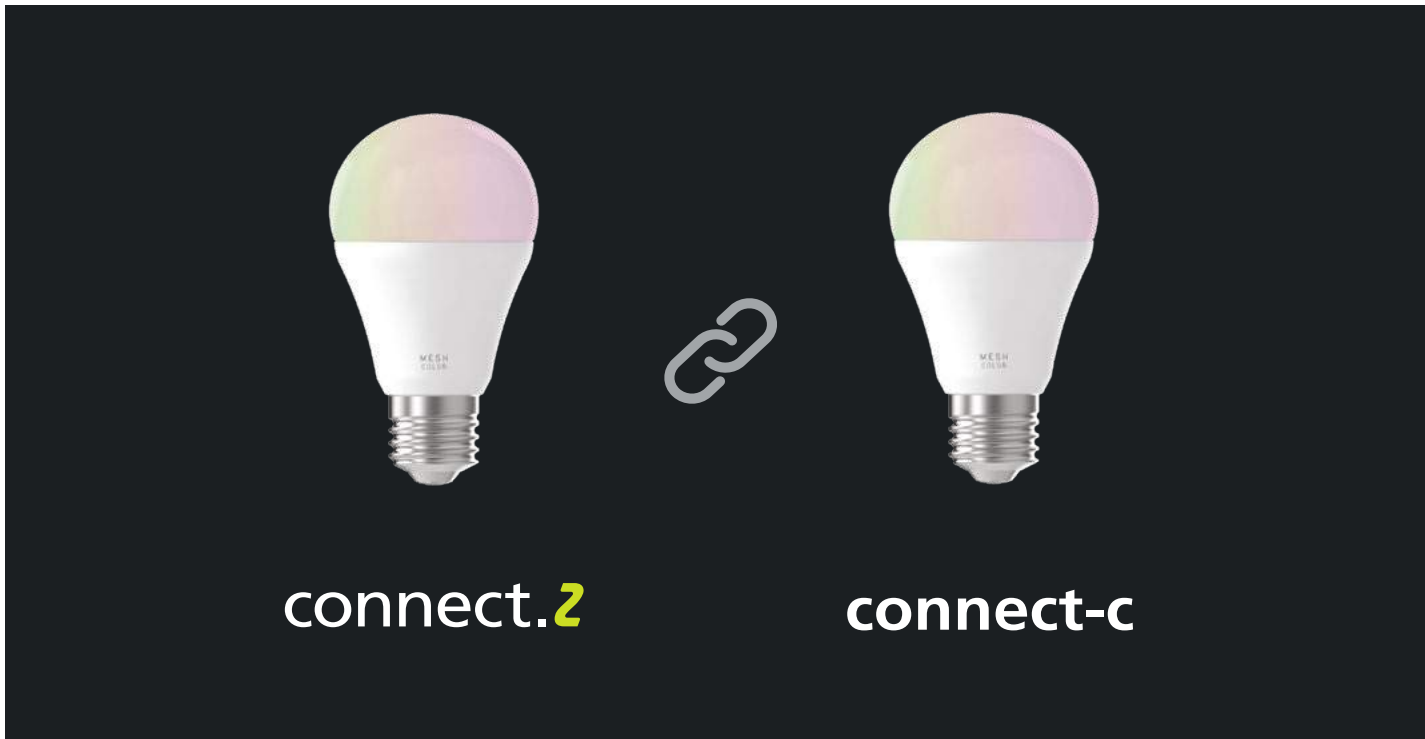

connect.z

connect-c

### EGLO connect-c - connect.z

The existing EGLO connect-c system is compatible with the new EGLO connect.z system. You don't need to switch from the existing Bluetooth low energy system to the new open protocol ZigBee 3.0. Lights from EGLO connect-c can be incorporated into the existing EGLO connect.z system.

### EGLO connect-c - connect.z

Das bestehende EGLO connect-c System ist mit dem neuen EGLO connect.z System kompatibel. Sie müssen nicht von dem bestehendem Bluetooth low energy System auf das neue offene Protokoll ZigBee 3.0 umsteigen. Leuchten von EGLO connect-c können in das bestehende EGLO connect.z System eingebunden werden.

### EGLO connect-c - connect.z

Le système EGLO connect-c existant est compatible avec le nouveau système EGLO connect.z. Vous n'avez pas besoin de passer du système Bluetooth à basse consommation existant au nouveau protocole ouvert ZigBee 3.0. Les luminaires EGLO connect-c peuvent être intégrés au système EGLO connect.z existant.



99106



120°, 12 m  
20 sec. - 10 min.



99099



33994

### 99106 CONNECT-Z SENSOR

accessory; plastic, white  
Zubehör; Kunststoff, weiss  
accessoire; plastique, blanc

L 75, H 75, A 70

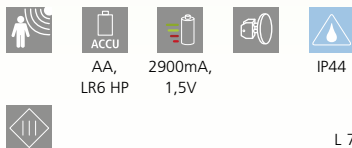

9 002759 991067



### 33994 CONNECT Z

remote control; plastic, white  
Fernbedienung; Kunststoff, weiss  
Télécommande; plastique, blanc

L 56, B 24, H 112

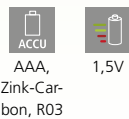

9 002759 339944



### 99099 REMOTE 2.0

remote control; plastic, grey  
Fernbedienung; Kunststoff, grau  
Télécommande; plastique, gris

L 122, B 54, H 18

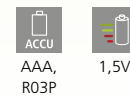

9 002759 990992







### 900075 VALDELAGRANO-Z

pendant light; steel, wood, black / fabric, white  
 Hängeleuchte; Stahl, Holz, schwarz / Textil, weiss  
 luminaire en suspension; acier, bois, noir / tissu, blanc

L 1000, B 105, H 1100

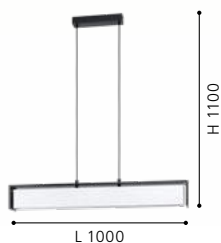
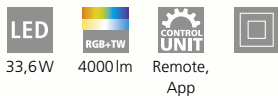

### 99603 SIMOLARIS-Z

pendant light; aluminium, steel, black / plastic, white  
 Hängeleuchte; Alu, Stahl, schwarz / Kunststoff, weiss  
 luminaire en suspension; aluminium, acier, noir / plastique, blanc

L 1220, B 55, H 1100

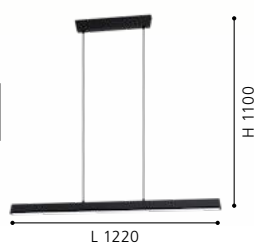

### 99601 SIMOLARIS-Z

ceiling light; aluminium, steel, black / plastic, white  
 Deckenleuchte; Alu, Stahl, schwarz / Kunststoff, weiss  
 plafonnier; aluminium, acier, noir / plastique, blanc

L 470, B 55, H 110





99602



99604

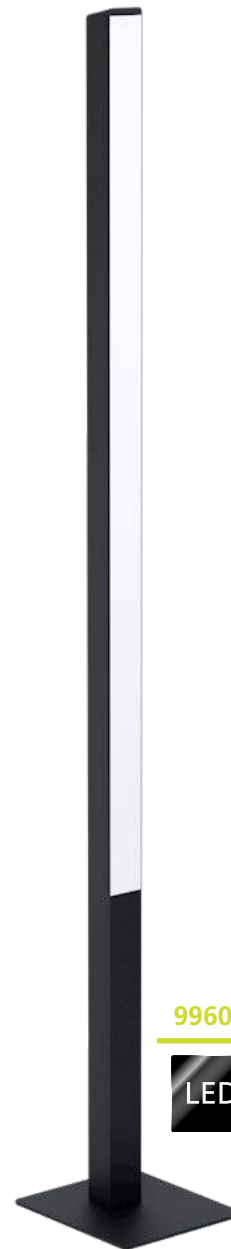

99605



### 99602 SIMOLARIS-Z

ceiling light; aluminium, steel, black / plastic, white  
Deckenleuchte; Alu, Stahl, schwarz / Kunststoff, weiss  
plafonnier; aluminium, acier, noir / plastique, blanc

L 1220, B 55, H 110

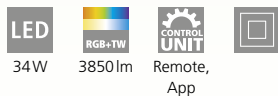

### 99604 SIMOLARIS-Z

table light; aluminium, steel, black / plastic, white  
Tischleuchte; Alu, Stahl, schwarz / Kunststoff, weiss  
luminaire de table; aluminium, acier, noir / plastique, blanc

L 55, B 55, H 515, Base: B 160, T 120



### 99605 SIMOLARIS-Z

floor light; aluminium, steel, black / plastic, white  
Stehleuchte; Alu, Stahl, schwarz / Kunststoff, weiss  
lampadaire; aluminium, acier, noir / plastique, blanc

L 55, B 55, H 1615, Base: B 240, T 210

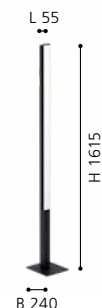



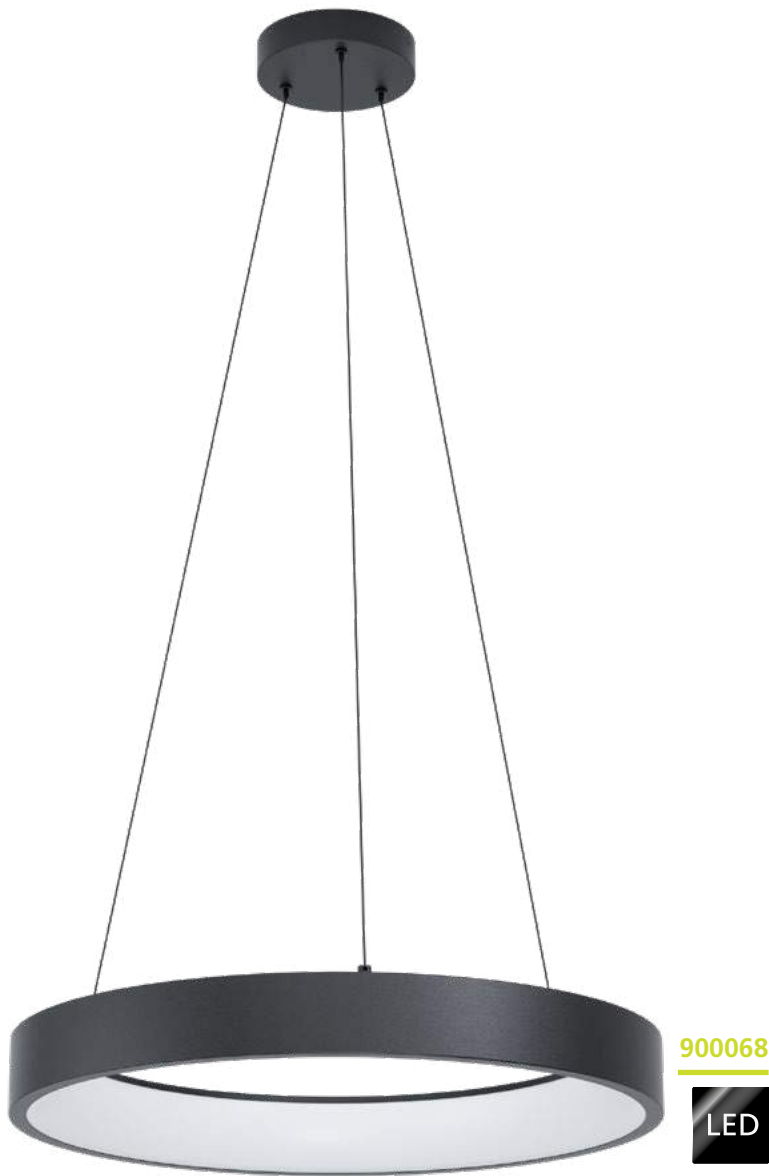

### 900068 MARGHERA-Z

pendant light; steel, black / plastic, white  
 Hängeleuchte; Stahl, schwarz / Kunststoff, weiss  
 luminaire en suspension; acier, noir / plastique, blanc

H 1100, Ø 600

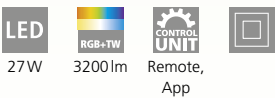

27W 3200lm Remote, App



### 900067 MARGHERA-Z

ceiling light; steel, black / plastic, white  
 Deckenleuchte; Stahl, schwarz / Kunststoff, weiss  
 plafonnier; acier, noir / plastique, blanc

H 110, Ø 600

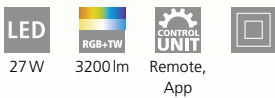

27W 3200lm Remote, App

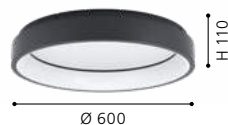

### 900069 MARGHERA-Z

wall light; steel, black / plastic, white  
 Wandleuchte; Stahl, schwarz / Kunststoff, weiss  
 applique; acier, noir / plastique, blanc

L 270, H 305, A 200



16W 1900lm Remote, App





900071



900072



**900071 MARGHERA-Z**

table light; steel, black / plastic, white  
Tischleuchte; Stahl, schwarz / Kunststoff, weiss  
luminaire de table; acier, noir / plastique, blanc

L 270, H 265, Base: Ø 145



**900072 MARGHERA-Z**

floor light; steel, black / plastic, white  
Stehleuchte; Stahl, schwarz / Kunststoff, weiss  
lampadaire; acier, noir / plastique, blanc

L 270, B 305, H 1690, Base: Ø 305

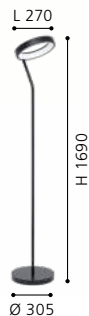
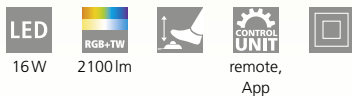





99673

LED



99674

LED



99675

LED



### 99673 CAMINALES-Z

ceiling light; steel, black  
Deckenleuchte; Stahl, schwarz  
plafonnier; acier, noir

L 125, B 125, H 120

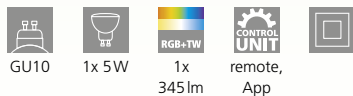

### 99674 CAMINALES-Z

ceiling light; steel, black  
Deckenleuchte; Stahl, schwarz  
plafonnier; acier, noir

L 240, B 125, H 120

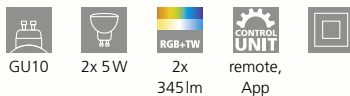

### 99675 CAMINALES-Z

ceiling light; steel, black  
Deckenleuchte; Stahl, schwarz  
plafonnier; acier, noir

L 240, B 240, H 120

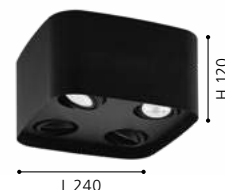
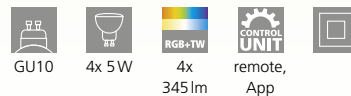



99669

LED



DESIGN  
HIGHLIGHT  
DETAIL



99671

LED



99672

LED

### 99669 SALICETO-Z

recessed light; aluminium, black  
Einbauleuchte; Alu, schwarz  
luminaire encastrable; aluminium, noir

H 46, Ø 88, ET 50

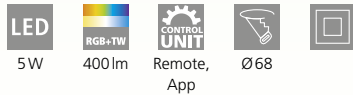

### 99671 SALICETO-Z

recessed light; aluminium, white  
Einbauleuchte; Alu, weiss  
luminaire encastrable; aluminium, blanc

H 46, Ø 88, ET 50

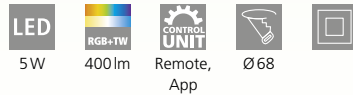

### 99672 SALICETO-Z

recessed light; aluminium, satin nickel  
Einbauleuchte; Alu, nickel-matt  
luminaire encastrable; aluminium, nickel mat

H 46, Ø 88, ET 50

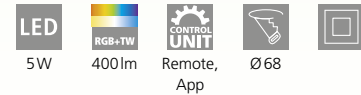



99677

LED



99676

LED



### 99677 LOMALTAS-Z

ceiling light; steel, wood, black, brown / plastic, white  
 Deckenleuchte; Stahl, Holz, schwarz, braun / Kunststoff, weiss  
 plafonnier; acier, bois, noir, marron / plastique, blanc

L 770, B 495, H 85



2x 16W



3800lm



Remote,  
App



9 002759 996772

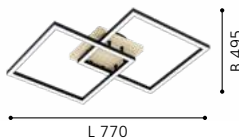

### 99676 LOMALTAS-Z

ceiling light; steel, wood, black, brown / plastic, white  
 Deckenleuchte; Stahl, Holz, schwarz, braun / Kunststoff, weiss  
 plafonnier; acier, bois, noir, marron / plastique, blanc

L 580, B 350



2x 16W



3800lm



Remote,  
App



9 002759 996765

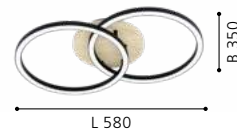





900019



900021



99588



### 900019 TABIANO-Z

mirror light; steel, chrome / plastic, white  
Spiegelleuchte; Stahl, chrom / Kunststoff, weiss  
applique pour miroir; acier, chrome / plastique, blanc

L 605, H 70, A 135

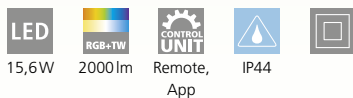

### 900021 TABIANO-Z

mirror light; steel, chrome / plastic, white  
Spiegelleuchte; Stahl, chrom / Kunststoff, weiss  
applique pour miroir; acier, chrome / plastique, blanc

L 905, H 70, A 135

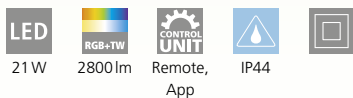

### 99588 JUAREZA-Z

mirror light; steel, white / mirror  
Spiegelleuchte; Stahl, weiss / Spiegel  
applique pour miroir; acier, blanc / miroir

L 700, H 500, A 55

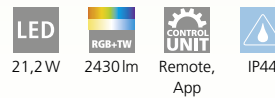

9 008606 221646



9 008606 221653



9 002759 995881





900079

LED



900081

LED



900082

LED



**900079 FRAIOLI-Z**

ceiling light; aluminium, black / plastic, white  
 Deckenleuchte; Alu, schwarz / Kunststoff, weiss  
 plafonnier; aluminium, noir / plastique, blanc

L 1055, B 120, H 65

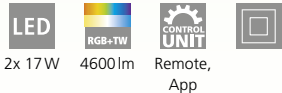

**900081 FRAIOLI-Z**

pendant light; aluminium, black / plastic, white  
 Hängeleuchte; Alu, schwarz / Kunststoff, weiss  
 luminaire en suspension; aluminium, noir / plastique, blanc

L 1055, B 100, H 1200

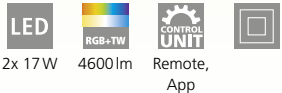

**900082 FRAIOLI-Z**

floor light; aluminium, black / plastic, white  
 Stehleuchte; Alu, schwarz / Kunststoff, weiss  
 lampadaire; aluminium, noir / plastique, blanc

H 1755, Base: B 280, T 280



9 008606 223565

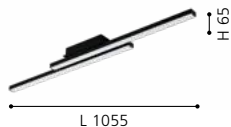

9 008606 223572



9 008606 223589





900076

LED



900077

LED



900078

LED

### 900076 FRAIOLI-Z

ceiling light; aluminium, satin nickel / plastic, white  
Deckenleuchte; Alu, nickel-matt / Kunststoff, weiss  
plafonnier; aluminium, nickel mat / plastique, blanc

L 1055, B 120, H 65

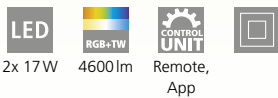

2x 17W 4600lm Remote, App



9 008606 223534



L 1055

### 900077 FRAIOLI-Z

pendant light; aluminium, satin nickel / plastic, white  
Hängeleuchte; Alu, nickel-matt / Kunststoff, weiss  
luminaire en suspension; aluminium, nickel mat / plastique, blanc

L 1055, B 100, H 1200

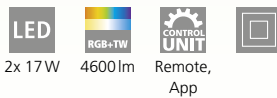

2x 17W 4600lm Remote, App



9 008606 223541

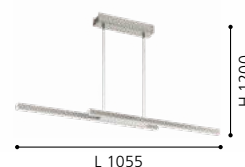

L 1055

### 900078 FRAIOLI-Z

floor light; aluminium, satin nickel / plastic, white  
Stehleuchte; Alu, nickel-matt / Kunststoff, weiss  
lampadaire; aluminium, nickel mat / plastique, blanc

H 1755, Base: B 280, T 280

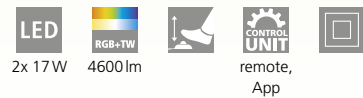

2x 17W 4600lm remote, App



9 008606 223558



B 280





900001



900002



900084



### 900001 TOTARI-Z

ceiling light; steel, white / plastic with crystal effect, white  
Deckenleuchte; Stahl, weiss / Kunststoff m. Kristalleffekt, weiss  
plafonnier; acier, blanc / plastique avec effet cristal, blanc

H 70, Ø 380

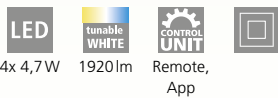

### 900002 TOTARI-Z

ceiling light; steel, white / plastic with crystal effect, white  
Deckenleuchte; Stahl, weiss / Kunststoff m. Kristalleffekt, weiss  
plafonnier; acier, blanc / plastique avec effet cristal, blanc

H 70, Ø 560



### 900084 TOTARI-Z

ceiling light; steel, white / plastic, white  
Deckenleuchte; Stahl, weiss / Kunststoff, weiss  
plafonnier; acier, blanc / plastique, blanc

H 70, Ø 380

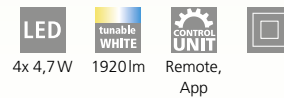

9 008606 221479



9 008606 221486



9 008606 225453



900085

LED



### 900085 TOTARI-Z

ceiling light; steel, white / plastic, white  
Deckenleuchte; Stahl, weiss / Kunststoff, weiss  
plafonnier; acier, blanc / plastique, blanc

H 70, Ø 560



4x 8,1 W



3600 lm



Remote,  
App



9 008606 225460





900083



900005



900006



### 900083 LANCIANO-Z

ceiling light; steel, white, transparent / plastic with crystal effect, white, chrome

Deckenleuchte; Stahl, weiss, transparent / Kunststoff m.Kristalleffekt, weiss, chrom

plafonnier; acier, blanc, transparent / plastique avec effet cristal, blanc, chrome  
H 80, Ø 450



4x 4,7 W

1920 lm

Remote,  
App

### 900005 LANCIANO-Z

ceiling light; steel, white, transparent / plastic with crystal effect, white, chrome

Deckenleuchte; Stahl, weiss, transparent / Kunststoff m.Kristalleffekt, weiss, chrom

plafonnier; acier, blanc, transparent / plastique avec effet cristal, blanc, chrome  
H 80, Ø 560



4x 8,1 W

3600 lm

Remote,  
App

### 900006 LANCIANO-Z

ceiling light; steel, white, transparent / plastic with crystal effect, white, chrome

Deckenleuchte; Stahl, weiss, transparent / Kunststoff m.Kristalleffekt, weiss, chrom

plafonnier; acier, blanc, transparent / plastique avec effet cristal, blanc, chrome  
H 95, Ø 770



38 W

4800 lm

Remote,  
App



9 008606 225446



9 008606 221516



9 008606 221523







900008

LED



900128

LED



900129

LED

### 900008 CAPASSO-Z

wall / ceiling light; steel, white / plastic, white, chrome  
Wand- / Deckenleuchte; Stahl, weiss / Kunststoff, weiss, chrom  
applique / plafonnier; acier, blanc / plastique, blanc, chrome

H 70, Ø 340



4x 3,9W



1680lm



Remote,  
App



9 008606 221547



### 900128 SILERAS-Z

ceiling light; steel, white / plastic with crystal effect, white  
Deckenleuchte; Stahl, weiss / Kunststoff m.Kristalleffekt, weiss  
plafonnier; acier, blanc / plastique avec effet cristal, blanc

H 60, Ø 430



3x 7,1W



2400lm



Remote,  
App



9 008606 226054



### 900129 SILERAS-Z

ceiling light; steel, white / plastic with crystal effect, white  
Deckenleuchte; Stahl, weiss / Kunststoff m.Kristalleffekt, weiss  
plafonnier; acier, blanc / plastique avec effet cristal, blanc

H 60, Ø 600



3x 11 W



3900lm



Remote,  
App



9 008606 226061





900025

LED

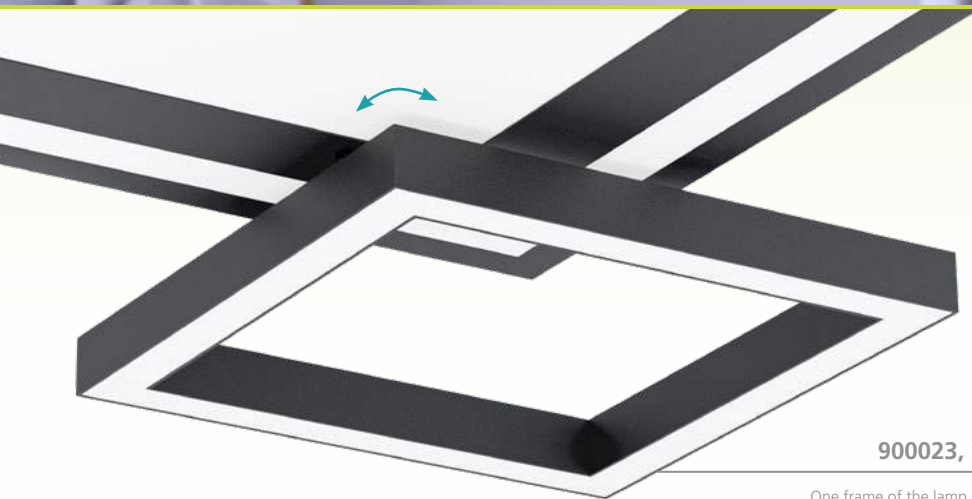

900023, 900025

One frame of the lamp is rotatable.

Ein Rahmen der Leuchte ist drehbar.

Un cadre de la lampe est rotatif.

### 900025 SAVATARILA-Z

ceiling light; steel, black / plastic, white  
Deckenleuchte; Stahl, schwarz / Kunststoff, weiss  
plafonnier; acier, noir / plastique, blanc

L 450, B 450, H 70



21 W



2400 lm



Remote,  
App

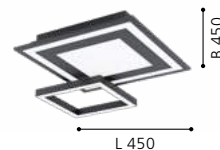



### 900023 SAVATARILA-Z

ceiling light; steel, white / plastic, white  
Deckenleuchte; Stahl, weiss / Kunststoff, weiss  
plafonnier; acier, blanc / plastique, blanc

L 450, B 450, H 70

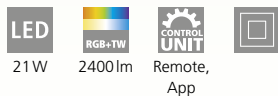

### 900022 SALITERAS-Z

ceiling light; steel, white / plastic, white  
Deckenleuchte; Stahl, weiss / Kunststoff, weiss  
plafonnier; acier, blanc / plastique, blanc

L 1160, B 160, H 50

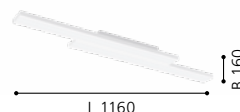

### 900024 SALITERAS-Z

ceiling light; steel, black / plastic, white  
Deckenleuchte; Stahl, schwarz / Kunststoff, weiss  
plafonnier; acier, noir / plastique, blanc

L 1160, B 160, H 50

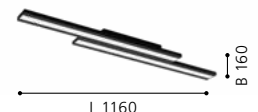
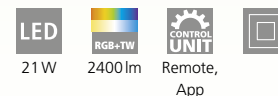





900054



900056



### TURCONA-Z

Frameless luminaire

Rahmenlose Leuchte

Luminaire sans cadre



### 900054 TURCONA-Z

ceiling light; steel, aluminium, white / plastic, white  
Deckenleuchte; Stahl, Alu, weiss / Kunststoff, weiss  
plafonnier; acier, aluminium, blanc / plastique, blanc

H 60, Ø 300

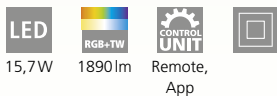

15,7W 1890lm Remote, App

### 900056 TURCONA-Z

ceiling light; steel, aluminium, white / plastic, white  
Deckenleuchte; Stahl, Alu, weiss / Kunststoff, weiss  
plafonnier; acier, aluminium, blanc / plastique, blanc

H 60, Ø 600

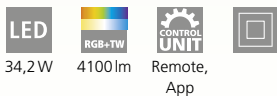

34,2W 4100lm Remote, App

### 900055 TURCONA-Z

ceiling light; steel, aluminium, white / plastic, white  
Deckenleuchte; Stahl, Alu, weiss / Kunststoff, weiss  
plafonnier; acier, aluminium, blanc / plastique, blanc

H 60, Ø 450



22,4W 2690lm Remote, App



9 008606 221905



9 008606 221929

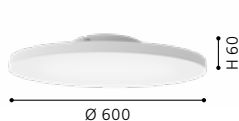

9 008606 221912





900055

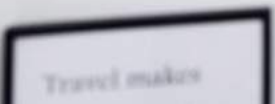



99548



99549



### 99548 HERRORA-Z

ceiling light; aluminium, white / plastic, white  
Deckenleuchte; Alu, weiss / Kunststoff, weiss  
plafonnier; aluminium, blanc / plastique, blanc

L 595, B 595, H 40



6x 5,3W 3960lm Remote, App



9 002759 995485



### 99549 HERRORA-Z

ceiling light; aluminium, white / plastic, white  
Deckenleuchte; Alu, weiss / Kunststoff, weiss  
plafonnier; aluminium, blanc / plastique, blanc

L 1200, B 300, H 40



3x 10,5W 4050lm Remote, App



9 002759 995492



### 99639 HERRORA-Z

ceiling light; aluminium, white / plastic, white  
Deckenleuchte; Alu, weiss / Kunststoff, weiss  
plafonnier; aluminium, blanc / plastique, blanc

L 450, B 450, H 40



22W 2600lm Remote, App



9 002759 996390







99639

LED



900057



900058



900059



**TURCONA-Z**

Frameless luminaire  
Rahmenlose Leuchte  
Luminaire sans cadre

**900057 TURCONA-Z**

ceiling light; steel, aluminium, white / plastic, white  
Deckenleuchte; Stahl, Alu, weiss / Kunststoff, weiss  
plafonnier; acier, aluminium, blanc / plastique, blanc

L 300, B 300, H 50

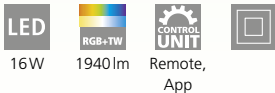

**900058 TURCONA-Z**

ceiling light; steel, aluminium, white / plastic, white  
Deckenleuchte; Stahl, Alu, weiss / Kunststoff, weiss  
plafonnier; acier, aluminium, blanc / plastique, blanc

L 450, B 450, H 50

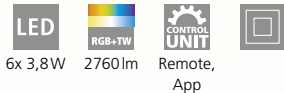

**900059 TURCONA-Z**

ceiling light; steel, aluminium, white / plastic, white  
Deckenleuchte; Stahl, Alu, weiss / Kunststoff, weiss  
plafonnier; acier, aluminium, blanc / plastique, blanc

L 600, B 600, H 50

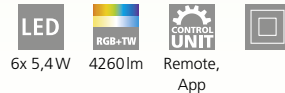

9 008606 221936



9 008606 221943

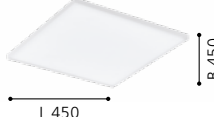

9 008606 221950

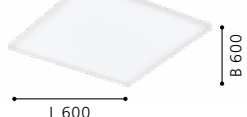



900062

LED



900061

LED

### 900062 TURCONA-Z

ceiling light; steel, aluminium, white / plastic, white  
Deckenleuchte; Stahl, Alu, weiss / Kunststoff, weiss  
plafonnier; acier, aluminium, blanc / plastique, blanc

L 1200, B 100, H 50

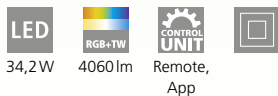

34,2W

4060lm

Remote,  
App

### 900061 TURCONA-Z

ceiling light; steel, aluminium, white / plastic, white  
Deckenleuchte; Stahl, Alu, weiss / Kunststoff, weiss  
plafonnier; acier, aluminium, blanc / plastique, blanc

L 1200, B 300, H 50

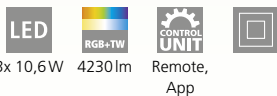

3x 10,6W

4230lm

Remote,  
App



9 008606 221974

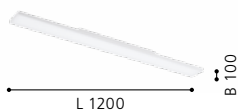

9 008606 221967

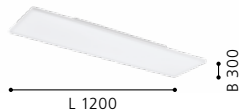



900044



900045



900046



### 900044 SALOBRENA-Z

ceiling light; aluminium, white / plastic, white  
Deckenleuchte; Alu, weiss / Kunststoff, weiss  
plafonnier; aluminium, blanc / plastique, blanc

L 300, B 300, H 50

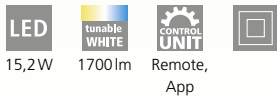

15,2W 1700lm Remote, App

### 900045 SALOBRENA-Z

ceiling light; aluminium, white / plastic, white  
Deckenleuchte; Alu, weiss / Kunststoff, weiss  
plafonnier; aluminium, blanc / plastique, blanc

L 450, B 450, H 50

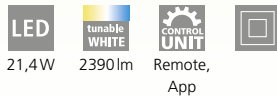

21,4W 2390lm Remote, App

### 900046 SALOBRENA-Z

ceiling light; aluminium, white / plastic, white  
Deckenleuchte; Alu, weiss / Kunststoff, weiss  
plafonnier; aluminium, blanc / plastique, blanc

L 595, B 595, H 50

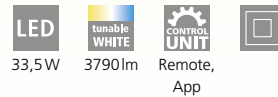

33,5W 3790lm Remote, App



9 008606 221813



9 008606 221820

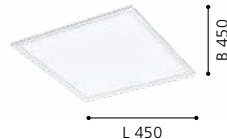

9 008606 221837







900047



900048



**900047 SALOBRENA-Z**

ceiling light; aluminium, white / plastic, white  
Deckenleuchte; Alu, weiss / Kunststoff, weiss  
plafonnier; aluminium, blanc / plastique, blanc

L 1200, B 300, H 50

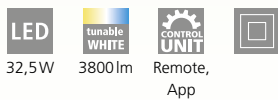

32,5W 3800lm Remote, App



9 008606 221844



**900048 SALOBRENA-Z**

ceiling light; aluminium, white / plastic, white  
Deckenleuchte; Alu, weiss / Kunststoff, weiss  
plafonnier; aluminium, blanc / plastique, blanc

L 1200, B 100, H 45

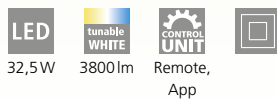

32,5W 3800lm Remote, App



9 008606 221851

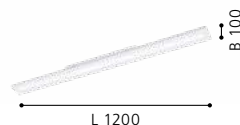

**ACCESSORIES INCLUDED**



900047



900046



900044



900045



Zubehör inkludiert  
Accessoires inclus



900049



900051



900052



### 900049 SALOBRENA-Z

ceiling light; aluminium, black / plastic, white  
Deckenleuchte; Alu, schwarz / Kunststoff, weiss  
plafonnier; aluminium, noir / plastique, blanc

L 300, B 300, H 50

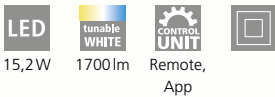

9 008606 221868



### 900051 SALOBRENA-Z

ceiling light; aluminium, black / plastic, white  
Deckenleuchte; Alu, schwarz / Kunststoff, weiss  
plafonnier; aluminium, noir / plastique, blanc

L 450, B 450, H 50

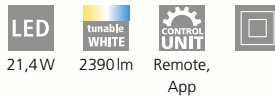

9 008606 221875

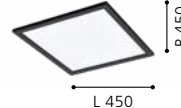

### 900052 SALOBRENA-Z

ceiling light; aluminium, black / plastic, white  
Deckenleuchte; Alu, schwarz / Kunststoff, weiss  
plafonnier; aluminium, noir / plastique, blanc

L 595, B 595, H 50

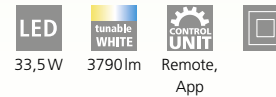

9 008606 221882





900053



900095



**900053 SALOBRENA-Z**

ceiling light; aluminium, black / plastic, white  
 Deckenleuchte; Alu, schwarz / Kunststoff, weiss  
 plafonnier; aluminium, noir / plastique, blanc

L 1200, B 300, H 50

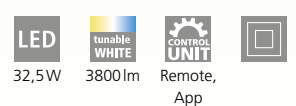

**900095 SALOBRENA-Z**

ceiling light; aluminium, steel, black / plastic, white  
 Deckenleuchte; Alu, Stahl, schwarz / Kunststoff, weiss  
 plafonnier; aluminium, acier, noir / plastique, blanc

L 1200, B 100, H 45



9 008606 221899



9 008606 225552

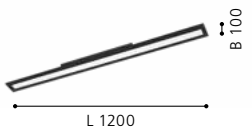

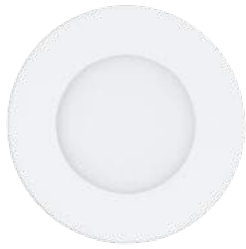

900099

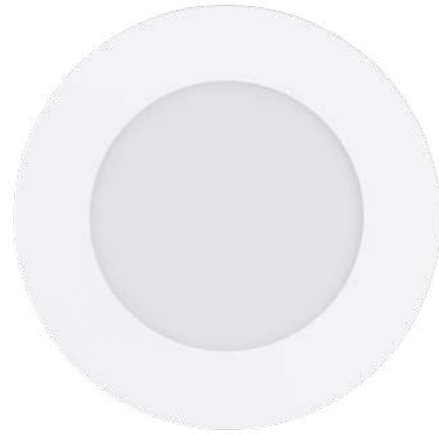

900101

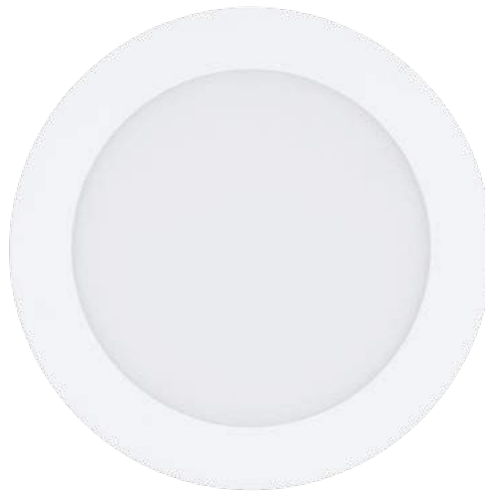

900102



### 900099 FUEVA-Z

recessed light; steel, white / plastic, white  
Einbauleuchte; Stahl, weiss / Kunststoff, weiss  
luminaire encastrable; acier, blanc / plastique, blanc

H 26, Ø 85



3x 2,8W 3x 360lm Remote, App Ø75 IP20, IP44



Ø 85

### 900101 FUEVA-Z

recessed light; steel, white / plastic, white  
Einbauleuchte; Stahl, weiss / Kunststoff, weiss  
luminaire encastrable; acier, blanc / plastique, blanc

H 26, Ø 120



5,4W 600lm Remote, App Ø105 IP20, IP44



Ø 120

### 900102 FUEVA-Z

recessed light; steel, white / plastic, white  
Einbauleuchte; Stahl, weiss / Kunststoff, weiss  
luminaire encastrable; acier, blanc / plastique, blanc

H 26, Ø 165



10,8W 1250lm Remote, App Ø155 IP20, IP44

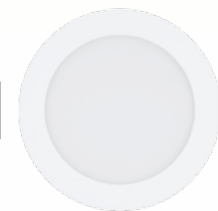

Ø 165





### 98842 FUEVA-Z

recessed light; aluminium, white / plastic, white  
 Einbauleuchte; Alu, weiss / Kunststoff, weiss  
 luminaire encastrable; aluminium, blanc / plastique, blanc

Ø 216, ET 26



16,5W



2250lm



Remote,  
App



Ø 205



IP20, IP44



Ø 216



900112



900111



900113



### 900111 FUEVA-Z

recessed light; steel, satin nickel / plastic, white  
Einbauleuchte; Stahl, nickel-matt / Kunststoff, weiss  
luminaire encastrable; acier, nickel mat / plastique, blanc

H 26, Ø 85



3x 2,8W



3x 360lm



Remote, App



Ø 75



IP20, IP44



9 008606 225668



Ø 85

### 900112 FUEVA-Z

recessed light; steel, satin nickel / plastic, white  
Einbauleuchte; Stahl, nickel-matt / Kunststoff, weiss  
luminaire encastrable; acier, nickel mat / plastique, blanc

H 26, Ø 120



5,4W



600lm



Remote, App



Ø 105



IP20, IP44



9 008606 225675



Ø 120

### 900113 FUEVA-Z

recessed light; steel, satin nickel / plastic, white  
Einbauleuchte; Stahl, nickel-matt / Kunststoff, weiss  
luminaire encastrable; acier, nickel mat / plastique, blanc

H 26, Ø 165



10,8W



1250lm



Remote, App



Ø 155



IP20, IP44



9 008606 225682



Ø 165



98844

LED

### 98844 FUEVA-Z

recessed light; aluminium, satin nickel / plastic, white  
Einbauleuchte; Alu, nickel-matt / Kunststoff, weiss  
luminaire encastrable; aluminium, nickel mat / plastique, blanc

Ø 216, ET 26

LED

16,5W

tunable  
WHITE

2250lm

CONTROL  
UNIT

Remote,  
App

Ø 205

IP20, IP44



Ø 216



900105



900106

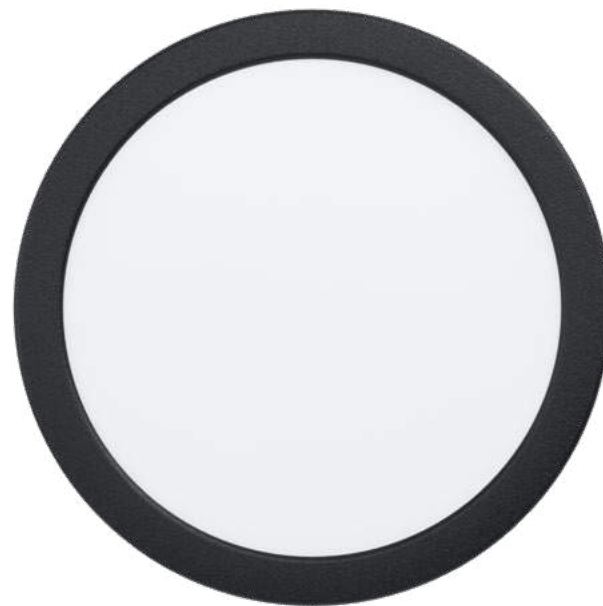

98846



### 900105 FUEVA-Z

recessed light; steel, black / plastic, white  
Einbauleuchte; Stahl, schwarz / Kunststoff, weiss  
luminaire encastrable; acier, noir / plastique, blanc

H 26, Ø 85



3x 2,8W 3x 360lm Remote, App Ø 75 IP20, IP44



9 008606 225613



Ø 85

### 900106 FUEVA-Z

recessed light; steel, black / plastic, white  
Einbauleuchte; Stahl, schwarz / Kunststoff, weiss  
luminaire encastrable; acier, noir / plastique, blanc

H 26, Ø 120



5,4W 600lm Remote, App Ø 105 IP20, IP44



9 008606 225620



Ø 120

### 98846 FUEVA-Z

recessed light; aluminium, black / plastic, white  
Einbauleuchte; Alu, schwarz / Kunststoff, weiss  
luminaire encastrable; aluminium, noir / plastique, blanc

Ø 216, ET 26



16,5W 2250lm Remote, App Ø 205 IP20, IP44



9 002759 988463



Ø 216





900107

LED

### 900107 FUEVA-Z

recessed light; steel, black / plastic, white

Einbauleuchte; Stahl, schwarz / Kunststoff, weiss

luminaire encastrable; acier, noir / plastique, blanc

H 26, Ø 166



10,8W



1250lm



Remote,  
App



Ø 155



IP20, IP44



9 008606 225637



Ø 166



900104

LED



900103

LED



98849

LED

### 900104 FUEVA-Z

surface-mounted light; steel, white / plastic, white  
Aufbauleuchte; Stahl, weiss / Kunststoff, weiss  
luminaire en saillie; acier, blanc / plastique, blanc

L 210, B 210, H 28

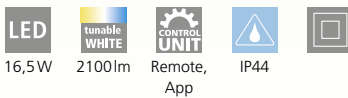

### 98849 FUEVA-Z

surface-mounted light; aluminium, white / plastic, white  
Aufbauleuchte; Alu, weiss / Kunststoff, weiss  
luminaire en saillie; aluminium, blanc / plastique, blanc

L 285, B 285, H 28

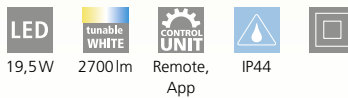

### 900103 FUEVA-Z

surface-mounted light; steel, white / plastic, white  
Aufbauleuchte; Stahl, weiss / Kunststoff, weiss  
luminaire en saillie; acier, blanc / plastique, blanc

H 28, Ø 210

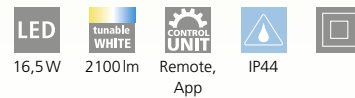



98843

LED



### 98843 FUEVA-Z

surface-mounted light; aluminium, white / plastic, white  
Aufbauleuchte; Alu, weiss / Kunststoff, weiss  
luminaire en saillie; aluminium, blanc / plastique, blanc

H 28, Ø 285

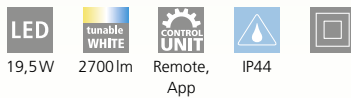

19,5W

2700lm

Remote,  
App

IP44



Ø 285





900114



900115



98845



### 900114 FUEVA-Z

surface-mounted light; steel, satin nickel / plastic, white  
Aufbauleuchte; Stahl, nickel-matt / Kunststoff, weiss  
luminaire en saillie; acier, nickel mat / plastique, blanc

H 28, Ø 210



16,5W



2100lm



Remote,  
App



IP44



### 98845 FUEVA-Z

surface-mounted light; aluminium, satin nickel / plastic, white  
Aufbauleuchte; Alu, nickel-matt / Kunststoff, weiss  
luminaire en saillie; aluminium, nickel mat / plastique, blanc

H 28, Ø 285



19,5W



2700lm



Remote,  
App



IP44



### 900115 FUEVA-Z

surface-mounted light; steel, satin nickel / plastic, white  
Aufbauleuchte; Stahl, nickel-matt / Kunststoff, weiss  
luminaire en saillie; acier, nickel mat / plastique, blanc

L 210, B 210, H 28



16,5W



2100lm



Remote,  
App



IP44



Ø 210



Ø 285



L 210

B 210





### 98852 FUEVA-Z

surface-mounted light; aluminium, satin nickel / plastic, white  
Aufbauleuchte; Alu, nickel-matt / Kunststoff, weiss  
luminaire en saillie; aluminium, nickel mat / plastique, blanc

L 285, B 285, H 28

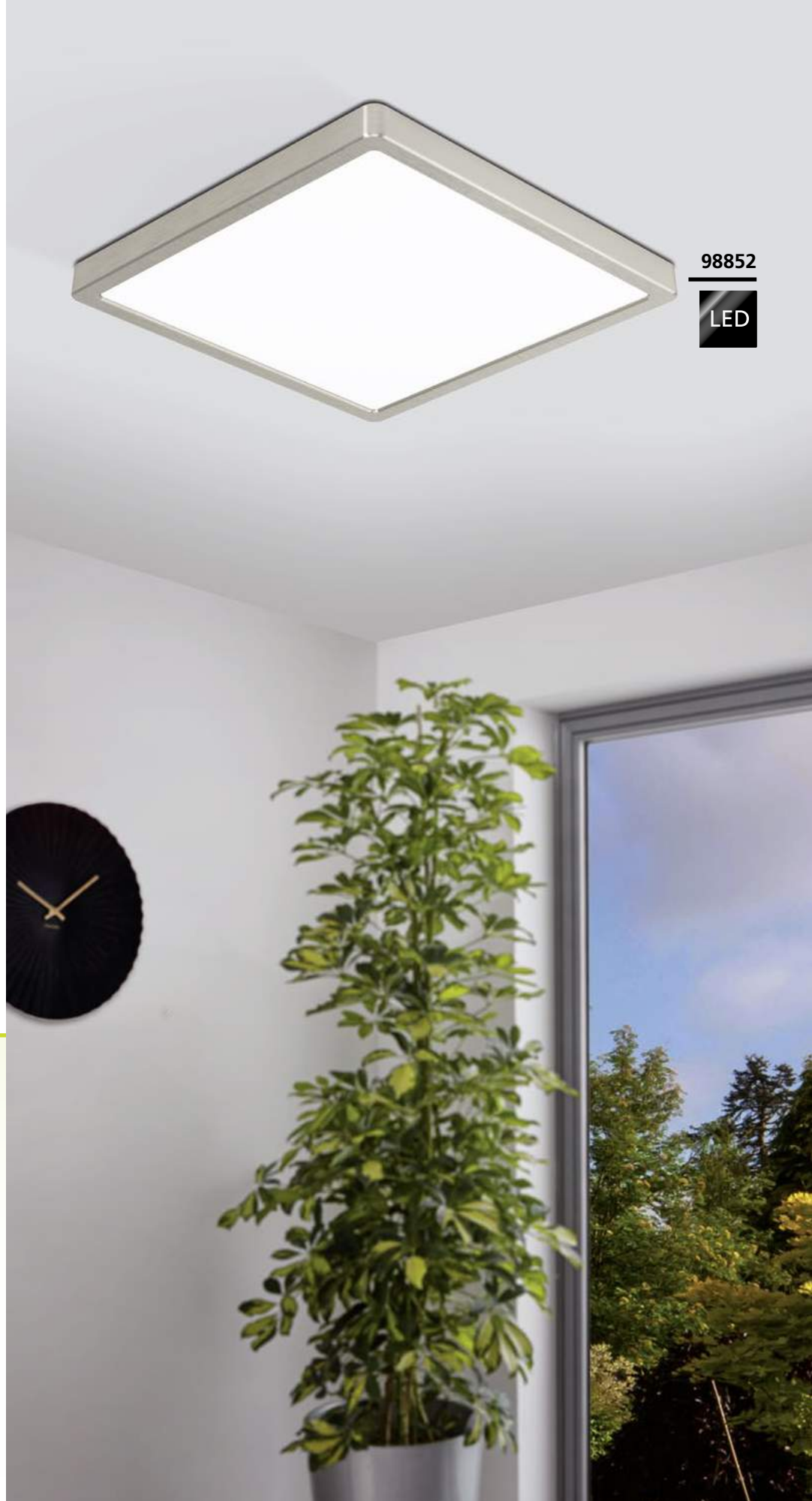
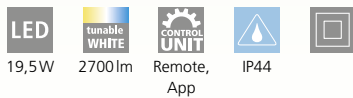

98852





900108



98854



98847



### 900108 FUEVA-Z

surface-mounted light; steel, black / plastic, white  
Aufbauleuchte; Stahl, schwarz / Kunststoff, weiss  
luminaire en saillie; acier, noir / plastique, blanc

H 28, Ø 210



16,5W



2100lm



Remote,  
App



IP44



### 98847 FUEVA-Z

surface-mounted light; aluminium, black / plastic, white  
Aufbauleuchte; Alu, schwarz / Kunststoff, weiss  
luminaire en saillie; aluminium, noir / plastique, blanc

H 28, Ø 285



19,5W



2700lm



Remote,  
App



IP44



### 98854 FUEVA-Z

surface-mounted light; aluminium, black / plastic, white  
Aufbauleuchte; Alu, schwarz / Kunststoff, weiss  
luminaire en saillie; aluminium, noir / plastique, blanc

L 285, B 285, H 28



19,5W



2700lm



Remote,  
App



IP44



Ø 210



Ø 285



L 285



900109

LED

### 900109 FUEVA-Z

surface-mounted light; steel, black / plastic, white  
Aufbauleuchte; Stahl, schwarz / Kunststoff, weiss  
luminaire en saillie; acier, noir / plastique, blanc

L 210, B 210, H 28

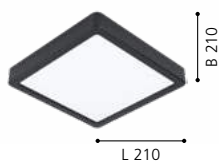
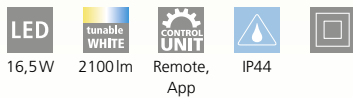

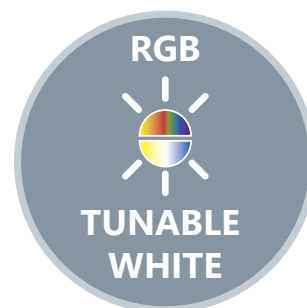
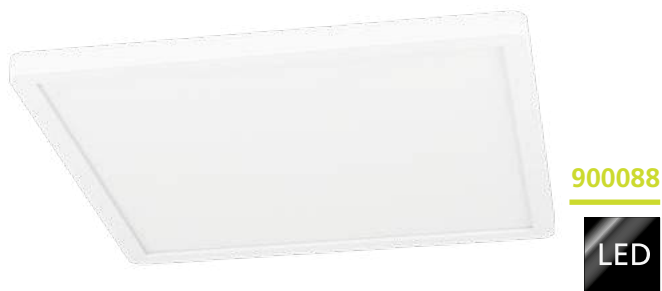

**900088 ROVITO-Z**

ceiling light; plastic, white / plastic, white  
Deckenleuchte; Kunststoff, weiss / Kunststoff, weiss  
plafonnier; plastique, blanc / plastique, blanc

L 295, B 295, H 25



**900089 ROVITO-Z**

ceiling light; plastic, white / plastic, white  
Deckenleuchte; Kunststoff, weiss / Kunststoff, weiss  
plafonnier; plastique, blanc / plastique, blanc

L 420, B 420, H 25



**900086 ROVITO-Z**

ceiling light; plastic, white / plastic, white  
Deckenleuchte; Kunststoff, weiss / Kunststoff, weiss  
plafonnier; plastique, blanc / plastique, blanc

H 25, Ø 295

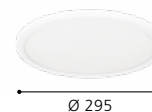
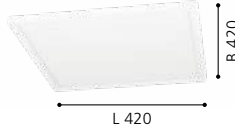





900087

LED

## 900087 ROVITO-Z

ceiling light; plastic, white / plastic, white

Deckenleuchte; Kunststoff, weiss / Kunststoff, weiss

plafonnier; plastique, blanc / plastique, blanc

H 25, Ø 420

LED

16,5W

RGB+TW

2400lm

CONTROL  
UNIT

Remote,  
App

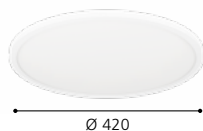



900093



900092



900094

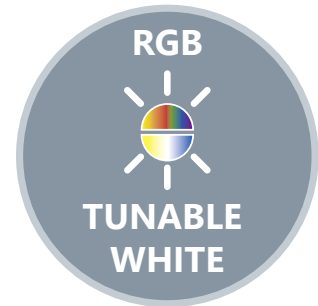

**900093 ROVITO-Z**

ceiling light; plastic, black / plastic, white  
 Deckenleuchte; Kunststoff, schwarz / Kunststoff, weiss  
 plafonnier; plastique, noir / plastique, blanc

L 295, B 295, H 25

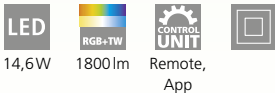

14,6W 1800lm Remote, App

**900094 ROVITO-Z**

ceiling light; plastic, black / plastic, white  
 Deckenleuchte; Kunststoff, schwarz / Kunststoff, weiss  
 plafonnier; plastique, noir / plastique, blanc

L 420, B 420, H 25

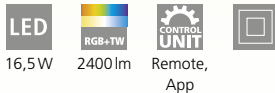

16,5W 2400lm Remote, App

**900092 ROVITO-Z**

ceiling light; plastic, black / plastic, white  
 Deckenleuchte; Kunststoff, schwarz / Kunststoff, weiss  
 plafonnier; plastique, noir / plastique, blanc

H 25, Ø 420

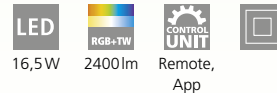

16,5W 2400lm Remote, App

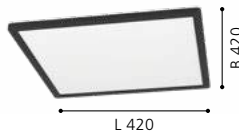
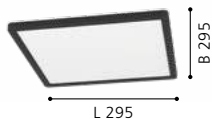



900091



### 900091 ROVITO-Z

ceiling light; plastic, black / plastic, white

Deckenleuchte; Kunststoff, schwarz / Kunststoff, weiss

plafonnier; plastique, noir / plastique, blanc

H 25, Ø 295



14,6W



1800lm



Remote,  
App



9 008606 225514

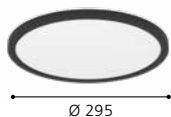



99686

99687



99684

99685



99684, 99686, 99687

Driver included

Treiber inkludiert

Chauffeur inclus



1x 1,5 m

99685

Extension for starter set 99684 without driver

Erweiterung für Starterset 99684 ohne Treiber

Rallonge pour kit de démarrage 99684 sans pilote

### 99686 LED STRIPE-Z

bar / strip light; plastic, white  
Leuchtband/-stab; Kunststoff, weiss  
bande lumineuse / bâton l; plastique, blanc

L 5000, B 10



9,2W



506lm



Remote,  
App



### 99687 LED STRIPE-Z

bar / strip light; plastic, white  
Leuchtband/-stab; Kunststoff, weiss  
bande lumineuse / bâton l; plastique, blanc

L 8000, B 12, H 3



8x 3W



2640lm



Remote,  
App



### 99684 LED STRIPE-Z

bar / strip light; plastic, white  
Leuchtband/-stab; Kunststoff, weiss  
bande lumineuse / bâton l; plastique, blanc

L 3000, B 8



13,5W



1350lm



Remote,  
App



9 002759 996864



L 5000



9 002759 996871



L 8000



9 002759 996840



L 3000





99687



### 99685 LED STRIPE-Z

bar / strip light; plastic, white  
 Leuchtband/-stab; Kunststoff, weiss  
 bande lumineuse / bâton l; plastique, blanc

L 2000, B 8

9W	900lm	Remote, App	



9 002759 996857

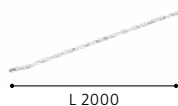

L 2000

## 12253 E27-LED-A60

<b>Dimensions</b> Abmessungen / dimensions	L 118, Ø 60
<b>Socket</b> Sockel / douille	E27
<b>Wattage</b> Wattage / puissance	9 W
<b>Light Colour</b> Lichtfarbe / couleur lumineuse	2700-6500K
<b>Operating voltage</b> Betriebsspannung / tension de fonctionnement	220-240V,50/60Hz
<b>Switching cycles</b> Schaltzyklen / cycles de fonctionnement	15.000 x
<b>Operating hours</b> Betriebsstunden / heures de fonctionnement	25.000 h
<b>Colour rendering index</b> Farbwiedergabeindex / L'indice de restitution de couleurs	>80



**9W**

**806 lm**  
LUMEN

A+ RGB+TW

9W ~ 60W

9 002759 122539

## 12254 E27-LED-G95

<b>Dimensions</b> Abmessungen / dimensions	L 136, Ø 95
<b>Socket</b> Sockel / douille	E27
<b>Wattage</b> Wattage / puissance	13 W
<b>Light Colour</b> Lichtfarbe / couleur lumineuse	2700-6500K
<b>Operating voltage</b> Betriebsspannung / tension de fonctionnement	220-240V,50/60Hz
<b>Switching cycles</b> Schaltzyklen / cycles de fonctionnement	25.000 x
<b>Operating hours</b> Betriebsstunden / heures de fonctionnement	20.000 h
<b>Colour rendering index</b> Farbwiedergabeindex / L'indice de restitution de couleurs	>80



**13W**

**1300 lm**  
LUMEN

A+ RGB+TW

13W ~ 88W

9 002759 122546

## 12252 E14-LED-P45

<b>Dimensions</b> Abmessungen / dimensions	L 90, Ø 45
<b>Socket</b> Sockel / douille	E14
<b>Wattage</b> Wattage / puissance	5 W
<b>Light Colour</b> Lichtfarbe / couleur lumineuse	2700-6500K
<b>Operating voltage</b> Betriebsspannung / tension de fonctionnement	220-240V,50/60Hz
<b>Switching cycles</b> Schaltzyklen / cycles de fonctionnement	25.000 x
<b>Operating hours</b> Betriebsstunden / heures de fonctionnement	20.000 h
<b>Colour rendering index</b> Farbwiedergabeindex / L'indice de restitution de couleurs	>80



**5W**

**470 lm**  
LUMEN

A+ RGB+TW

5W ~ 40W

9 002759 122522

## 12251 GU10-LED

<b>Dimensions</b> Abmessungen / dimensions	L 59, Ø 50
<b>Socket</b> Sockel / douille	GU10
<b>Wattage</b> Wattage / puissance	5W
<b>Light Colour</b> Lichtfarbe / couleur lumineuse	2700-6500K
<b>Operating voltage</b> Betriebsspannung / tension de fonctionnement	220-240V,50/60Hz
<b>Switching cycles</b> Schaltzyklen / cycles de fonctionnement	25.000 x
<b>Operating hours</b> Betriebsstunden / heures de fonctionnement	20.000 h
<b>Colour rendering index</b> Farbwiedergabeindex / L'indice de restitution de couleurs	>80
<b>beamangle</b> Ausstrahlwinkel / angle de rayonnement	45°



5W

345 lm  
LUMEN



5W



50W



## 12226 E27-LED-A60

<b>Dimensions</b> Abmessungen / dimensions	L 105, Ø 60
<b>Socket</b> Sockel / douille	E27
<b>Wattage</b> Wattage / puissance	6 W
<b>Light Colour</b> Lichtfarbe / couleur lumineuse	2700K
<b>Operating voltage</b> Betriebsspannung / tension de fonctionnement	220-240V,50/60Hz
<b>Switching cycles</b> Schaltzyklen / cycles de fonctionnement	25.000 x
<b>Operating hours</b> Betriebsstunden / heures de fonctionnement	20.000 h
<b>Colour rendering index</b> Farbwiedergabeindex / L'indice de restitution de couleurs	>80



**6W**

**806 lm**  
LUMEN

A++ warm WHITE

6W ~ 60W

9 002759 122263

## 12227 E27-LED-ST64

<b>Dimensions</b> Abmessungen / dimensions	L 142, Ø 64
<b>Socket</b> Sockel / douille	E27
<b>Wattage</b> Wattage / puissance	6 W
<b>Light Colour</b> Lichtfarbe / couleur lumineuse	2700K
<b>Operating voltage</b> Betriebsspannung / tension de fonctionnement	220-240V,50/60Hz
<b>Switching cycles</b> Schaltzyklen / cycles de fonctionnement	25.000 x
<b>Operating hours</b> Betriebsstunden / heures de fonctionnement	20.000 h
<b>Colour rendering index</b> Farbwiedergabeindex / L'indice de restitution de couleurs	>80



**6W**

**806 lm**  
LUMEN

A++ warm WHITE

6W ~ 60W

9 002759 122270

## 12228 E27-LED-G80

<b>Dimensions</b> Abmessungen / dimensions	L 120, Ø 80
<b>Socket</b> Sockel / douille	E27
<b>Wattage</b> Wattage / puissance	6 W
<b>Light Colour</b> Lichtfarbe / couleur lumineuse	2700K
<b>Operating voltage</b> Betriebsspannung / tension de fonctionnement	220-240V,50/60Hz
<b>Switching cycles</b> Schaltzyklen / cycles de fonctionnement	25.000 x
<b>Operating hours</b> Betriebsstunden / heures de fonctionnement	20.000 h
<b>Colour rendering index</b> Farbwiedergabeindex / L'indice de restitution de couleurs	>80



**6W**

**806 lm**  
LUMEN

A++ warm WHITE

6W ~ 60W

9 002759 122287



## 12229 E27-LED-G95

<b>Dimensions</b> Abmessungen / dimensions	L 140, Ø 95
<b>Socket</b> Sockel / douille	E27
<b>Wattage</b> Wattage / puissance	6W
<b>Light Colour</b> Lichtfarbe / couleur lumineuse	2700K
<b>Operating voltage</b> Betriebsspannung / tension de fonctionnement	220-240V,50/60Hz
<b>Switching cycles</b> Schaltzyklen / cycles de fonctionnement	25.000 x
<b>Operating hours</b> Betriebsstunden / heures de fonctionnement	20.000 h
<b>Colour rendering index</b> Farbwiedergabeindex / L'indice de restitution de couleurs	>80



6W

806 lm  
LUMEN

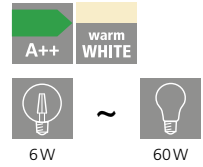

6W 60W



## 12231 E27-LED-A60

<b>Dimensions</b> Abmessungen / dimensions	L 105, Ø 60
<b>Socket</b> Sockel / douille	E27
<b>Wattage</b> Wattage / puissance	6W
<b>Light Colour</b> Lichtfarbe / couleur lumineuse	4000K
<b>Operating voltage</b> Betriebsspannung / tension de fonctionnement	220-240V,50/60Hz
<b>Switching cycles</b> Schaltzyklen / cycles de fonctionnement	25.000 x
<b>Operating hours</b> Betriebsstunden / heures de fonctionnement	20.000 h
<b>Colour rendering index</b> Farbwiedergabeindex / L'indice de restitution de couleurs	>80



6W

806 lm  
LUMEN

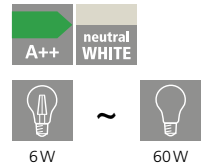

6W 60W



## 12232 E27-LED-ST64

<b>Dimensions</b> Abmessungen / dimensions	L 142, Ø 64
<b>Socket</b> Sockel / douille	E27
<b>Wattage</b> Wattage / puissance	6W
<b>Light Colour</b> Lichtfarbe / couleur lumineuse	4000K
<b>Operating voltage</b> Betriebsspannung / tension de fonctionnement	220-240V,50/60Hz
<b>Switching cycles</b> Schaltzyklen / cycles de fonctionnement	25.000 x
<b>Operating hours</b> Betriebsstunden / heures de fonctionnement	20.000 h
<b>Colour rendering index</b> Farbwiedergabeindex / L'indice de restitution de couleurs	>80



6W

806 lm  
LUMEN

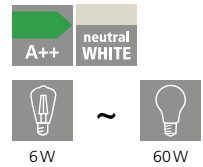

6W 60W



## 12233 E27-LED-G80

<b>Dimensions</b> Abmessungen / dimensions	L 120, Ø 80
<b>Socket</b> Sockel / douille	E27
<b>Wattage</b> Wattage / puissance	6 W
<b>Light Colour</b> Lichtfarbe / couleur lumineuse	4000K
<b>Operating voltage</b> Betriebsspannung / tension de fonctionnement	220-240V,50/60Hz
<b>Switching cycles</b> Schaltzyklen / cycles de fonctionnement	25.000 x
<b>Operating hours</b> Betriebsstunden / heures de fonctionnement	20.000 h
<b>Colour rendering index</b> Farbwiedergabeindex / L'indice de restitution de couleurs	>80

DIMMABLE  
VIA REMOTE  
AND APP



6W

806 lm  
LUMEN

A++ neutral  
WHITE



9 002759 122331

## 12234 E27-LED-G95

<b>Dimensions</b> Abmessungen / dimensions	L 140, Ø 95
<b>Socket</b> Sockel / douille	E27
<b>Wattage</b> Wattage / puissance	6 W
<b>Light Colour</b> Lichtfarbe / couleur lumineuse	4000K
<b>Operating voltage</b> Betriebsspannung / tension de fonctionnement	220-240V,50/60Hz
<b>Switching cycles</b> Schaltzyklen / cycles de fonctionnement	25.000 x
<b>Operating hours</b> Betriebsstunden / heures de fonctionnement	20.000 h
<b>Colour rendering index</b> Farbwiedergabeindex / L'indice de restitution de couleurs	>80

DIMMABLE  
VIA REMOTE  
AND APP



6W

806 lm  
LUMEN

A++ neutral  
WHITE



9 002759 122348

## 12235 E27-LED-A60

<b>Dimensions</b> Abmessungen / dimensions	L 105, Ø 60
<b>Socket</b> Sockel / douille	E27
<b>Wattage</b> Wattage / puissance	6 W
<b>Light Colour</b> Lichtfarbe / couleur lumineuse	2200-6500K
<b>Operating voltage</b> Betriebsspannung / tension de fonctionnement	220-240V,50/60Hz
<b>Switching cycles</b> Schaltzyklen / cycles de fonctionnement	25.000 x
<b>Operating hours</b> Betriebsstunden / heures de fonctionnement	20.000 h
<b>Colour rendering index</b> Farbwiedergabeindex / L'indice de restitution de couleurs	>80

DIMMABLE  
VIA REMOTE  
AND APP



6W

806 lm  
LUMEN

A++ tunable  
WHITE



9 002759 122355

## 12236 E27-LED-ST64

<b>Dimensions</b> Abmessungen / dimensions	L 142, Ø 64
<b>Socket</b> Sockel / douille	E27
<b>Wattage</b> Wattage / puissance	6W
<b>Light Colour</b> Lichtfarbe / couleur lumineuse	2200-6500K
<b>Operating voltage</b> Betriebsspannung / tension de fonctionnement	220-240V,50/60Hz
<b>Switching cycles</b> Schaltzyklen / cycles de fonctionnement	25.000 x
<b>Operating hours</b> Betriebsstunden / heures de fonctionnement	20.000 h
<b>Colour rendering index</b> Farbwiedergabeindex / L'indice de restitution de couleurs	>80



6W

806 lm  
LUMEN



## 12237 E27-LED-G80

<b>Dimensions</b> Abmessungen / dimensions	L 120, Ø 80
<b>Socket</b> Sockel / douille	E27
<b>Wattage</b> Wattage / puissance	6W
<b>Light Colour</b> Lichtfarbe / couleur lumineuse	2200-6500K
<b>Operating voltage</b> Betriebsspannung / tension de fonctionnement	220-240V,50/60Hz
<b>Switching cycles</b> Schaltzyklen / cycles de fonctionnement	25.000 x
<b>Operating hours</b> Betriebsstunden / heures de fonctionnement	20.000 h
<b>Colour rendering index</b> Farbwiedergabeindex / L'indice de restitution de couleurs	>80



6W

806 lm  
LUMEN



## 12239 E27-LED-G95

<b>Dimensions</b> Abmessungen / dimensions	L 140, Ø 95
<b>Socket</b> Sockel / douille	E27
<b>Wattage</b> Wattage / puissance	6W
<b>Light Colour</b> Lichtfarbe / couleur lumineuse	2200-6500K
<b>Operating voltage</b> Betriebsspannung / tension de fonctionnement	220-240V,50/60Hz
<b>Switching cycles</b> Schaltzyklen / cycles de fonctionnement	25.000 x
<b>Operating hours</b> Betriebsstunden / heures de fonctionnement	20.000 h
<b>Colour rendering index</b> Farbwiedergabeindex / L'indice de restitution de couleurs	>80



6W

806 lm  
LUMEN



## 12221 E27-LED-A60

<b>Dimensions</b> Abmessungen / dimensions	L 105, Ø 60
<b>Socket</b> Sockel / douille	E27
<b>Wattage</b> Wattage / puissance	5,5 W
<b>Light Colour</b> Lichtfarbe / couleur lumineuse	2200K
<b>Operating voltage</b> Betriebsspannung / tension de fonctionnement	220-240V,50/60Hz
<b>Switching cycles</b> Schaltzyklen / cycles de fonctionnement	25.000 x
<b>Operating hours</b> Betriebsstunden / heures de fonctionnement	20.000 h
<b>Colour rendering index</b> Farbwiedergabeindex / L'indice de restitution de couleurs	>80



**5,5W**

**500 lm**  
LUMEN

A+ warm WHITE

5,5W ~ 41W

9 002759 122218

## 12222 E27-LED-ST64

<b>Dimensions</b> Abmessungen / dimensions	L 142, Ø 64
<b>Socket</b> Sockel / douille	E27
<b>Wattage</b> Wattage / puissance	5,5 W
<b>Light Colour</b> Lichtfarbe / couleur lumineuse	2200K
<b>Operating voltage</b> Betriebsspannung / tension de fonctionnement	220-240V,50/60Hz
<b>Switching cycles</b> Schaltzyklen / cycles de fonctionnement	25.000 x
<b>Operating hours</b> Betriebsstunden / heures de fonctionnement	20.000 h
<b>Colour rendering index</b> Farbwiedergabeindex / L'indice de restitution de couleurs	>80



**5,5W**

**500 lm**  
LUMEN

A+ warm WHITE

5,5W ~ 41W

9 002759 122225

## 12223 E27-LED-G80

<b>Dimensions</b> Abmessungen / dimensions	L 120, Ø 80
<b>Socket</b> Sockel / douille	E27
<b>Wattage</b> Wattage / puissance	5,5 W
<b>Light Colour</b> Lichtfarbe / couleur lumineuse	2200K
<b>Operating voltage</b> Betriebsspannung / tension de fonctionnement	220-240V,50/60Hz
<b>Switching cycles</b> Schaltzyklen / cycles de fonctionnement	15.000 x
<b>Operating hours</b> Betriebsstunden / heures de fonctionnement	20.000 h
<b>Colour rendering index</b> Farbwiedergabeindex / L'indice de restitution de couleurs	>80



**5,5W**

**500 lm**  
LUMEN

A+ warm WHITE

5,5W ~ 41W

9 002759 122232



## 12224 E27-LED-G95

<b>Dimensions</b> Abmessungen / dimensions	L 140, Ø 95
<b>Socket</b> Sockel / douille	E27
<b>Wattage</b> Wattage / puissance	5,5W
<b>Light Colour</b> Lichtfarbe / couleur lumineuse	2200K
<b>Operating voltage</b> Betriebsspannung / tension de fonctionnement	220-240V,50/60Hz
<b>Switching cycles</b> Schaltzyklen / cycles de fonctionnement	25.000 x
<b>Operating hours</b> Betriebsstunden / heures de fonctionnement	20.000 h
<b>Colour rendering index</b> Farbwiedergabeindex / L'indice de restitution de couleurs	>80



5,5W

500 lm  
LUMEN

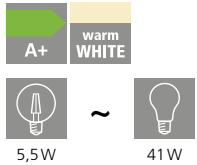

5,5W

41W



## 12225 E27-LED-G125

<b>Dimensions</b> Abmessungen / dimensions	L 172, Ø 125
<b>Socket</b> Sockel / douille	E27
<b>Wattage</b> Wattage / puissance	6W
<b>Light Colour</b> Lichtfarbe / couleur lumineuse	2200K
<b>Operating voltage</b> Betriebsspannung / tension de fonctionnement	220-240V,50/60Hz
<b>Switching cycles</b> Schaltzyklen / cycles de fonctionnement	25.000 x
<b>Operating hours</b> Betriebsstunden / heures de fonctionnement	20.000 h
<b>Colour rendering index</b> Farbwiedergabeindex / L'indice de restitution de couleurs	>80



6W

650 lm  
LUMEN

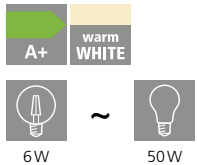

6W

50W



## 12241 E27-LED-A60

<b>Dimensions</b> Abmessungen / dimensions	L 105, Ø 60
<b>Socket</b> Sockel / douille	E27
<b>Wattage</b> Wattage / puissance	5,5 W
<b>Light Colour</b> Lichtfarbe / couleur lumineuse	2200-6500K
<b>Operating voltage</b> Betriebsspannung / tension de fonctionnement	220-240V,50/60Hz
<b>Switching cycles</b> Schaltzyklen / cycles de fonctionnement	25.000 x
<b>Operating hours</b> Betriebsstunden / heures de fonctionnement	20.000 h
<b>Colour rendering index</b> Farbwiedergabeindex / L'indice de restitution de couleurs	>80



**5,5W**

**400 lm**  
LUMEN

A+ tunable WHITE

5,5W ~ 35W

9 002759 122416

## 12242 E27-LED-ST64

<b>Dimensions</b> Abmessungen / dimensions	L 142, Ø 64
<b>Socket</b> Sockel / douille	E27
<b>Wattage</b> Wattage / puissance	5,5 W
<b>Light Colour</b> Lichtfarbe / couleur lumineuse	2200-6500K
<b>Operating voltage</b> Betriebsspannung / tension de fonctionnement	220-240V,50/60Hz
<b>Switching cycles</b> Schaltzyklen / cycles de fonctionnement	25.000 x
<b>Operating hours</b> Betriebsstunden / heures de fonctionnement	20.000 h
<b>Colour rendering index</b> Farbwiedergabeindex / L'indice de restitution de couleurs	>80



**5,5W**

**400 lm**  
LUMEN

A+ tunable WHITE

5,5W ~ 35W

9 002759 122423

## 12243 E27-LED-G80

<b>Dimensions</b> Abmessungen / dimensions	L 120, Ø 80
<b>Socket</b> Sockel / douille	E27
<b>Wattage</b> Wattage / puissance	5,5 W
<b>Light Colour</b> Lichtfarbe / couleur lumineuse	2200-6500K
<b>Operating voltage</b> Betriebsspannung / tension de fonctionnement	220-240V,50/60Hz
<b>Switching cycles</b> Schaltzyklen / cycles de fonctionnement	25.000 x
<b>Operating hours</b> Betriebsstunden / heures de fonctionnement	20.000 h
<b>Colour rendering index</b> Farbwiedergabeindex / L'indice de restitution de couleurs	>80



**5,5W**

**400 lm**  
LUMEN

A+ tunable WHITE

5,5W ~ 35W

9 002759 122430

## 12244 E27-LED-G95

<b>Dimensions</b> Abmessungen / dimensions	L 140, Ø 95
<b>Socket</b> Sockel / douille	E27
<b>Wattage</b> Wattage / puissance	5,5W
<b>Light Colour</b> Lichtfarbe / couleur lumineuse	2200-6500K
<b>Operating voltage</b> Betriebsspannung / tension de fonctionnement	220-240V,50/60Hz
<b>Switching cycles</b> Schaltzyklen / cycles de fonctionnement	25.000 x
<b>Operating hours</b> Betriebsstunden / heures de fonctionnement	20.000 h
<b>Colour rendering index</b> Farbwiedergabeindex / L'indice de restitution de couleurs	>80



5,5W

400 lm  
LUMEN



## 12245 E27-LED-G125

<b>Dimensions</b> Abmessungen / dimensions	L 172, Ø 125
<b>Socket</b> Sockel / douille	E27
<b>Wattage</b> Wattage / puissance	5,5W
<b>Light Colour</b> Lichtfarbe / couleur lumineuse	2200-6500K
<b>Operating voltage</b> Betriebsspannung / tension de fonctionnement	220-240V,50/60Hz
<b>Switching cycles</b> Schaltzyklen / cycles de fonctionnement	25.000 x
<b>Operating hours</b> Betriebsstunden / heures de fonctionnement	20.000 h
<b>Colour rendering index</b> Farbwiedergabeindex / L'indice de restitution de couleurs	>80



5,5W

400 lm  
LUMEN



## 12255 E27-LED-A60

<b>Dimensions</b> Abmessungen / dimensions	L 105, Ø 60
<b>Socket</b> Sockel / douille	E27
<b>Wattage</b> Wattage / puissance	6 W
<b>Light Colour</b> Lichtfarbe / couleur lumineuse	4000K
<b>Operating voltage</b> Betriebsspannung / tension de fonctionnement	220-240V,50/60Hz
<b>Switching cycles</b> Schaltzyklen / cycles de fonctionnement	25.000 x
<b>Operating hours</b> Betriebsstunden / heures de fonctionnement	20.000 h
<b>Colour rendering index</b> Farbwiedergabeindex / L'indice de restitution de couleurs	>80



**6W**  
**806 lm**  
LUMEN

**A++** neutral  
WHITE



## 12256 E27-LED-ST64

<b>Dimensions</b> Abmessungen / dimensions	L 142, Ø 64
<b>Socket</b> Sockel / douille	E27
<b>Wattage</b> Wattage / puissance	5,5 W
<b>Light Colour</b> Lichtfarbe / couleur lumineuse	2200K
<b>Operating voltage</b> Betriebsspannung / tension de fonctionnement	220-240V,50/60Hz
<b>Switching cycles</b> Schaltzyklen / cycles de fonctionnement	25.000 x
<b>Operating hours</b> Betriebsstunden / heures de fonctionnement	20.000 h
<b>Colour rendering index</b> Farbwiedergabeindex / L'indice de restitution de couleurs	>80



**5,5W**  
**500 lm**  
LUMEN

**A+** warm  
WHITE



## 12257 E27-LED-A60

<b>Dimensions</b> Abmessungen / dimensions	L 105, Ø 60
<b>Socket</b> Sockel / douille	E27
<b>Wattage</b> Wattage / puissance	6 W
<b>Light Colour</b> Lichtfarbe / couleur lumineuse	4000K
<b>Operating voltage</b> Betriebsspannung / tension de fonctionnement	220-240V,50/60Hz
<b>Switching cycles</b> Schaltzyklen / cycles de fonctionnement	25.000 x
<b>Operating hours</b> Betriebsstunden / heures de fonctionnement	20.000 h
<b>Colour rendering index</b> Farbwiedergabeindex / L'indice de restitution de couleurs	>80

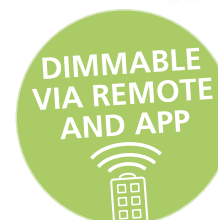

**6W**  
**806 lm**  
LUMEN

**A++** neutral  
WHITE





## 12258 E27-LED-ST64

<b>Dimensions</b> Abmessungen / dimensions	L 142, Ø 64
<b>Socket</b> Sockel / douille	E27
<b>Wattage</b> Wattage / puissance	5,5W
<b>Light Colour</b> Lichtfarbe / couleur lumineuse	2200K
<b>Operating voltage</b> Betriebsspannung / tension de fonctionnement	220-240V,50/60Hz
<b>Switching cycles</b> Schaltzyklen / cycles de fonctionnement	25.000 x
<b>Operating hours</b> Betriebsstunden / heures de fonctionnement	20.000 h
<b>Colour rendering index</b> Farbwiedergabeindex / L'indice de restitution de couleurs	>80



incl./inkl./inclus

5,5W

500 lm  
LUMEN

A+

warm  
WHITE



5,5W



41W







































# EGLO Access

Let **light** follow  
your **life**



# OVERVIEW

EGLO ACCESS

							
ACCESS REMOTE p. 82	ZUBIETA-A p. 82	ZUBIETA-A p. 82	ZUBIETA-A p. 83	ZUBIETA-A p. 84	ZUBIETA-A p. 84	ZUBIETA-A p. 84	SILERAS-A p. 85
							
SILERAS-A p. 85	FRANIA-A p. 86	FRANIA-A p. 86	FRANIA-A p. 86	FRANIA-A p. 87	MORATICA-A p. 87	MORATICA-A p. 87	SARSINA-A p. 88
							
SARSINA-A p. 88	SARSINA-A p. 88	SALOBRENA-A p. 90	SALOBRENA-A p. 90	SALOBRENA-A p. 90	SALOBRENA-A p. 91	SALOBRENA-A p. 91	FUEVA-A p. 92
							
FUEVA-A p. 92	FUEVA-A p. 92	LED-STRIPE-A p. 94	LED-STRIPE-A p. 94	LM_LED_E14 p. 96	LM_LED_E14 p. 96	LM_LED_E27 p. 96	LM_LED_E27 p. 97
							
LM_LED_E27 p. 98	LM_LED_GU10 p. 98	LM_LED_E27 p. 98	LM_LED_GU10 p. 99				

# FUNCTIONS

## FUNKTIONEN FONCTIONS

Relax with warm light and leave the hustle and bustle of everyday life behind you. Concentrate on your work or dispel fatigue, with neutral white light the energy level is replenished. EGLO Access offers these possibilities and many more. All functions and highlights at a glance:

- › It works with radio frequency technology and allows 360 degree control
- › Controllable up to a distance of 10 meters
- › Up to 8 different items can be connected
- › Easy handling thanks to 4 ready-made settings and 2 memory functions

NIGHT LIGHT

RELAX MODE

WORK MODE

SWITCH OFF AFTER 30 MINUTES

Mit warmem Licht entspannen und die Hektik des Alltages hinter sich lassen. Konzentriert arbeiten oder die Müdigkeit vertreiben, mit neutralweißem Licht wird das Energielevel wieder aufgefüllt. Diese Möglichkeiten und noch viele mehr bietet Ihnen EGLO Access. Alle Funktionen und Highlights auf einem Blick:

- › Es arbeitet mit Funktechnologie und ermöglicht eine 360-Grad-Steuerung
- › Steuerbar bis zu einer Entfernung von 10 Metern
- › Bis zu 8 verschiedene Artikel können miteinander verbunden werden
- › Einfache Handhabung durch 4 vorgefertigte Einstellungen und 2 Speicherfunktionen

NACHTLICHT

ENTSPANNUNGSMODUS

ARBEITSMODUS

AUSSCHALTEN NACH 30 MINUTEN

Lumière chaude pour se détendre et laisser l'agitation quotidienne derrière soi. Travailler de manière concentrée ou chasser la fatigue, avec une lumière blanche neutre, le niveau d'énergie est rétabli. EGLO Access vous offre ces possibilités et bien d'autres encore. Toutes les fonctions et les points forts en un coup d'œil :

- › Il fonctionne avec la technologie de la fréquence radio et permet un contrôle à 360 degrés
- › Contrôlable jusqu'à une distance de 10 mètres
- › Jusqu'à 8 articles différents peuvent être connectés ensemble
- › Manipulation facile grâce à 4 réglages prêts à l'emploi et 2 fonctions mémoire

VEILLEUSE

MODE DE DÉCOMPRESSION

MODE DE TRAVAIL

EXTINCTION APRÈS 30 MINUTES

## COLOUR TEMPERATURES SCALE / FARBTEMPERATUREN SKALA / ÉCHELLE DES TEMPÉRATURES DE COULEUR



# REMOTE CONTROL

FERNBEDIENUNG  
TÉLÉCOMMANDE

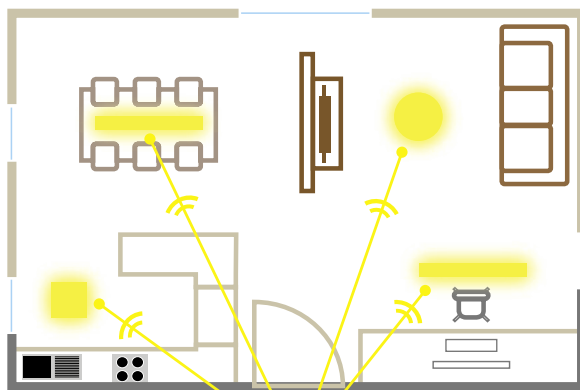

no internet necessary  
kein Internet erforderlich  
nul besoin d'internet



Control up to 8 EGLO Access luminaires  
Bis zu 8 EGLO Access Leuchten steuerbar  
Contrôle jusqu'à 8 luminaires EGLO Access



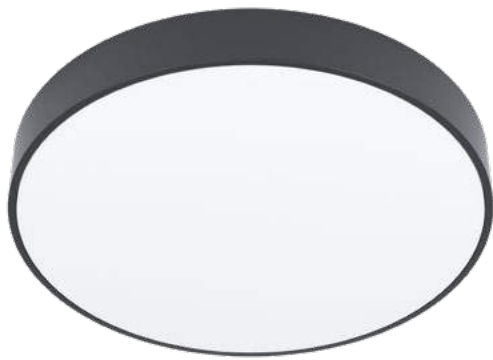

98894

LED

incl./inkl./inclus



33199



incl./inkl./inclus

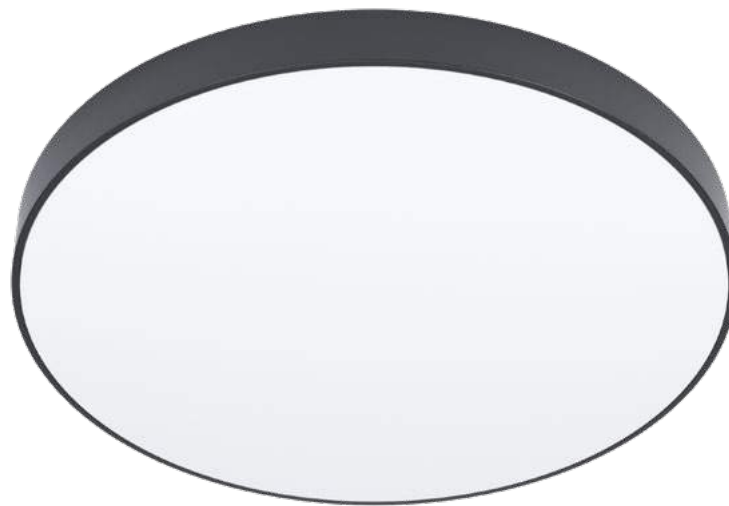

98895

LED

incl./inkl./inclus



### 33199 ACCESS REMOTE

remote control; plastic, anthracite  
Fernbedienung; Kunststoff, anthrazit  
Télécommande; plastique, anthracite

L 118, B 45



ACCU  
CR2032

### 98894 ZUBIETA-A

surface-mounted light; steel, black / plastic, white  
Aufbauleuchte; Stahl, schwarz / Kunststoff, weiss  
luminaire en saillie; acier, noir / plastique, blanc

H 40, Ø 300



18W



tunable  
WHITE  
1900lm



remote



CONTROL  
UNIT

### 98895 ZUBIETA-A

surface-mounted light; steel, black / plastic, white  
Aufbauleuchte; Stahl, schwarz / Kunststoff, weiss  
luminaire en saillie; acier, noir / plastique, blanc

H 40, Ø 450



24W



tunable  
WHITE  
2300lm



remote



CONTROL  
UNIT



9 002759 331993



9 002759 988944



9 002759 988951





98896

LED

incl./inkl./inclus



**98896 ZUBIETA-A**

surface-mounted light; steel, black / plastic, white  
Aufbauleuchte; Stahl, schwarz / Kunststoff, weiss  
luminaire en saillie; acier, noir / plastique, blanc

H 40, Ø 595



36W



3700lm



remote



9 002759 988968



Ø 595

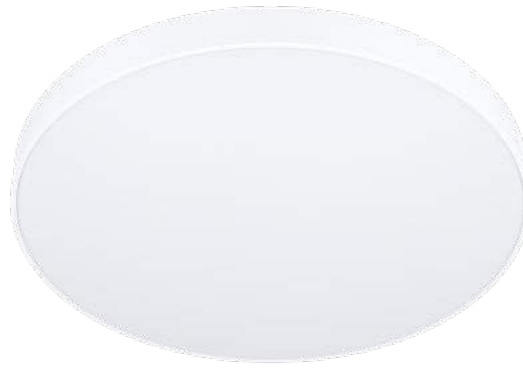

98892



98891



98893



### 98891 ZUBIETA-A

surface-mounted light; steel, white / plastic, white  
Aufbauleuchte; Stahl, weiss / Kunststoff, weiss  
luminaire en saillie; acier, blanc / plastique, blanc

H 40, Ø 300



18W



1900lm



remote

### 98892 ZUBIETA-A

surface-mounted light; steel, white / plastic, white  
Aufbauleuchte; Stahl, weiss / Kunststoff, weiss  
luminaire en saillie; acier, blanc / plastique, blanc

H 40, Ø 450



24W



2300lm



remote

### 98893 ZUBIETA-A

surface-mounted light; steel, white / plastic, white  
Aufbauleuchte; Stahl, weiss / Kunststoff, weiss  
luminaire en saillie; acier, blanc / plastique, blanc

H 40, Ø 595



36W



3700lm



remote





98227



98228



### 98227 SILERAS-A

wall / ceiling light; steel, white / plastic with crystal effect, white  
Wand- / Deckenleuchte; Stahl, weiss / Kunststoff m.Kristalleffekt, weiss  
applique / plafonnier; acier, blanc / plastique avec effet cristal, blanc

H 80, Ø 450



### 98228 SILERAS-A

wall / ceiling light; steel, white / plastic with crystal effect, white  
Wand- / Deckenleuchte; Stahl, weiss / Kunststoff m.Kristalleffekt, weiss  
applique / plafonnier; acier, blanc / plastique avec effet cristal, blanc

H 85, Ø 600





98236



incl./inkl./inclus



98294



incl./inkl./inclus



98237



incl./inkl./inclus

### 98294 FRANIA-A

wall / ceiling light; steel, white / plastic with crystal effect, white  
Wand- / Deckenleuchte; Stahl, weiss / Kunststoff m.Kristalleffekt, weiss  
applique / plafonnier; acier, blanc / plastique avec effet cristal, blanc

H 55, Ø 300



12W



1050lm



remote



IP44

### 98236 FRANIA-A

wall / ceiling light; steel, white / plastic with crystal effect, white  
Wand- / Deckenleuchte; Stahl, weiss / Kunststoff m.Kristalleffekt, weiss  
applique / plafonnier; acier, blanc / plastique avec effet cristal, blanc

H 55, Ø 400



24W



1800lm



remote

### 98237 FRANIA-A

wall / ceiling light; steel, white / plastic with crystal effect, white  
Wand- / Deckenleuchte; Stahl, weiss / Kunststoff m.Kristalleffekt, weiss  
applique / plafonnier; acier, blanc / plastique avec effet cristal, blanc

H 75, Ø 570



36W



3300lm



remote



9 002759 982942



H 55

Ø 300



9 002759 982362



H 55

Ø 400



9 002759 982379



H 75

Ø 570





98219



incl./inkl./inclus



98235



incl./inkl./inclus



98223



incl./inkl./inclus

### 98235 FRANIA-A

wall / ceiling light; steel, white / plastic, white  
Wand- / Deckenleuchte; Stahl, weiss / Kunststoff, weiss  
applique / plafonnier; acier, blanc / plastique, blanc

H 55, Ø 300



12W



1050lm



remote

### 98219 MORATICA-A

ceiling light; steel, plastic, white, transparent / plastic with  
crystal effect, white, silver  
Deckenleuchte; Stahl, Kunststoff, weiss, transparent / Kunststoff  
m.Kristalleffekt, weiss, silber  
plafonnier; acier, plastique, blanc, transparent / plastique avec  
effet cristal, blanc, argent  
H 75, Ø 570



36W



3300lm



remote

### 98223 MORATICA-A

ceiling light; steel, plastic, white, transparent / plastic with  
crystal effect, white, silver  
Deckenleuchte; Stahl, Kunststoff, weiss, transparent / Kunststoff  
m.Kristalleffekt, weiss, silber  
plafonnier; acier, plastique, blanc, transparent / plastique avec  
effet cristal, blanc, argent  
H 85, Ø 760



60W



5900lm



remote



9 002759 982355



9 002759 982195



9 002759 982232





98207



98208



**98207 SARSINA-A**

ceiling light; aluminium, white / plastic, white  
Deckenleuchte; Alu, weiss / Kunststoff, weiss  
plafonnier; aluminium, blanc / plastique, blanc

H 50, Ø 300



**98208 SARSINA-A**

ceiling light; aluminium, white / plastic, white  
Deckenleuchte; Alu, weiss / Kunststoff, weiss  
plafonnier; aluminium, blanc / plastique, blanc

H 50, Ø 450



**98209 SARSINA-A**

ceiling light; aluminium, white / plastic, white  
Deckenleuchte; Alu, weiss / Kunststoff, weiss  
plafonnier; aluminium, blanc / plastique, blanc

H 50, Ø 600



9 002759 982072



9 002759 982089



9 002759 982096





98209

LED

incl./inkl./inclus





98205



incl./inkl./inclus

98206



incl./inkl./inclus



98297



incl./inkl./inclus

### 98205 SALOBRENA-A

ceiling light; aluminium, white / plastic, white  
Deckenleuchte; Alu, weiss / Kunststoff, weiss  
plafonnier; aluminium, blanc / plastique, blanc

L 1200, B 300, H 50



### 98206 SALOBRENA-A

ceiling light; aluminium, white / plastic, white  
Deckenleuchte; Alu, weiss / Kunststoff, weiss  
plafonnier; aluminium, blanc / plastique, blanc

L 1195, B 100, H 50



### 98297 SALOBRENA-A

ceiling light; aluminium, white / plastic, white  
Deckenleuchte; Alu, weiss / Kunststoff, weiss  
plafonnier; aluminium, blanc / plastique, blanc

L 450, B 450, H 50



9 002759 982058



9 002759 982065

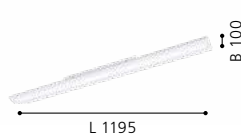

9 002759 982973





98201



incl./inkl./inclus



98203



incl./inkl./inclus



### 98201 SALOBRENA-A

ceiling light; aluminium, white / plastic, white  
Deckenleuchte; Alu, weiss / Kunststoff, weiss  
plafonnier; aluminium, blanc / plastique, blanc

L 300, B 300, H 50



14W

1850lm

remote

### 98203 SALOBRENA-A

ceiling light; aluminium, white / plastic, white  
Deckenleuchte; Alu, weiss / Kunststoff, weiss  
plafonnier; aluminium, blanc / plastique, blanc

L 600, B 600, H 50



30W

4000lm

remote



9 002759 982010



9 002759 982034







98292



98293



## FUEVA-A

These luminaires inspire with their extremely flat and elegant design.

Diese Leuchten begeistern durch ihre extrem flache und elegante Bauweise.

Ces lumières enthousiasment par la méthode de construction extrêmement plate et élégante.

### 98292 FUEVA-A

surface-mounted light; aluminium, white / plastic, white  
 Aufbauleuchte; Alu, weiss / Kunststoff, weiss  
 luminaire en saillie; aluminium, blanc / plastique, blanc

H 30, Ø 225



14W



2000lm



remote



### 98293 FUEVA-A

surface-mounted light; aluminium, white / plastic, white  
 Aufbauleuchte; Alu, weiss / Kunststoff, weiss  
 luminaire en saillie; aluminium, blanc / plastique, blanc

H 30, Ø 300



20W



2650lm



remote



### 98212 FUEVA-A

recessed light; aluminium, white / plastic, white  
 Einbauleuchte; Alu, weiss / Kunststoff, weiss  
 luminaire encastrable; aluminium, blanc / plastique, blanc

Ø 120, ET 30



5W



700lm



remote



Ø 108



9 002759 982928



Ø 225



9 002759 982935



Ø 300



9 002759 982126



Ø 120





98212

LED

incl./inkl./inclus





98295



98296



98295, 98296

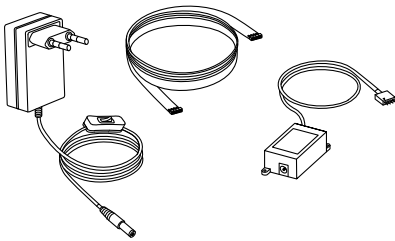

98295, 98296

These articles include a remote control.

Bei diesen Artikeln ist eine Fernbedienung inkludiert.

Ces articles comprennent une télécommande.



**98295 LED-STRIPE-A**

bar / strip light; plastic, white  
 Leuchtband/-stab; Kunststoff, weiss  
 bande lumineuse / bâton l; plastique, blanc

L 2000, B 10, H 3



**98296 LED-STRIPE-A**

bar / strip light; plastic, white  
 Leuchtband/-stab; Kunststoff, weiss  
 bande lumineuse / bâton l; plastique, blanc

L 5000, B 10, H 3

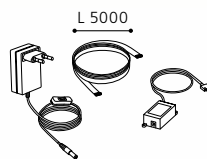
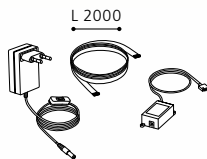



98296

LED



## 11804 E14-LED-P45

<b>Dimensions</b> Abmessungen / dimensions	L 90, Ø 45
<b>Socket</b> Sockel / douille	E14
<b>Wattage</b> Wattage / puissance	5 W
<b>Light Colour</b> Lichtfarbe / couleur lumineuse	2700-6500K
<b>Operating voltage</b> Betriebsspannung / tension de fonctionnement	220-240V,50/60Hz
<b>Switching cycles</b> Schaltzyklen / cycles de fonctionnement	15.000 x
<b>Operating hours</b> Betriebsstunden / heures de fonctionnement	25.000 h
<b>Colour rendering index</b> Farbwiedergabeindex / L'indice de restitution de couleurs	>80



## 11805 E14-LED-P45

<b>Dimensions</b> Abmessungen / dimensions	L 90, Ø 45
<b>Socket</b> Sockel / douille	E14
<b>Wattage</b> Wattage / puissance	5 W
<b>Light Colour</b> Lichtfarbe / couleur lumineuse	2700-6500K
<b>Operating voltage</b> Betriebsspannung / tension de fonctionnement	220-240V,50/60Hz
<b>Switching cycles</b> Schaltzyklen / cycles de fonctionnement	15.000 x
<b>Operating hours</b> Betriebsstunden / heures de fonctionnement	25.000 h
<b>Colour rendering index</b> Farbwiedergabeindex / L'indice de restitution de couleurs	>80



## 11806 E27-LED-A60

<b>Dimensions</b> Abmessungen / dimensions	L 118, Ø 60
<b>Socket</b> Sockel / douille	E27
<b>Wattage</b> Wattage / puissance	9 W
<b>Light Colour</b> Lichtfarbe / couleur lumineuse	2700-6500K
<b>Operating voltage</b> Betriebsspannung / tension de fonctionnement	220-240V,50/60Hz
<b>Switching cycles</b> Schaltzyklen / cycles de fonctionnement	15.000 x
<b>Operating hours</b> Betriebsstunden / heures de fonctionnement	25.000 h
<b>Colour rendering index</b> Farbwiedergabeindex / L'indice de restitution de couleurs	>80





## 11807 E27-LED-A60

<b>Dimensions</b> Abmessungen / dimensions	L 118, Ø 60
<b>Socket</b> Sockel / douille	E27
<b>Wattage</b> Wattage / puissance	9W
<b>Light Colour</b> Lichtfarbe / couleur lumineuse	2700-6500K
<b>Operating voltage</b> Betriebsspannung / tension de fonctionnement	220-240V,50/60Hz
<b>Switching cycles</b> Schaltzyklen / cycles de fonctionnement	15.000 x
<b>Operating hours</b> Betriebsstunden / heures de fonctionnement	25.000 h
<b>Colour rendering index</b> Farbwiedergabeindex / L'indice de restitution de couleurs	>80



## 11809 E27-LED-G95

<b>Dimensions</b> Abmessungen / dimensions	L 140, Ø 95
<b>Socket</b> Sockel / douille	E27
<b>Wattage</b> Wattage / puissance	12 W
<b>Light Colour</b> Lichtfarbe / couleur lumineuse	2700-6500K
<b>Operating voltage</b> Betriebsspannung / tension de fonctionnement	220-240V,50/60Hz
<b>Switching cycles</b> Schaltzyklen / cycles de fonctionnement	15.000 x
<b>Operating hours</b> Betriebsstunden / heures de fonctionnement	25.000 h
<b>Colour rendering index</b> Farbwiedergabeindex / L'indice de restitution de couleurs	>80



## 11811 E27-LED-G95

<b>Dimensions</b> Abmessungen / dimensions	L 140, Ø 95
<b>Socket</b> Sockel / douille	E27
<b>Wattage</b> Wattage / puissance	12 W
<b>Light Colour</b> Lichtfarbe / couleur lumineuse	2700-6500K
<b>Operating voltage</b> Betriebsspannung / tension de fonctionnement	220-240V,50/60Hz
<b>Switching cycles</b> Schaltzyklen / cycles de fonctionnement	100.000 x
<b>Operating hours</b> Betriebsstunden / heures de fonctionnement	25.000 h
<b>Colour rendering index</b> Farbwiedergabeindex / L'indice de restitution de couleurs	>80



## 11802 GU10-LED

<b>Dimensions</b> Abmessungen / dimensions	L 56, Ø 50
<b>Socket</b> Sockel / douille	GU10
<b>Wattage</b> Wattage / puissance	5 W
<b>Light Colour</b> Lichtfarbe / couleur lumineuse	2700-6500K
<b>Operating voltage</b> Betriebsspannung / tension de fonctionnement	220-240V,50/60Hz
<b>Switching cycles</b> Schaltzyklen / cycles de fonctionnement	15.000 x
<b>Operating hours</b> Betriebsstunden / heures de fonctionnement	25.000 h
<b>Colour rendering index</b> Farbwiedergabeindex / L'indice de restitution de couleurs	>80



## 11801 GU10-LED

<b>Dimensions</b> Abmessungen / dimensions	L 56, Ø 50
<b>Socket</b> Sockel / douille	GU10
<b>Wattage</b> Wattage / puissance	5W
<b>Light Colour</b> Lichtfarbe / couleur lumineuse	2700-6500K
<b>Operating voltage</b> Betriebsspannung / tension de fonctionnement	220-240V,50/60Hz
<b>Switching cycles</b> Schaltzyklen / cycles de fonctionnement	15.000 x
<b>Operating hours</b> Betriebsstunden / heures de fonctionnement	25.000 h
<b>Colour rendering index</b> Farbwiedergabeindex / L'indice de restitution de couleurs	>80



5W

315 lm  
LUMEN



5W



38W



# LIGHTING FAMILIES

FABRIC LUMINAIRES

STOFFLEUCHTEN

LUMINAIRES À TEXTIL

## SIMPLE CLASSINESS -

The textile luminaires with their unusual designs are perfectly trendy and bring cosiness to every home. Selected textiles in natural shades and clear shapes form the basis of a friendly and tasteful living environment in our textile luminaires. Inner coatings in sophisticated gold and classical silver add an air of luxury.



## SCHLICHTE ELEGANZ -

Die Stoffleuchten mit ihrem außergewöhnlichen Design sind voll im Trend und sorgen für Gemütlichkeit in jedem Zuhause. Bei den Stoffleuchten bilden ausgesuchte Stoffe in Naturtönen und klare Formgebungen die Grundlage für eine freundliche und geschmackvolle Wohnumgebung. Für einen Hauch von Luxus sorgen die Innenbeschichtungen in edlem Gold und klassischem Silber.



## ÉLÉGANCE SIMPLE -

Les luminaires en étoffe avec leur design extraordinaire sont très tendance et assurent un confort dans chaque maison. Chez les luminaires en étoffe, des étoffes sélectionnées dans des tons naturels et des formes claires forment la base d'un cadre de vie convivial et de bon goût. Les revêtements internes en or fin et en argent classique ajoutent une touche de luxe.





# OVERVIEW

## LIGHTING FAMILIES / FABRIC



This product is available in different colors and shapes./ Dieser Artikel ist in unterschiedlichen Farben und Formen verfügbar.  
Cet article est disponible en différentes couleurs et formes.



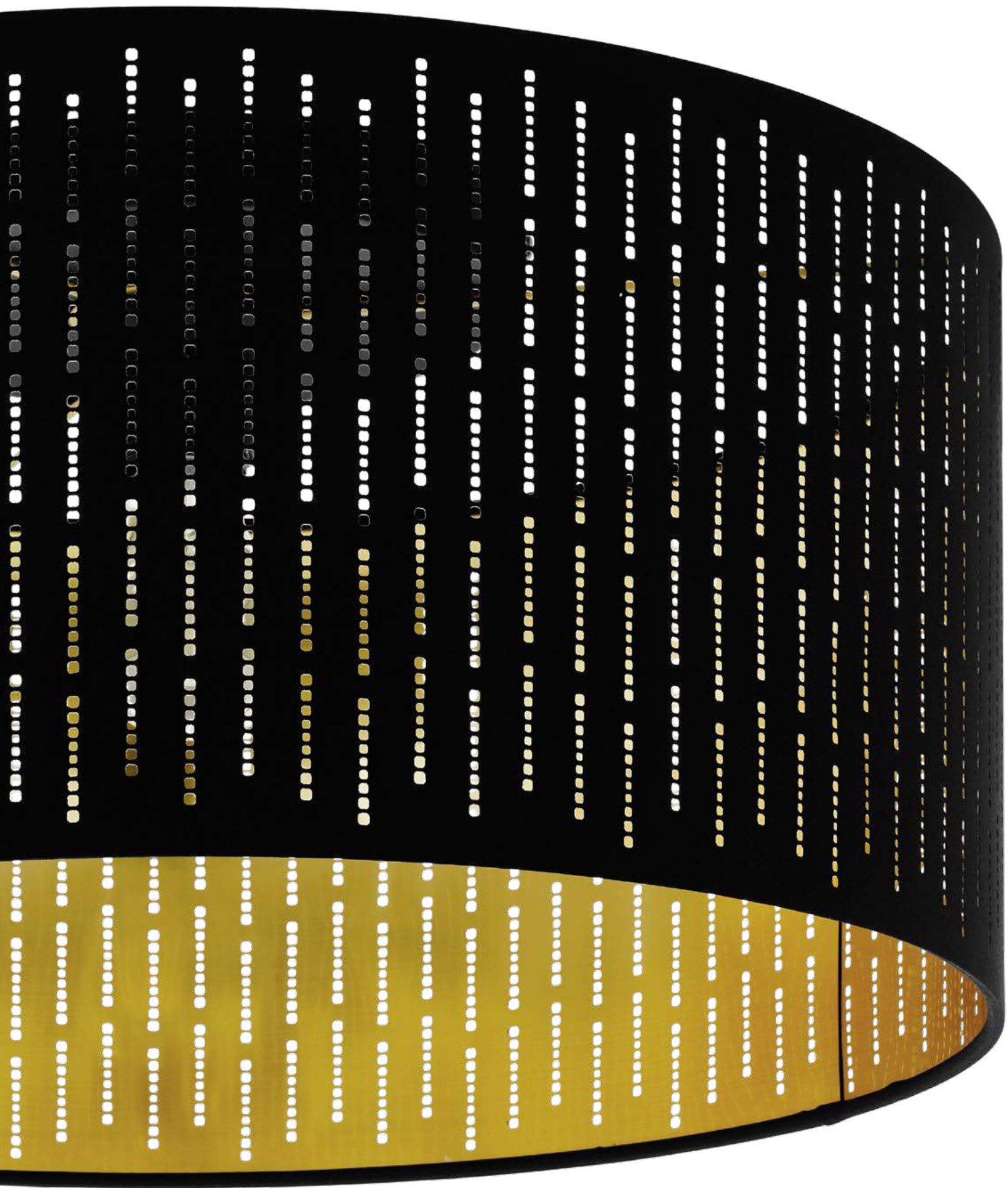

# FABRIC MATERIALS

## COATING



coating, silver  
Beschichtung, silber  
revêtement, argent



coating, gold  
Beschichtung, gold  
revêtement, or

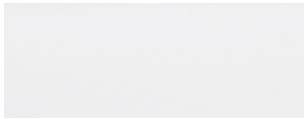

coating, white  
Beschichtung, weiß  
revêtement, blanc



coating, copper  
Beschichtung, kupfer  
revêtement, cuivre



coating, black  
Beschichtung, schwarz  
revêtement, noir



coating, brass  
Beschichtung, messing  
revêtement, laiton

## SHADES

### GLOSSY



fabric, glossy black  
Textil, samtglänzend schwarz  
tissu, velours noir brillant



fabric, glossy taupe  
Textil, samtglänzend taupe  
tissu, velours taupe brillant



fabric, glossy cappuccino  
Textil, samtglänzend cappuccino  
tissu, velours cappuccino brillant



fabric, glossy grey  
Textil, samtglänzend grau  
tissu, velours gris brillant

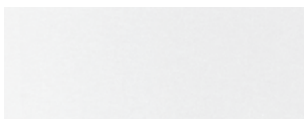

fabric, glossy white  
Textil, samtglänzend weiss  
tissu, velours blanc brillant



fabric, glossy gold  
Textil, samtglänzend gold  
tissu, velours or brillant

### MAT



fabric, mat black  
Textil, matt schwarz  
tissu, tapis noir

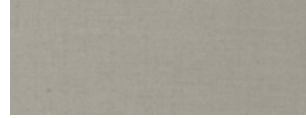

fabric, mat taupe  
Textil, matt taupe  
tissu, tapis taupe



fabric, mat anthracite-brown  
Textil, matt anthrazit-braun  
tissu, tapis anthracite-marron



fabric, mat grey  
Textil, matt grau  
tissu, tapis gris

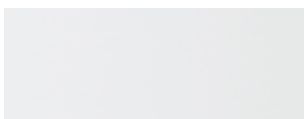

fabric, mat white  
Textil, matt weiss  
tissu, tapis blanc

### LINEN



linen, grey  
Leinen, grau  
lin, gris



linen, brown  
Leinen, braun  
lin, marron



97777

LED

incl./inkl./inclus



97782

LED

incl./inkl./inclus



97779

LED

incl./inkl./inclus

### 97777 ROMAO 1

ceiling light; steel, white / fabric, plastic, white  
Deckenleuchte; Stahl, weiss / Textil, Kunststoff, weiss  
plafonnier; acier, blanc / tissu, plastique, blanc

H 120, Ø 570

LED

40W

tunable  
WHITE

4000lm



remote

### 97782 ROMAO 1

ceiling light; steel, white / fabric, plastic, white  
Deckenleuchte; Stahl, weiss / Textil, Kunststoff, weiss  
plafonnier; acier, blanc / tissu, plastique, blanc

H 120, Ø 760

LED

60W

tunable  
WHITE

5800lm



remote

### 97779 ROMAO

ceiling light; steel, white / fabric linen, plastic, grey, white  
Deckenleuchte; Stahl, weiss / Textil Leinen, Kunststoff, grau,  
weiss  
plafonnier; acier, blanc / tissu de lin, plastique, gris, blanc

H 120, Ø 570

LED

40W

tunable  
WHITE

4000lm



remote



9 002759 977771



9 002759 977825



9 002759 977795







97784



incl./inkl./inclus



97783



incl./inkl./inclus



97778



incl./inkl./inclus



<b>TUNABLE WHITE</b> 3000 - 5000K	<b>DIMMABLE</b> 10 - 100%	<b>TIMER FUNCTION</b> off after 30sec.	<b>NIGHT LIGHT FUNCTION</b>	<u>97777</u>	<u>97782</u>
				<u>97778</u>	<u>97783</u>
				<u>97779</u>	<u>97784</u>

see page / siehe Seite / voir la page 416

### 97784 ROMAO

ceiling light; steel, white / fabric linen, plastic, grey, white  
Deckenleuchte; Stahl, weiss / Textil Leinen, Kunststoff, grau, weiss  
plafonnier; acier, blanc / tissu de lin, plastique, gris, blanc

H 120, Ø 760



### 97778 ROMAO 3

ceiling light; steel, white / fabric, plastic, taupe, white  
Deckenleuchte; Stahl, weiss / Textil, Kunststoff, taupe, weiss  
plafonnier; acier, blanc / tissu, plastique, taupe, blanc

H 120, Ø 570



### 97783 ROMAO 3

ceiling light; steel, white / fabric, plastic, taupe, white  
Deckenleuchte; Stahl, weiss / Textil, Kunststoff, taupe, weiss  
plafonnier; acier, blanc / tissu, plastique, taupe, blanc

H 120, Ø 760



9 002759 977849



9 002759 977788



9 002759 977832





### 97611 PASTERI

ceiling light; steel, white / fabric, white  
Deckenleuchte; Stahl, weiss / Textil, weiss  
plafonnier; acier, blanc / tissu, blanc

H 150, Ø 570



### 97615 PASTERI

ceiling light; steel, white / fabric, white  
Deckenleuchte; Stahl, weiss / Textil, weiss  
plafonnier; acier, blanc / tissu, blanc

H 150, Ø 760



### 97619 PASTERI

ceiling light; steel, white / fabric, white  
Deckenleuchte; Stahl, weiss / Textil, weiss  
plafonnier; acier, blanc / tissu, blanc

H 170, Ø 980





### 97613 PASTERI

ceiling light; steel, white / fabric, linen, grey, white  
Deckenleuchte; Stahl, weiss / Textil, Leinen, grau, weiss  
plafonnier; acier, blanc / tissu, lin, gris, blanc

H 150, Ø 570



### 97617 PASTERI

ceiling light; steel, white / fabric, linen, grey, white  
Deckenleuchte; Stahl, weiss / Textil, Leinen, grau, weiss  
plafonnier; acier, blanc / tissu, lin, gris, blanc

H 150, Ø 760



### 97622 PASTERI

ceiling light; steel, white / fabric, linen, grey, white  
Deckenleuchte; Stahl, weiss / Textil, Leinen, grau, weiss  
plafonnier; acier, blanc / tissu, lin, gris, blanc

H 170, Ø 980





97614



97618

### 97614 PASTERI

ceiling light; steel, white / fabric, linen, brown, white  
 Deckenleuchte; Stahl, weiss / Textil, Leinen, braun, weiss  
 plafonnier; acier, blanc / tissu, lin, marron, blanc

H 150, Ø 570



E27 3x 25W



9 002759 976149



### 97618 PASTERI

ceiling light; steel, white / fabric, linen, brown, white  
 Deckenleuchte; Stahl, weiss / Textil, Leinen, braun, weiss  
 plafonnier; acier, blanc / tissu, lin, marron, blanc

H 150, Ø 760



E27 5x 25W



9 002759 976187





### 97612 PASTERI

ceiling light; steel, white / fabric, taupe, white  
Deckenleuchte; Stahl, weiss / Textil, taupe, weiss  
plafonnier; acier, blanc / tissu, taupe, blanc

H 150, Ø 570



### 97616 PASTERI

ceiling light; steel, white / fabric, taupe, white  
Deckenleuchte; Stahl, weiss / Textil, taupe, weiss  
plafonnier; acier, blanc / tissu, taupe, blanc

H 150, Ø 760



### 97621 PASTERI

ceiling light; steel, white / fabric, taupe, white  
Deckenleuchte; Stahl, weiss / Textil, taupe, weiss  
plafonnier; acier, blanc / tissu, taupe, blanc

H 170, Ø 980







**99299**



99299 | 99302



**99089**



**99298**

### 99299 POSADERRA

ceiling light; steel, white / fabric, plastic, white  
Deckenleuchte; Stahl, weiss / Textil, Kunststoff, weiss  
plafonnier; acier, blanc / tissu, plastique, blanc

L 140, B 140, H 150



E27



1x 28W

### 99089 PASTERI SQUARE

ceiling light; steel, white / fabric, plastic, white  
Deckenleuchte; Stahl, weiss / Textil, Kunststoff, weiss  
plafonnier; acier, blanc / tissu, plastique, blanc

L 575, B 575, H 165



E27



5x 25W

### 99298 POSADERRA

ceiling light; steel, white / fabric, plastic, white  
Deckenleuchte; Stahl, weiss / Textil, Kunststoff, weiss  
plafonnier; acier, blanc / tissu, plastique, blanc

L 750, B 280, H 150



E27



3x 28W



9 002759 992996

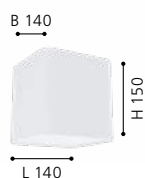

9 002759 990893



9 002759 992989

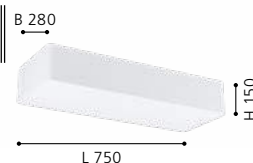



99302



99091



99301



99089 | 99298 | 99091 | 99301

### 99302 POSADERRA

ceiling light; steel, white / fabric, plastic, taupe, white  
Deckenleuchte; Stahl, weiss / Textil, Kunststoff, taupe, weiss  
plafonnier; acier, blanc / tissu, plastique, taupe, blanc

L 140, B 140, H 150



E27 1x 28W

### 99091 PASTERI SQUARE

ceiling light; steel, white / fabric, plastic, taupe, white  
Deckenleuchte; Stahl, weiss / Textil, Kunststoff, taupe, weiss  
plafonnier; acier, blanc / tissu, plastique, taupe, blanc

L 575, B 575, H 165



E27 5x 25W

### 99301 POSADERRA

ceiling light; steel, white / fabric, plastic, taupe, white  
Deckenleuchte; Stahl, weiss / Textil, Kunststoff, taupe, weiss  
plafonnier; acier, blanc / tissu, plastique, taupe, blanc

L 750, B 280, H 150



E27 3x 28W



9 002759 993023

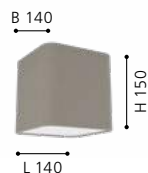

9 002759 990916



9 002759 993016

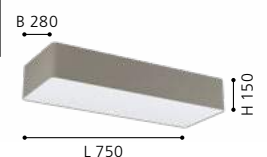

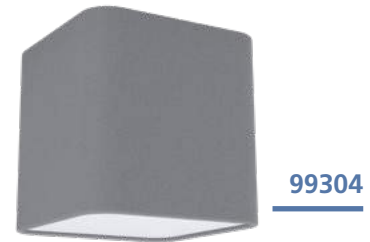

### 99304 POSADERRA

ceiling light; steel, white / fabric, plastic, grey, white  
Deckenleuchte; Stahl, weiss / Textil, Kunststoff, grau, weiss  
plafonnier; acier, blanc / tissu, plastique, gris, blanc

L 140, B 140, H 150



### 99092 PASTERI SQUARE

ceiling light; steel, white / fabric, plastic, grey, white  
Deckenleuchte; Stahl, weiss / Textil, Kunststoff, grau, weiss  
plafonnier; acier, blanc / tissu, plastique, gris, blanc

L 575, B 575, H 165



### 99303 POSADERRA

ceiling light; steel, white / fabric, plastic, grey, white  
Deckenleuchte; Stahl, weiss / Textil, Kunststoff, grau, weiss  
plafonnier; acier, blanc / tissu, plastique, gris, blanc

L 750, B 280, H 150

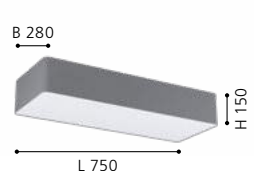
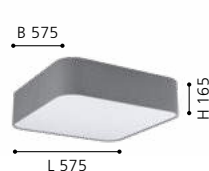
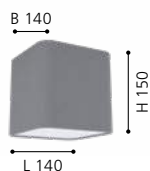



99303





**31581**



**31585**

### 31581 PASTERI

pendant light; steel, satin nickel / fabric, taupe  
 Hängeleuchte; Stahl, nickel-matt / Textil, taupe  
 luminaire en suspension; acier, nickel mat / tissu, taupe

L 750, B 220, H 1100

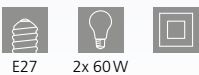

E27 2x 60W



9 002759 315818

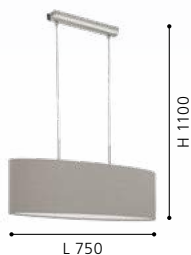

### 31585 PASTERI

pendant light; steel, satin nickel / fabric, taupe  
 Hängeleuchte; Stahl, nickel-matt / Textil, taupe  
 luminaire en suspension; acier, nickel mat / tissu, taupe

L 1000, B 280, H 1100

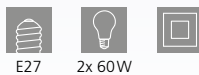

E27 2x 60W



9 002759 315856

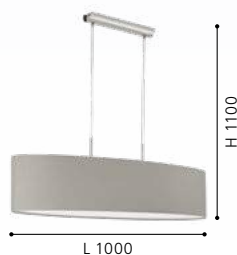

### 31572 PASTERI

pendant light; steel, satin nickel / fabric, taupe  
 Hängeleuchte; Stahl, nickel-matt / Textil, taupe  
 luminaire en suspension; acier, nickel mat / tissu, taupe

H 1100, Ø 380



E27 1x 60W



9 002759 315726







31572



31576

### 31576 PASTERI

pendant light; steel, satin nickel / fabric, taupe  
Hängeleuchte; Stahl, nickel-matt / Textil, taupe  
luminaire en suspension; acier, nickel mat / tissu, taupe

H 1100, Ø 530



E27



1x 60W



9 002759 315764



H 1100

Ø 530





94919



94919



94925



96478



### 94919 PASTERI

ceiling light; steel, satin nickel / fabric, glass, taupe  
Deckenleuchte; Stahl, nickel-matt / Textil, Glas, taupe  
plafonnier; acier, nickel mat / tissu, verre, taupe

H 195, Ø 475



E27 3x 25W



9 002759 949198



### 94925 PASTERI

wall light; steel, satin nickel / fabric, taupe  
Wandleuchte; Stahl, nickel-matt / Textil, taupe  
applique; acier, nickel mat / tissu, taupe

L 145, H 305, A 195



E27 1x 60W



9 002759 949259



### 96478 PASTERI

wall light; steel, satin nickel / fabric, taupe  
Wandleuchte; Stahl, nickel-matt / Textil, taupe  
applique; acier, nickel mat / tissu, taupe

L 150, H 380, A 195



E27 1x 40W 1x 3,5W 1x 380lm



9 002759 964788

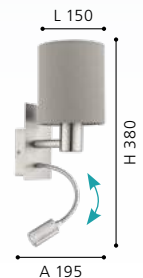



**95122**



**95122**

These luminaires can be switched on and off by touching the specially designed "Touch Me" part of the fixture.

Diese Leuchten können ein- und ausgeschaltet werden, indem man sie an den dafür vorgesehenen "Touch Me" Bereichen berührt.

Ces luminaires peuvent être éteints et allumés simplement en touchant la partie spécialement conçue pour "Touch Me" du luminaire.



**31595**



**95167**

### 95122 PASTERI

table light; steel, satin nickel / fabric, taupe  
Tischleuchte; Stahl, nickel-matt / Textil, taupe  
luminaire de table; acier, nickel mat / tissu, taupe

H 255, Ø 120



### 31595 PASTERI

table light; steel, satin nickel / fabric, taupe  
Tischleuchte; Stahl, nickel-matt / Textil, taupe  
luminaire de table; acier, nickel mat / tissu, taupe

H 400, Ø 180

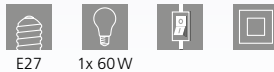

### 95167 PASTERI

floor light; steel, satin nickel / fabric, taupe  
Stehleuchte; Stahl, nickel-matt / Textil, taupe  
lampadaire; acier, nickel mat / tissu, taupe

H 1575, Ø 280, Base: Ø 230

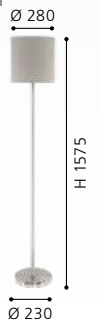



31582



31592

LED



31586

### 31582 PASTERI

pendant light; steel, satin nickel / fabric, grey  
Hängeleuchte; Stahl, nickel-matt / Textil, grau  
luminaire en suspension; acier, nickel mat / tissu, gris

L 750, B 220, H 1100

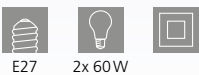

E27 2x 60W



9 002759 315825

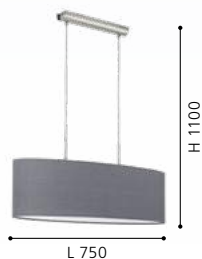

### 31586 PASTERI

pendant light; steel, satin nickel / fabric, grey  
Hängeleuchte; Stahl, nickel-matt / Textil, grau  
luminaire en suspension; acier, nickel mat / tissu, gris

L 1000, B 280, H 1100

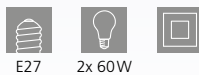

E27 2x 60W



9 002759 315863



### 31592 PASTERI

ceiling light; plastic, steel, white / fabric, grey  
Deckenleuchte; Kunststoff, Stahl, weiss / Textil, grau  
plafonnier; plastique, acier, blanc / tissu, gris

H 90, Ø 320



LED warm WHITE 11W 950lm



9 002759 315924





### 94921 PASTERI

ceiling light; steel, satin nickel / fabric, glass, grey  
Deckenleuchte; Stahl, nickel-matt / Textil, Glas, grau  
plafonnier; acier, nickel mat / tissu, verre, gris

H 195, Ø 475



### 31577 PASTERI

pendant light; steel, satin nickel / fabric, grey  
Hängeleuchte; Stahl, nickel-matt / Textil, grau  
luminaire en suspension; acier, nickel mat / tissu, gris

H 1100, Ø 530



### 31573 PASTERI

pendant light; steel, satin nickel / fabric, grey  
Hängeleuchte; Stahl, nickel-matt / Textil, grau  
luminaire en suspension; acier, nickel mat / tissu, gris

H 1100, Ø 380

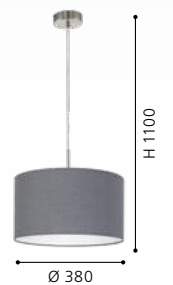





**94926**



**96479**

**LED**

**94926 PASTERI**

wall light; steel, satin nickel / fabric, grey  
 Wandleuchte; Stahl, nickel-matt / Textil, grau  
 applique; acier, nickel mat / tissu, gris

L 145, H 305, A 195



E27 1x 60W



**96479 PASTERI**

wall light; steel, satin nickel / fabric, grey  
 Wandleuchte; Stahl, nickel-matt / Textil, grau  
 applique; acier, nickel mat / tissu, gris

L 150, H 380, A 195



E27 1x 40W 1x 3,5W 1x 380lm

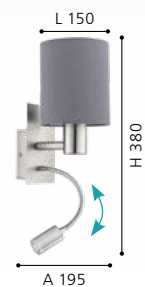



95119



95119

These luminaires can be switched on and off by touching the specially designed "Touch Me" part of the fixture.

Diese Leuchten können ein- und ausgeschaltet werden, indem man sie an den dafür vorgesehenen "Touch Me" Bereichen berührt.

Ces luminaires peuvent être éteints et allumés simplement en touchant la partie spécialement conçue pour "Touch Me" du luminaire.



31596



95166

### 95119 PASTERI

table light; steel, satin nickel / fabric, grey  
Tischleuchte; Stahl, nickel-matt / Textil, grau  
luminaire de table; acier, nickel mat / tissu, gris

H 255, Ø 120



E27 1x 40W



9 002759 951191



### 31596 PASTERI

table light; steel, satin nickel / fabric, grey  
Tischleuchte; Stahl, nickel-matt / Textil, grau  
luminaire de table; acier, nickel mat / tissu, gris

H 400, Ø 180

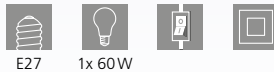

E27 1x 60W



9 002759 315962



### 95166 PASTERI

floor light; steel, satin nickel / fabric, grey  
Stehleuchte; Stahl, nickel-matt / Textil, grau  
lampadaire; acier, nickel mat / tissu, gris

H 1575, Ø 280, Base: Ø 230



E27 1x 60W



9 002759 951665

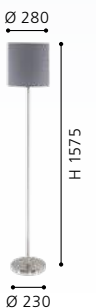



31583

### 31583 PASTERI

pendant light; steel, satin nickel / fabric, anthracite-brown  
Hängeleuchte; Stahl, nickel-matt / Textil, anthrazit-braun  
luminaire en suspension; acier, nickel mat / tissu, anthracite  
marron

L 750, B 220, H 1100



E27



2x 60W



9 002759 315832





### 31578 PASTERI

pendant light; steel, satin nickel / fabric, anthracite-brown  
Hängeleuchte; Stahl, nickel-matt / Textil, anthrazit-braun  
luminaire en suspension; acier, nickel mat / tissu, anthracite marron

H 1100, Ø 530



### 31574 PASTERI

pendant light; steel, satin nickel / fabric, anthracite-brown  
Hängeleuchte; Stahl, nickel-matt / Textil, anthrazit-braun  
luminaire en suspension; acier, nickel mat / tissu, anthracite marron

H 1100, Ø 380



### 96481 PASTERI

wall light; steel, satin nickel / fabric, anthracite-brown  
Wandleuchte; Stahl, nickel-matt / Textil, anthrazit-braun  
applique; acier, nickel mat / tissu, anthracite marron

L 150, H 380, A 195

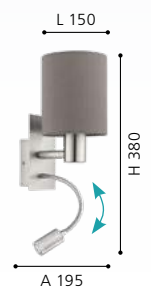



**31579**



**31575**

DESIGN  
HIGHLIGHT  
DETAIL



### 31579 PASTERI

pendant light; steel, satin nickel / fabric, white  
Hängeleuchte; Stahl, nickel-matt / Textil, weiss  
luminaire en suspension; acier, nickel mat / tissu, blanc

L 750, B 220, H 1100

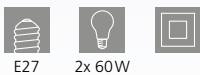

### 31575 PASTERI

pendant light; steel, satin nickel / fabric, white  
Hängeleuchte; Stahl, nickel-matt / Textil, weiss  
luminaire en suspension; acier, nickel mat / tissu, blanc

H 1100, Ø 530







31571



94918



31588

LED



EGLO  
RECOMMENDS  
11596

94918

### 31571 PASTERI

pendant light; steel, satin nickel / fabric, white  
Hängeleuchte; Stahl, nickel-matt / Textil, weiss  
luminaire en suspension; acier, nickel mat / tissu, blanc

H 1100, Ø 380



9 002759 315719



### 31588 PASTERI

ceiling light; plastic, steel, white / fabric, white  
Deckenleuchte; Kunststoff, Stahl, weiss / Textil, weiss  
plafonnier; plastique, acier, blanc / tissu, blanc

H 90, Ø 320



9 002759 315887



### 94918 PASTERI

ceiling light; steel, satin nickel / fabric, glass, white  
Deckenleuchte; Stahl, nickel-matt / Textil, Glas, weiss  
plafonnier; acier, nickel mat / tissu, verre, blanc

H 195, Ø 475



9 002759 949181





94924



95118



96477

LED

95118

These luminaires can be switched on and off by touching the specially designed "Touch Me" part of the fixture.

Diese Leuchten können ein- und ausgeschaltet werden, indem man sie an den dafür vorgesehenen "Touch Me" Bereichen berührt.

Ces luminaires peuvent être éteints et allumés simplement en touchant la partie spécialement conçue pour "Touch Me" du luminaire.



### 96477 PASTERI

wall light; steel, satin nickel / fabric, white  
Wandleuchte; Stahl, nickel-matt / Textil, weiss  
applique; acier, nickel mat / tissu, blanc

L 150, H 380, A 195

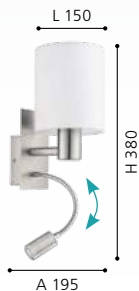
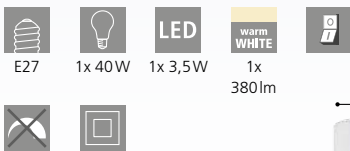

### 94924 PASTERI

wall light; steel, satin nickel / fabric, white  
Wandleuchte; Stahl, nickel-matt / Textil, weiss  
applique; acier, nickel mat / tissu, blanc

L 145, H 305, A 195

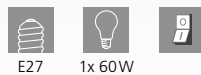

### 95118 PASTERI

table light; steel, satin nickel / fabric, white  
Tischleuchte; Stahl, nickel-matt / Textil, weiss  
luminaire de table; acier, nickel mat / tissu, blanc

H 255, Ø 120

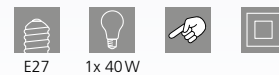



**31594**



**95164**

**31594 PASTERI**

table light; steel, satin nickel / fabric, white  
Tischleuchte; Stahl, nickel-matt / Textil, weiss  
luminaire de table; acier, nickel mat / tissu, blanc

H 400, Ø 180

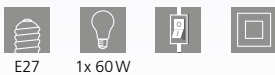

E27 1x 60W



**95164 PASTERI**

floor light; steel, satin nickel / fabric, white  
Stehleuchte; Stahl, nickel-matt / Textil, weiss  
lampadaire; acier, nickel mat / tissu, blanc

H 1575, Ø 280, Base: Ø 230



E27 1x 60W

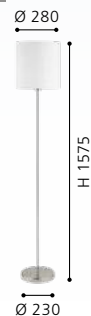



95044



95045

DESIGN  
HIGHLIGHT  
DETAIL



### 95044 PASTERI

pendant light; steel, satin nickel / fabric, white, copper  
Hängeleuchte; Stahl, nickel-matt / Textil, weiss, kupfer  
luminaire en suspension; acier, nickel mat / tissu, blanc, cuivre

H 1100, Ø 380



9 002759 950446



### 95045 PASTERI

pendant light; steel, satin nickel / fabric, white, copper  
Hängeleuchte; Stahl, nickel-matt / Textil, weiss, kupfer  
luminaire en suspension; acier, nickel mat / tissu, blanc, cuivre

H 1100, Ø 530



9 002759 950453





### 96483 PASTERI

wall light; steel, satin nickel / fabric, black, copper  
 Wandleuchte; Stahl, nickel-matt / Textil, schwarz, kupfer  
 applique; acier, nickel mat / tissu, noir, cuivre

L 150, H 380, A 195



### 96484 PASTERI

wall light; steel, satin nickel / fabric, white, copper  
 Wandleuchte; Stahl, nickel-matt / Textil, weiss, kupfer  
 applique; acier, nickel mat / tissu, blanc, cuivre

L 150, H 380, A 195







**97643**

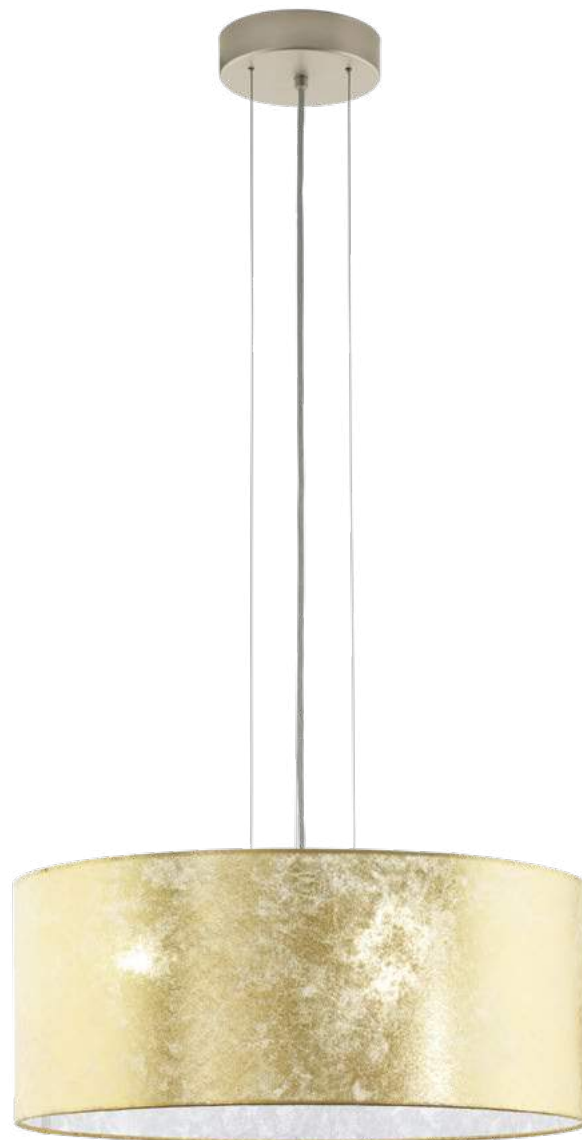

**97644**

**97643 VISERBELLA**

pendant light; steel, champagne / fabric, gold  
 Hängeleuchte; Stahl, champagner / Textil, gold  
 luminaire en suspension; acier, champagne / tissu, or

H 1100, Ø 380



9 002759 976439



**97644 VISERBELLA**

pendant light; steel, champagne / fabric, gold  
 Hängeleuchte; Stahl, champagner / Textil, gold  
 luminaire en suspension; acier, champagne / tissu, or

H 1100, Ø 530



9 002759 976446



**97641 VISERBELLA**

ceiling light; steel, champagne / fabric, gold  
 Deckenleuchte; Stahl, champagner / Textil, gold  
 plafonnier; acier, champagne / tissu, or

H 110, Ø 380



9 002759 976415





97641



97642



97641 | 97642



### 97642 VISERBELLA

ceiling light; steel, champagne / fabric, gold  
Deckenleuchte; Stahl, champagner / Textil, gold  
plafonnier; acier, champagne / tissu, or

H 195, Ø 470





DESIGN  
HIGHLIGHT  
DETAIL



97645



97647

### 97645 VISERBELLA

wall light; steel, champagne / fabric, gold  
Wandleuchte; Stahl, champagner / Textil, gold  
applique; acier, champagne / tissu, or

L 145, H 305, A 195

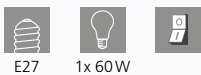

E27 1x 60W



9 002759 976453



### 97647 VISERBELLA

floor light; steel, champagne / fabric, gold  
Stehleuchte; Stahl, champagner / Textil, gold  
lampadaire; acier, champagne / tissu, or

H 1585, Ø 280, Base: Ø 230

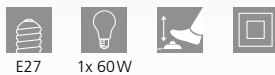

E27 1x 60W



9 002759 976477

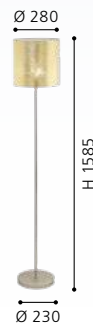

### 97646 VISERBELLA

table light; steel, champagne / fabric, gold  
Tischleuchte; Stahl, champagner / Textil, gold  
luminaire de table; acier, champagne / tissu, or

H 400, Ø 180, Base: Ø 150



E27 1x 60W



9 002759 976460

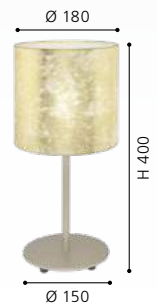



97646





DESIGN  
HIGHLIGHT  
DETAIL



### 99273 ESTEPERRA

pendant light; steel, black / fabric, black, gold  
Hängeleuchte; Stahl, schwarz / Textil, schwarz, gold  
luminaire en suspension; acier, noir / tissu, noir, or

H 1100, Ø 380



### 99272 ESTEPERRA

ceiling light; steel, black / fabric, black, gold  
Deckenleuchte; Stahl, schwarz / Textil, schwarz, gold  
plafonnier; acier, noir / tissu, noir, or

H 240, Ø 475



### 99274 ESTEPERRA

pendant light; steel, black / fabric, black, gold  
Hängeleuchte; Stahl, schwarz / Textil, schwarz, gold  
luminaire en suspension; acier, noir / tissu, noir, or

H 1100, Ø 530





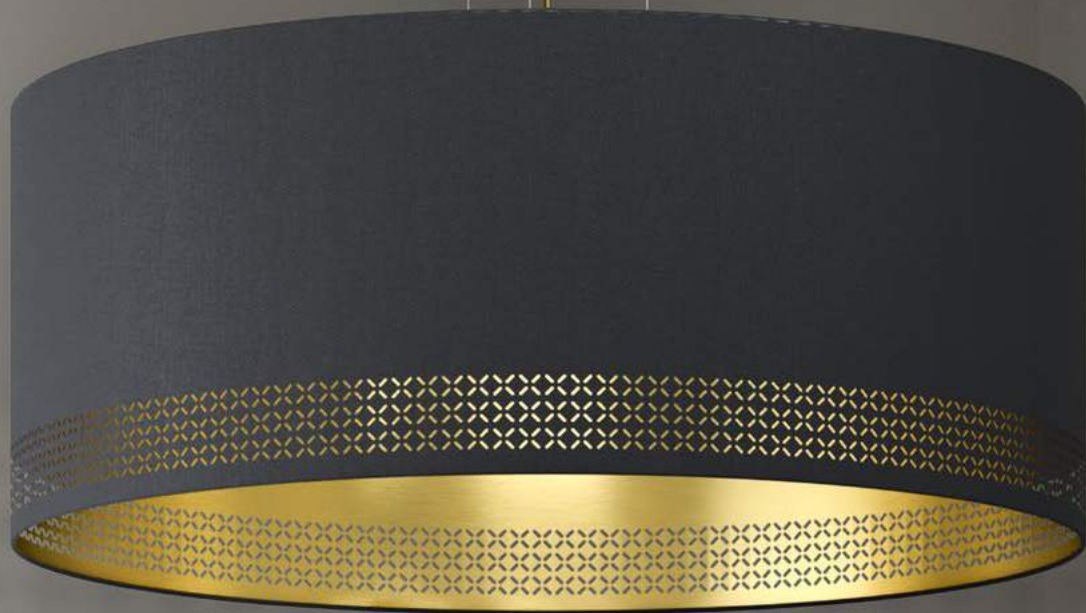

99274





**99279**

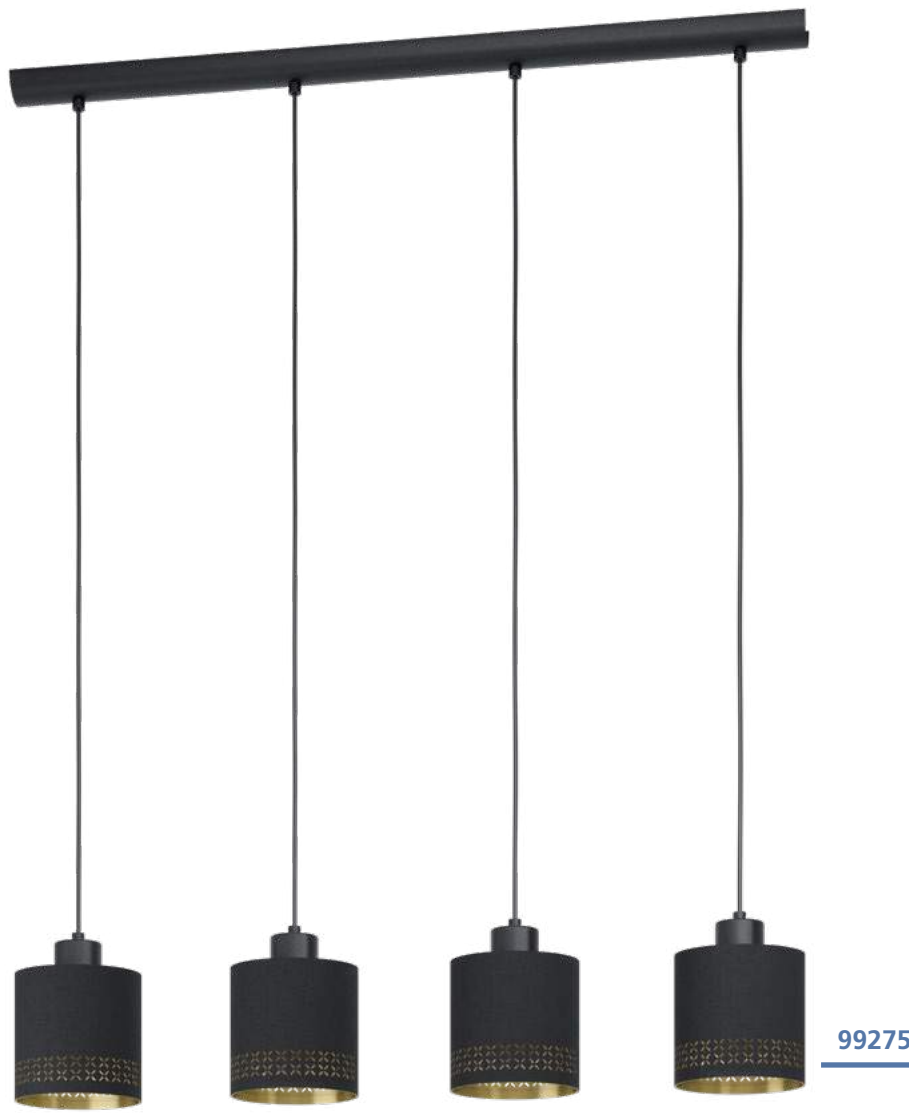

DESIGN  
HIGHLIGHT  
DETAIL



### 99279 ESTEPERRA

floor light; steel, black / fabric, black, gold  
Stehleuchte; Stahl, schwarz / Textil, schwarz, gold  
lampadaire; acier, noir / tissu, noir, or

H 1405, Ø 380, Base: Ø 645

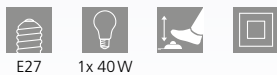

E27 1x 40W



9 002759 992798



### 99275 ESTEPERRA

pendant light; steel, black / fabric, black, gold  
Hängeleuchte; Stahl, schwarz / Textil, schwarz, gold  
luminaire en suspension; acier, noir / tissu, noir, or

L 940, B 160, H 1100



E27 4x 28W



9 002759 992750

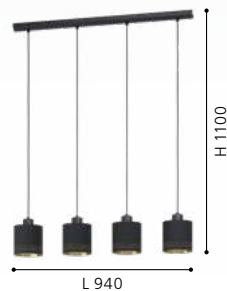



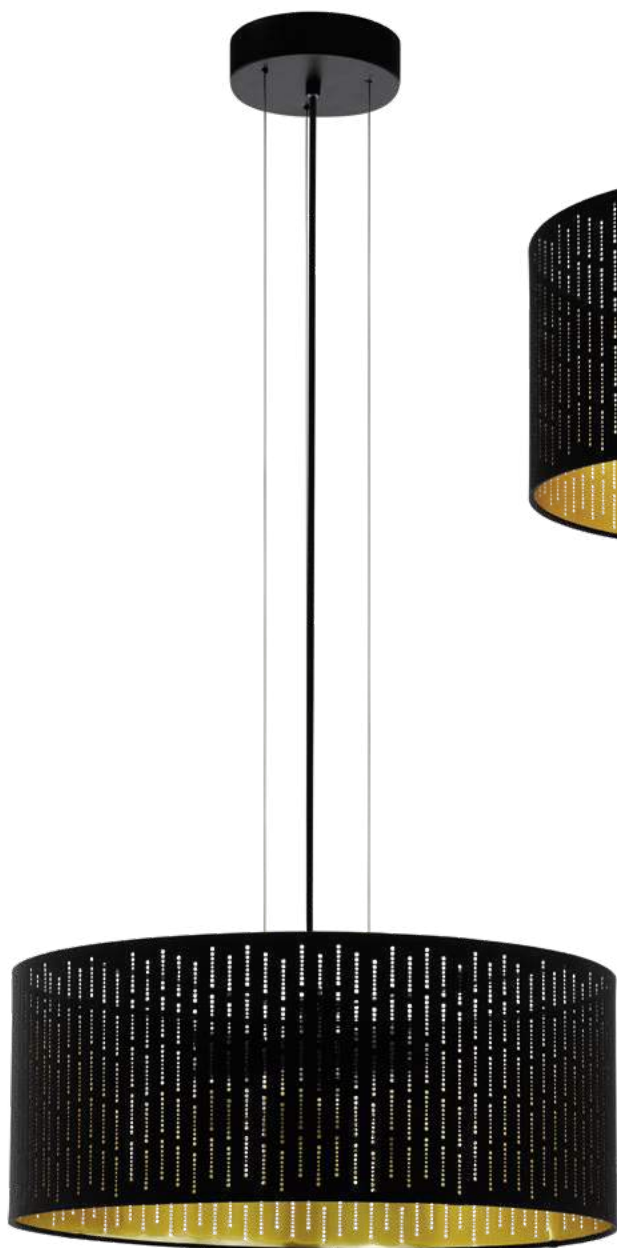

98313

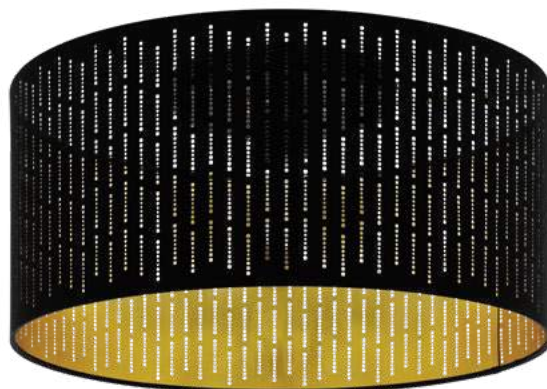

98311



98314

### 98313 VARILLAS

pendant light; steel, black / fabric with cut-outs, black, gold  
Hängeleuchte; Stahl, schwarz / Textil mit Ausstanzungen, schwarz, gold

luminaire en suspension; acier, noir / tissu avec découpes, noir, or

H 1100, Ø 530



E27

3x 40W



9 002759 983130



### 98311 VARILLAS

ceiling light; steel, black / fabric with cut-outs, black, gold  
Deckenleuchte; Stahl, schwarz / Textil mit Ausstanzungen, schwarz, gold

plafonnier; acier, noir / tissu avec découpes, noir, or

H 240, Ø 475



E27

1x 40W



9 002759 983116

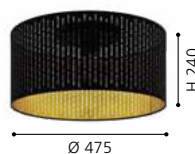

### 98314 VARILLAS

table light; steel, black / fabric with cut-outs, black, gold  
Tischleuchte; Stahl, schwarz / Textil mit Ausstanzungen, schwarz, gold

luminaire de table; acier, noir / tissu avec découpes, noir, or

H 255, Ø 120



E27

1x 40W



9 002759 983147

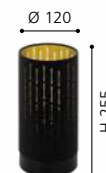

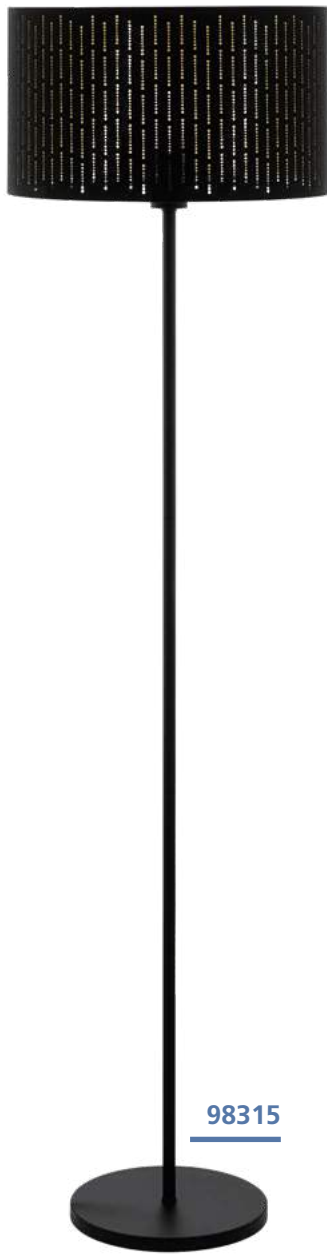

98315

DESIGN  
HIGHLIGHT  
DETAIL



### 98315 VARILLAS

floor light; steel, black / fabric with cut-outs, black, gold  
Stehleuchte; Stahl, schwarz / Textil mit Ausstanzungen, schwarz,  
gold  
lampadaire; acier, noir / tissu avec découpes, noir, or

H 1510, Ø 380, Base: Ø 250



E27



1x 40W



9 002759 983154

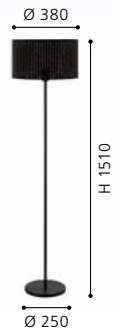





99613

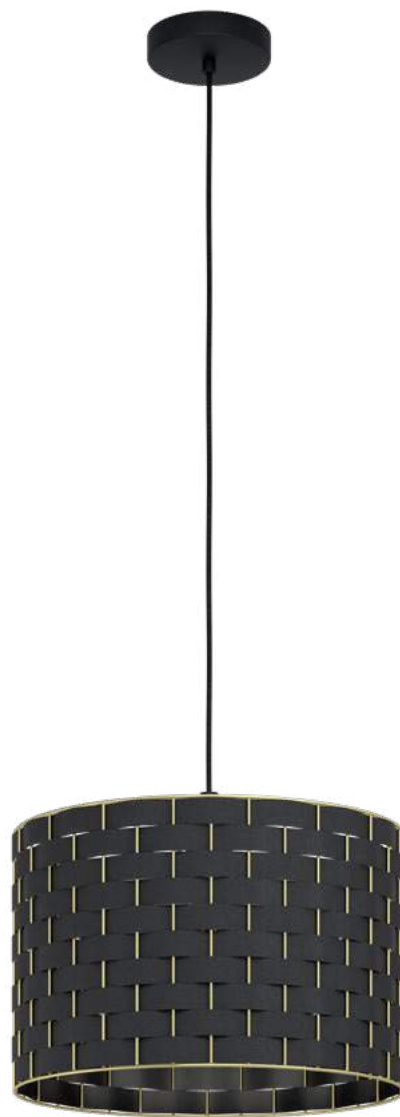

99524

### 99613 MARASALES

pendant light; steel, black / fabric, black, brass  
 Hängeleuchte; Stahl, schwarz / Textil, schwarz, messing  
 luminaire en suspension; acier, noir / tissu, noir, laiton

L 780, B 220, H 1100

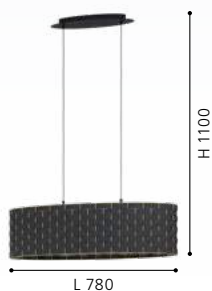

### 99524 MARASALES

pendant light; steel, black / fabric, black, brass  
 Hängeleuchte; Stahl, schwarz / Textil, schwarz, messing  
 luminaire en suspension; acier, noir / tissu, noir, laiton

H 1100, Ø 380



### 99525 MARASALES

pendant light; steel, black / fabric, black, brass  
 Hängeleuchte; Stahl, schwarz / Textil, schwarz, messing  
 luminaire en suspension; acier, noir / tissu, noir, laiton

H 1100, Ø 550

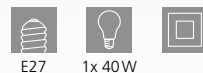

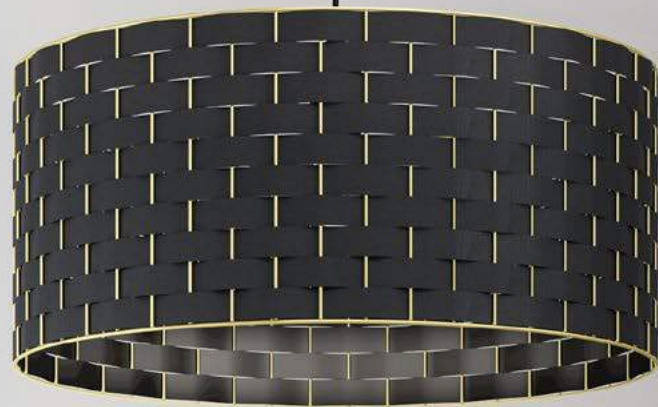

99525





99523



99526

### 99523 MARASALES

ceiling light; steel, black / fabric, black, brass  
Deckenleuchte; Stahl, schwarz / Textil, schwarz, messing  
plafonnier; acier, noir / tissu, noir, laiton

H 250, Ø 480

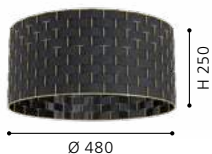

### 99526 MARASALES

table light; steel, black / fabric, black, brass  
Tischleuchte; Stahl, schwarz / Textil, schwarz, messing  
luminaire de table; acier, noir / tissu, noir, laiton

H 570, Ø 280



### 99527 MARASALES

floor light; steel, black / fabric, black, brass  
Stehleuchte; Stahl, schwarz / Textil, schwarz, messing  
lampadaire; acier, noir / tissu, noir, laiton

H 1490, Ø 450, Base: Ø 745







99527





31601



99543

LED



31606

### 31601 MASERLO

pendant light; steel, satin nickel / fabric, grey, silver  
 Hängeleuchte; Stahl, nickel-matt / Textil, grau, silber  
 luminaire en suspension; acier, nickel mat / tissu, gris, argent

H 1100, Ø 380

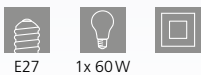

9 002759 316013



### 31606 MASERLO

pendant light; steel, satin nickel / fabric, grey, silver  
 Hängeleuchte; Stahl, nickel-matt / Textil, grau, silber  
 luminaire en suspension; acier, nickel mat / tissu, gris, argent

H 1100, Ø 530



9 002759 316068



### 99543 MASERLO 2

ceiling light; plastic, steel, white / fabric, grey, silver  
 Deckenleuchte; Kunststoff, Stahl, weiss / Textil, grau, silber  
 plafonnier; plastique, acier, blanc / tissu, gris, argent

H 90, Ø 380



9 002759 995430







**31628**

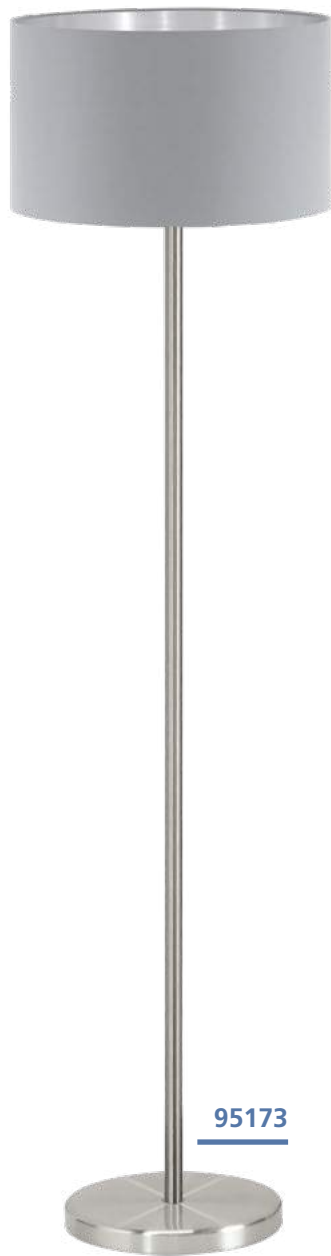

**95173**



### 31628 MASERLO

table light; steel, satin nickel / fabric, grey, silver  
Tischleuchte; Stahl, nickel-matt / Textil, grau, silber  
luminaire de table; acier, nickel mat / tissu, gris, argent

H 420, Ø 230

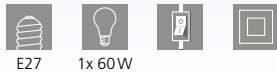

E27 1x 60W



### 95173 MASERLO

floor light; steel, satin nickel / fabric, grey, silver  
Stehleuchte; Stahl, nickel-matt / Textil, grau, silber  
lampadaire; acier, nickel mat / tissu, gris, argent

H 1510, Ø 380, Base: Ø 250



E27 1x 60W

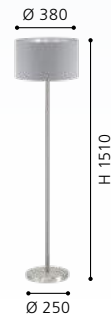



99044





99042



99043



MASERLO 1

### 99044 MASERLO 1

pendant light; steel, black / fabric, black  
 Hängeleuchte; Stahl, schwarz / Textil, schwarz  
 luminaire en suspension; acier, noir / tissu, noir

L 780, B 220, H 1100



### 99042 MASERLO 1

pendant light; steel, black / fabric, black  
 Hängeleuchte; Stahl, schwarz / Textil, schwarz  
 luminaire en suspension; acier, noir / tissu, noir

H 1100, Ø 380

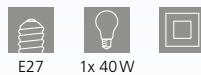

### 99043 MASERLO 1

pendant light; steel, black / fabric, black  
 Hängeleuchte; Stahl, schwarz / Textil, schwarz  
 luminaire en suspension; acier, noir / tissu, noir

H 1100, Ø 530

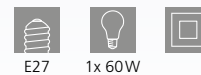



DESIGN  
HIGHLIGHT  
DETAIL



99041



MASERLO 1



99045

### 99041 MASERLO 1

ceiling light; steel, black / fabric, black  
Deckenleuchte; Stahl, schwarz / Textil, schwarz  
plafonnier; acier, noir / tissu, noir

H 240, Ø 400



E27 1x 40W



### 99045 MASERLO 1

table light; steel, black / fabric, black  
Tischleuchte; Stahl, schwarz / Textil, schwarz  
luminaire de table; acier, noir / tissu, noir

H 415, Ø 230, Base: Ø 145



E27 1x 40W



### 99046 MASERLO 1

floor light; steel, black / fabric, black  
Stehleuchte; Stahl, schwarz / Textil, schwarz  
lampadaire; acier, noir / tissu, noir

H 1515, Ø 380, Base: Ø 250



E27 1x 40W

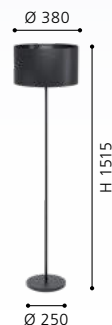



99046





31611



31616

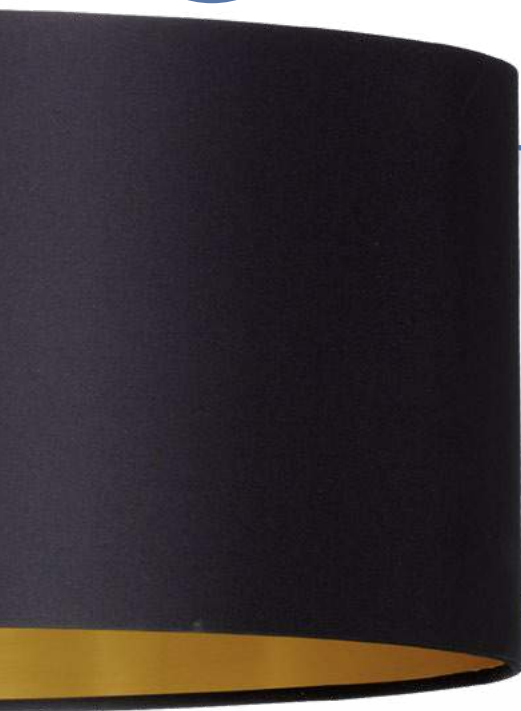

### 31611 MASERLO

pendant light; steel, satin nickel / fabric, black, gold  
Hängeleuchte; Stahl, nickel-matt / Textil, schwarz, gold  
luminaire en suspension; acier, nickel mat / tissu, noir, or

L 780, B 220, H 1100



E27 2x 60W

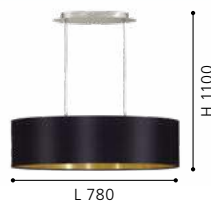

### 31616 MASERLO

pendant light; steel, satin nickel / fabric, black, gold  
Hängeleuchte; Stahl, nickel-matt / Textil, schwarz, gold  
luminaire en suspension; acier, nickel mat / tissu, noir, or

L 1000, B 250, H 1100



E27 2x 60W

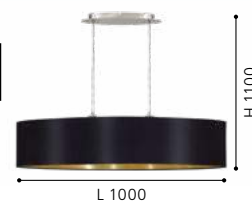



### 31599 MASERLO

pendant light; steel, satin nickel / fabric, black, gold  
 Hängeleuchte; Stahl, nickel-matt / Textil, schwarz, gold  
 luminaire en suspension; acier, nickel mat / tissu, noir, or

H 1100, Ø 380

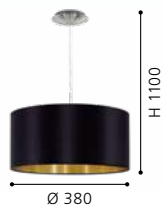

### 31605 MASERLO

pendant light; steel, satin nickel / fabric, black, gold  
 Hängeleuchte; Stahl, nickel-matt / Textil, schwarz, gold  
 luminaire en suspension; acier, nickel mat / tissu, noir, or

H 1100, Ø 530

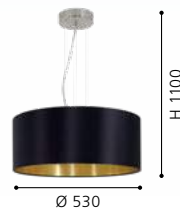



99539



31627

### 99539 MASERLO 2

ceiling light; plastic, steel, white / fabric, black, gold  
Deckenleuchte; Kunststoff, Stahl, weiss / Textil, schwarz, gold  
plafonnier; plastique, acier, blanc / tissu, noir, or

H 90, Ø 380



24W



2100lm



9 002759 995393

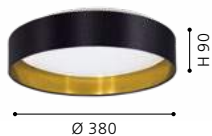

### 31627 MASERLO

table light; steel, satin nickel / fabric, black, gold  
Tischleuchte; Stahl, nickel-matt / Textil, schwarz, gold  
luminaire de table; acier, nickel mat / tissu, noir, or

H 420, Ø 230



E27



1x 60W



9 002759 316273



### 95169 MASERLO

floor light; steel, satin nickel / fabric, black, gold  
Stehleuchte; Stahl, nickel-matt / Textil, schwarz, gold  
lampadaire; acier, nickel mat / tissu, noir, or

H 1510, Ø 380, Base: Ø 250



E27



1x 60W



9 002759 951696

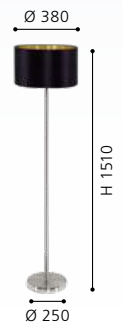



95169



### 31618 MASERLO

pendant light; steel, satin nickel / fabric, taupe, gold  
 Hängeleuchte; Stahl, nickel-matt / Textil, taupe, gold  
 luminaire en suspension; acier, nickel mat / tissu, taupe, or

L 1000, B 250, H 1100

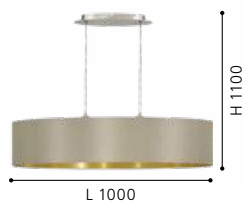
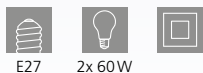

### 31602 MASERLO

pendant light; steel, satin nickel / fabric, taupe, gold  
 Hängeleuchte; Stahl, nickel-matt / Textil, taupe, gold  
 luminaire en suspension; acier, nickel mat / tissu, taupe, or

H 1100, Ø 380



### 31607 MASERLO

pendant light; steel, satin nickel / fabric, taupe, gold  
 Hängeleuchte; Stahl, nickel-matt / Textil, taupe, gold  
 luminaire en suspension; acier, nickel mat / tissu, taupe, or

H 1100, Ø 530

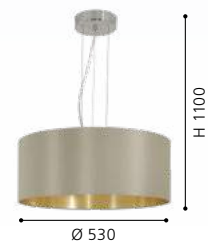





99541

LED



31613

### 99541 MASERLO 2

ceiling light; plastic, steel, white / fabric, taupe, gold  
Deckenleuchte; Kunststoff, Stahl, weiss / Textil, taupe, gold  
plafonnier; plastique, acier, blanc / tissu, taupe, or

H 90, Ø 380



24W 2100lm



9 002759 995416

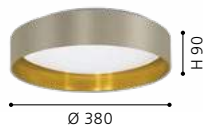

### 31613 MASERLO

pendant light; steel, satin nickel / fabric, taupe, gold  
Hängeleuchte; Stahl, nickel-matt / Textil, taupe, gold  
luminaire en suspension; acier, nickel mat / tissu, taupe, or

L 780, B 220, H 1100



E27 2x 60W



9 002759 316136

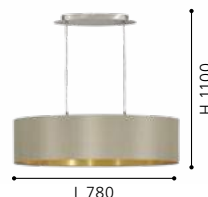

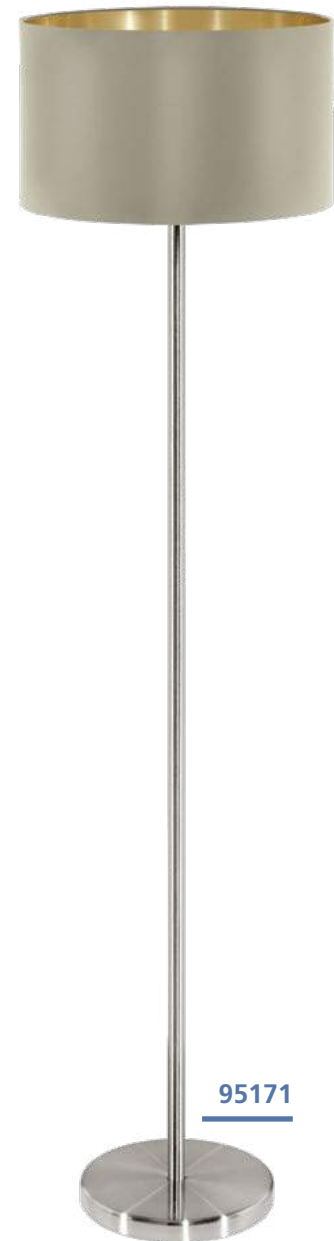

### 95055 MASERLO

wall light; steel, satin nickel / fabric, taupe, gold  
Wandleuchte; Stahl, nickel-matt / Textil, taupe, gold  
applique; acier, nickel mat / tissu, taupe, or

H 260, Ø 230, A 595

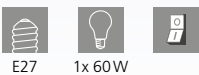

### 31629 MASERLO

table light; steel, satin nickel / fabric, taupe, gold  
Tischleuchte; Stahl, nickel-matt / Textil, taupe, gold  
luminaire de table; acier, nickel mat / tissu, taupe, or

H 420, Ø 230

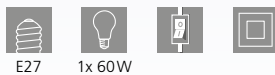

### 95171 MASERLO

floor light; steel, satin nickel / fabric, taupe, gold  
Stehleuchte; Stahl, nickel-matt / Textil, taupe, gold  
lampadaire; acier, nickel mat / tissu, taupe, or

H 1510, Ø 380, Base: Ø 250





### 31614 MASERLO

pendant light; steel, satin nickel / fabric, cappuccino, gold  
 Hängeleuchte; Stahl, nickel-matt / Textil, cappuccino, gold  
 luminaire en suspension; acier, nickel mat / tissu, cappucino, or

L 780, B 220, H 1100

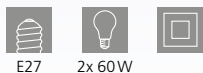

E27 2x 60W



9 002759 316143

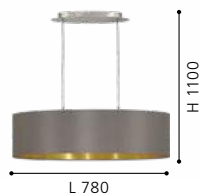

### 31619 MASERLO

pendant light; steel, satin nickel / fabric, cappuccino, gold  
 Hängeleuchte; Stahl, nickel-matt / Textil, cappuccino, gold  
 luminaire en suspension; acier, nickel mat / tissu, cappucino, or

L 1000, B 250, H 1100



E27 2x 60W



9 002759 316198

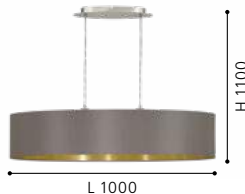

### 31603 MASERLO

pendant light; steel, satin nickel / fabric, cappuccino, gold  
 Hängeleuchte; Stahl, nickel-matt / Textil, cappuccino, gold  
 luminaire en suspension; acier, nickel mat / tissu, cappucino, or

H 1100, Ø 380

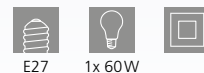

E27 1x 60W



9 002759 316037





99542

LED

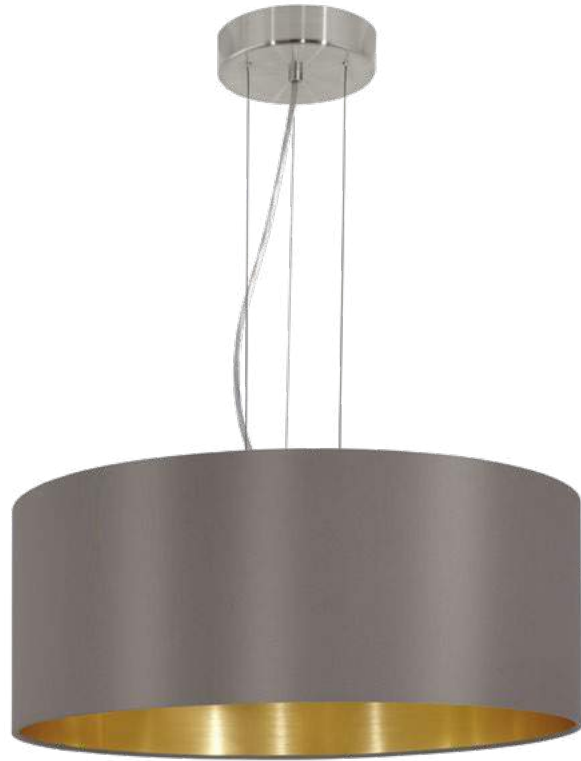

31608

### 99542 MASERLO 2

ceiling light; plastic, steel, white / fabric, cappuccino, gold  
Deckenleuchte; Kunststoff, Stahl, weiss / Textil, cappuccino, gold  
plafonnier; plastique, acier, blanc / tissu, cappuccino, or

H 90, Ø 380



24W



2100lm



9 002759 995423

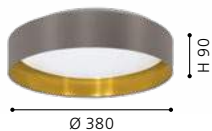

### 31608 MASERLO

pendant light; steel, satin nickel / fabric, cappuccino, gold  
Hängeleuchte; Stahl, nickel-matt / Textil, cappuccino, gold  
luminaire en suspension; acier, nickel mat / tissu, cappuccino, or

H 1100, Ø 530



E27



3x 60W



9 002759 316082



### 31631 MASERLO

table light; steel, satin nickel / fabric, cappuccino, gold  
Tischleuchte; Stahl, nickel-matt / Textil, cappuccino, gold  
luminaire de table; acier, nickel mat / tissu, cappuccino, or

H 420, Ø 230



E27



1x 60W



9 002759 316310

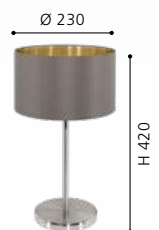



31631

### 95172 MASERLO

floor light; steel, satin nickel / fabric, cappuccino, gold  
Stehleuchte; Stahl, nickel-matt / Textil, cappuccino, gold  
lampadaire; acier, nickel mat / tissu, cappuccino, or

H 1510, Ø 380, Base: Ø 250



E27



1x 60W



Ø 380



9 002759 951726



H 1510

Ø 250



95172





97682

97683

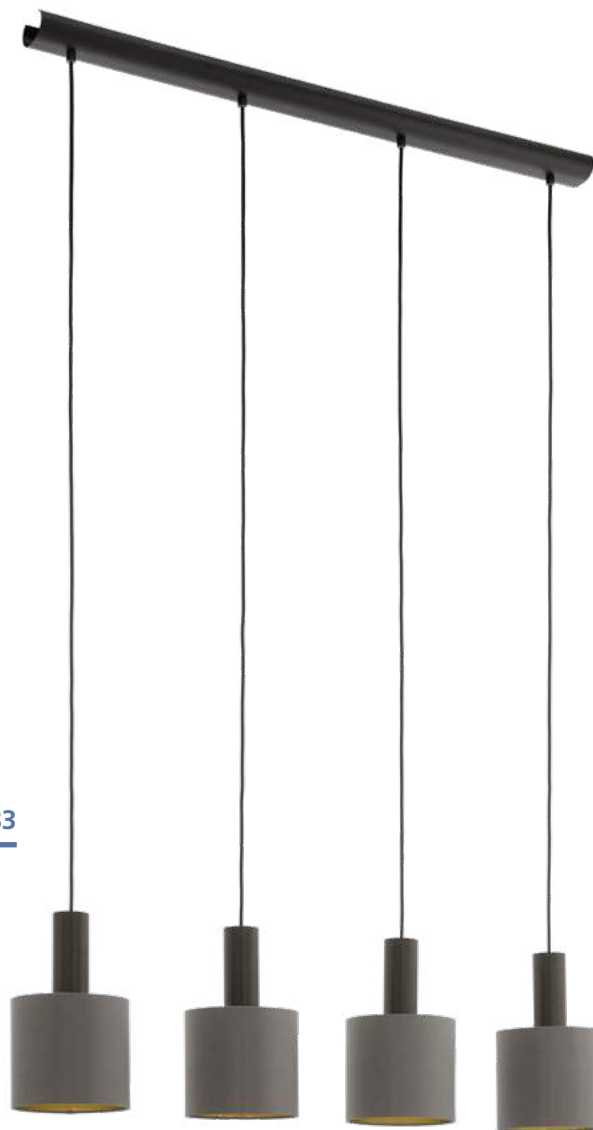

97685

### 97682 CONCESSA 1

pendant light; steel, dark brown / fabric, cappuccino, gold  
Hängeleuchte; Stahl, dunkelbraun / Textil, cappuccino, gold  
luminaire en suspension; acier, marron foncé / tissu, cappuccino, or

H 1500, Ø 380



9 002759 976828

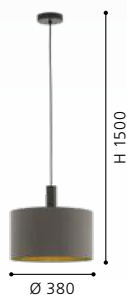

### 97683 CONCESSA 1

pendant light; steel, dark brown / fabric, cappuccino, gold  
Hängeleuchte; Stahl, dunkelbraun / Textil, cappuccino, gold  
luminaire en suspension; acier, marron foncé / tissu, cappuccino, or

H 1500, Ø 530

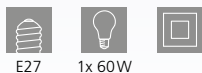

9 002759 976835



### 97685 CONCESSA 1

pendant light; steel, dark brown / fabric, cappuccino, gold  
Hängeleuchte; Stahl, dunkelbraun / Textil, cappuccino, gold  
luminaire en suspension; acier, marron foncé / tissu, cappuccino, or

L 940, B 160, H 1500

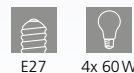

9 002759 976859





**97684**

### 97684 CONCESSA 1

pendant light; steel, dark brown / fabric, cappuccino, gold  
Hängeleuchte; Stahl, dunkelbraun / Textil, cappuccino, gold  
luminaire en suspension; acier, marron foncé / tissu, cappuccino,  
or

H 1500, Ø 420



E27



3x 60W



9 002759 976842



DESIGN  
HIGHLIGHT  
DETAIL



99445



99446



### 99445 ALBARIZA

pendant light; steel, wood, black, brown / fabric, cappuccino, gold

Hängeleuchte; Stahl, Holz, schwarz, braun / Textil, cappuccino, gold

luminaire en suspension; acier, bois, noir, marron / tissu, cappuccino, or

H 1100, Ø 160



E27

1x 40W



9 002759 994457

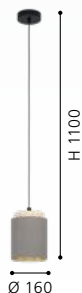

### 99446 ALBARIZA

pendant light; steel, wood, black, brown / fabric, cappuccino, gold

Hängeleuchte; Stahl, Holz, schwarz, braun / Textil, cappuccino, gold

luminaire en suspension; acier, bois, noir, marron / tissu, cappuccino, or

L 895, B 160, H 1100



E27

3x 40W



9 002759 994464



### 99447 ALBARIZA

pendant light; steel, wood, black, brown / fabric, cappuccino, gold

Hängeleuchte; Stahl, Holz, schwarz, braun / Textil, cappuccino, gold

luminaire en suspension; acier, bois, noir, marron / tissu, cappuccino, or

H 1500, Ø 700



E27

5x 40W



9 002759 994471





99447





### 99487 ALMEIDA 2

pendant light; steel, brushed brass / fabric, cappuccino, brass  
 Hängeleuchte; Stahl, messing-gebürstet / Textil, cappuccino, messing  
 luminaire en suspension; acier, laiton brossé / tissu, cappuccino, laiton

L 1200, B 155, H 1100



E14 5x 40W



9 002759 994877

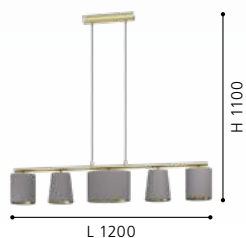

### 99486 ALMEIDA 2

ceiling light; steel, brushed brass / fabric, cappuccino, brass  
 Deckenleuchte; Stahl, messing-gebürstet / Textil, cappuccino, messing  
 plafonnier; acier, laiton brossé / tissu, cappuccino, laiton

L 810, B 155, H 280

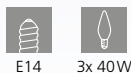

E14 3x 40W



9 002759 994860

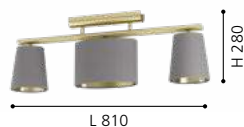

### 99612 ALMEIDA 2

floor light; steel, brushed brass / fabric, cappuccino, brass  
 Stehleuchte; Stahl, messing-gebürstet / Textil, cappuccino, messing  
 lampadaire; acier, laiton brossé / tissu, cappuccino, laiton

H 1670, Ø 320, Base: Ø 300



E27 3x 40W



9 002759 996123

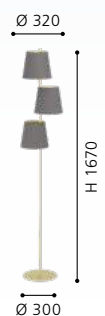





99612



99611

### 99611 ALMEIDA 2

table light; steel, brushed brass / fabric, cappuccino, brass  
 Tischleuchte; Stahl, messing-gebürstet / Textil, cappuccino, messing  
 luminaire de table; acier, laiton brossé / tissu, cappuccino, laiton

H 605, Ø 260, Base: Ø 200



E27 2x 40W



9 002759 996116

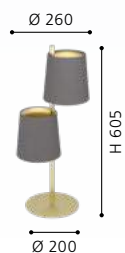



**98587**



**98588**



**98587 ALMEIDA 1**

pendant light; steel, black / fabric, grey, white  
 Hängeleuchte; Stahl, schwarz / Textil, grau, weiss  
 luminaire en suspension; acier, noir / tissu, gris, blanc

L 860, B 255, H 1100

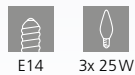

E14 3x 25W

**98588 ALMEIDA 1**

pendant light; steel, black / fabric, black, grey, white  
 Hängeleuchte; Stahl, schwarz / Textil, schwarz, grau, weiss  
 luminaire en suspension; acier, noir / tissu, noir, gris, blanc

L 1200, B 255, H 1100



E14 5x 25W



9 002759 985875



9 002759 985882





95193



95192



95194

### 95193 ALMEIDA

wall light; steel, black / fabric, white, anthracite  
Wandleuchte; Stahl, schwarz / Textil, weiss, anthrazit  
applique; acier, noir / tissu, blanc, anthracite

L 420, H 455, A 190



E14 2x 40W



9 002759 951931

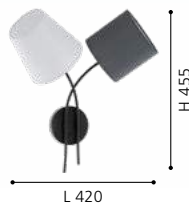

L 420

H 455

### 95192 ALMEIDA

ceiling light; steel, black / fabric, anthracite, white, brown  
Deckenleuchte; Stahl, schwarz / Textil, anthrazit, weiss, braun  
plafonnier; acier, noir / tissu, anthracite, blanc, marron

H 350, Ø 590



E14 3x 40W



9 002759 951924



Ø 590

H 350

### 95194 ALMEIDA

table light; steel, black / fabric, white, anthracite  
Tischleuchte; Stahl, schwarz / Textil, weiss, anthrazit  
luminaire de table; acier, noir / tissu, blanc, anthracite

L 380, B 185, H 475



E14 2x 40W



9 002759 951948

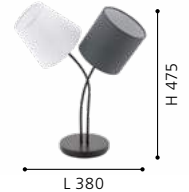

L 380

H 475



DESIGN  
HIGHLIGHT  
DETAIL



**92755**

**92755 TOMBOLO**

pendant light; steel, satin nickel / fabric with hoop-and-loop tape, creme, taupe, brown

Hängeleuchte; Stahl, nickel-matt / Textil mit Klettverschluss, creme, taupe, braun

luminaire en suspension; acier, nickel mat / tissu avec fermeture velcro, crème, taupe, marron

H 1100, Ø 545



E27 3x 60W



9 002759 927554



**94995 MARONDA**

floor light; steel, black / fabric, anthracite, white, brown

Stehleuchte; Stahl, schwarz / Textil, anthrazit, weiss, braun

lampadaire; acier, noir / tissu, anthracite, blanc, marron

L 275, B 35, H 1520

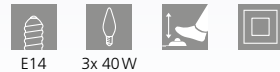

E14 3x 40W



9 002759 949952

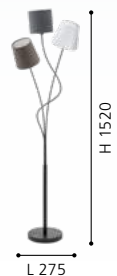



94995



# LIGHTING FAMILIES

WOOD LUMINAIRES

HOLZLEUCHTEN

LUMINAIRES À BOIS

## SIMPLE CLASSINESS -

The wood luminaires with their unusual designs are perfectly trendy and bring cosiness to every home. Our range of wood luminaires offers a great selection of various shapes, sizes and colours. It contains anything from suspended to table luminaires.

## SCHLICHTE ELEGANZ -

Die Holzleuchten mit ihrem außergewöhnlichen Design sind voll im Trend und sorgen für Gemütlichkeit in jedem Zuhause. Unser Sortiment an Holzleuchten bietet eine große Auswahl an verschiedenen Formen, Größen sowie Farben und reicht von der Hänge- bis hin zur Tischleuchte.



## ÉLÉGANCE SIMPLE -

Les luminaires en bois avec leur design extraordinaire sont très tendance et assurent un confort dans chaque maison. Notre gamme de luminaires en bois offre un grand choix de formes, de tailles et de couleurs différentes et s'étend des luminaires en suspension jusqu'aux luminaires de table.







# WOOD MATERIALS

## LAMELLA SHADES



wood, white  
Holz, weiss  
bois, blanc



wood, brown  
Holz, braun  
bois, marron



wood, maple  
Holz, ahorn  
bois, érable



wood, maple  
Holz, ahorn  
bois, érable

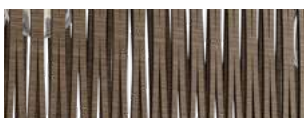

wood, brown  
Holz, braun  
bois, marron





95599



DESIGN  
HIGHLIGHT  
DETAIL

### 95599 STELLATO 1

pendant light; steel, satin nickel / wood, glass, maple, white  
Hängeleuchte; Stahl, nickel-matt / Holz, Glas, ahorn, weiss  
luminaire en suspension; acier, nickel mat / bois, verre, érable, blanc

H 1500, Ø 500



E27



1x 60W







### 95598 STELLATO 1

pendant light; steel, satin nickel / wood, glass, maple, white  
Hängeleuchte; Stahl, nickel-matt / Holz, Glas, ahorn, weiss  
luminaire en suspension; acier, nickel mat / bois, verre, érable, blanc

H 1300, Ø 400



### 95602 STELLATO 1

wall light; steel, white / wood, glass, maple, white  
Wandleuchte; Stahl, weiss / Holz, Glas, ahorn, weiss  
applique; acier, blanc / bois, verre, érable, blanc

L 285, H 250, A 140

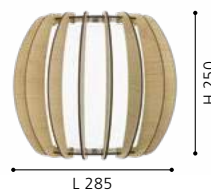

### 95597 STELLATO 1

ceiling light; steel, satin nickel / wood, glass, maple, white  
Deckenleuchte; Stahl, nickel-matt / Holz, Glas, ahorn, weiss  
plafonnier; acier, nickel mat / bois, verre, érable, blanc

H 275, Ø 400

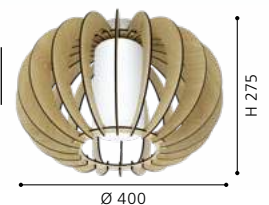

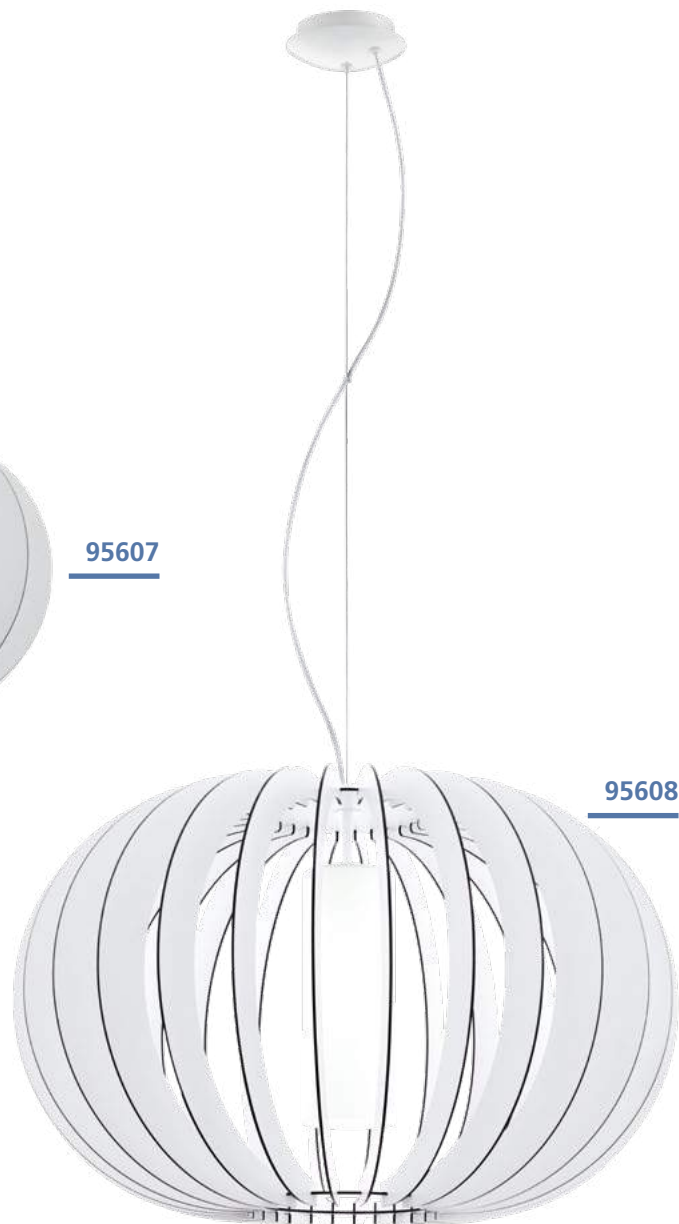

### 95606 STELLATO 2

pendant light; steel, white / wood, glass, white  
 Hängeleuchte; Stahl, weiss / Holz, Glas, weiss  
 luminaire en suspension; acier, blanc / bois, verre, blanc

H 1300, Ø 400

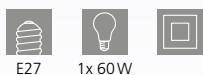

E27 1x 60W



9 002759 956066



### 95607 STELLATO 2

pendant light; steel, white / wood, glass, white  
 Hängeleuchte; Stahl, weiss / Holz, Glas, weiss  
 luminaire en suspension; acier, blanc / bois, verre, blanc

H 1500, Ø 500



E27 1x 60W



9 002759 956073



### 95608 STELLATO 2

pendant light; steel, white / wood, glass, white  
 Hängeleuchte; Stahl, weiss / Holz, Glas, weiss  
 luminaire en suspension; acier, blanc / bois, verre, blanc

H 2000, Ø 700



E27 1x 60W



9 002759 956080



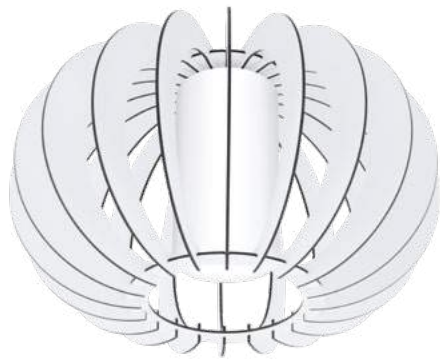

95605



95609



STELLATO 2



DESIGN  
HIGHLIGHT  
DETAIL

### 95609 STELLATO 2

wall light; steel, white / wood, glass, white  
Wandleuchte; Stahl, weiss / Holz, Glas, weiss  
applique; acier, blanc / bois, verre, blanc

L 285, H 250, A 140



E27 1x 60W

### 95605 STELLATO 2

ceiling light; steel, white / wood, glass, white  
Deckenleuchte; Stahl, weiss / Holz, Glas, weiss  
plafonnier; acier, blanc / bois, verre, blanc

H 275, Ø 400



E27 1x 60W



9 002759 956097

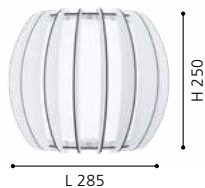

9 002759 956059

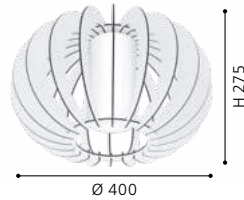



**95591**

**95592**



**95593**

### 95591 STELLATO 3

pendant light; steel, satin nickel / wood, glass, brown, white  
 Hängeleuchte; Stahl, nickel-matt / Holz, Glas, braun, weiss  
 luminaire en suspension; acier, nickel mat / bois, verre, marron, blanc

H 1300, Ø 400



E27

1x 60W



9 002759 955915



H 1300

Ø 400

### 95592 STELLATO 3

pendant light; steel, satin nickel / wood, glass, brown, white  
 Hängeleuchte; Stahl, nickel-matt / Holz, Glas, braun, weiss  
 luminaire en suspension; acier, nickel mat / bois, verre, marron, blanc

H 1500, Ø 500



E27

1x 60W



9 002759 955922



H 1500

Ø 500

### 95593 STELLATO 3

pendant light; steel, satin nickel / wood, glass, brown, white  
 Hängeleuchte; Stahl, nickel-matt / Holz, Glas, braun, weiss  
 luminaire en suspension; acier, nickel mat / bois, verre, marron, blanc

H 2000, Ø 700



E27

1x 60W



9 002759 955939



H 2000

Ø 700





95589



95594



STELLATO 3



DESIGN  
HIGHLIGHT  
DETAIL

### 95594 STELLATO 3

wall light; steel, white / wood, glass, brown, white  
Wandleuchte; Stahl, weiss / Holz, Glas, braun, weiss  
applique; acier, blanc / bois, verre, marron, blanc

L 285, H 250, A 140



9 002759 955946

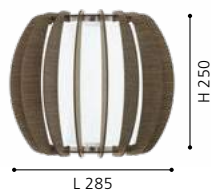

### 95589 STELLATO 3

ceiling light; steel, satin nickel / wood, glass, brown, white  
Deckenleuchte; Stahl, nickel-matt / Holz, Glas, braun, weiss  
plafonnier; acier, nickel mat / bois, verre, marron, blanc

H 275, Ø 400



9 002759 955892

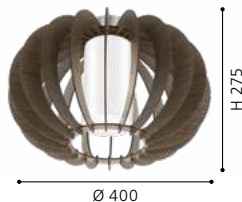



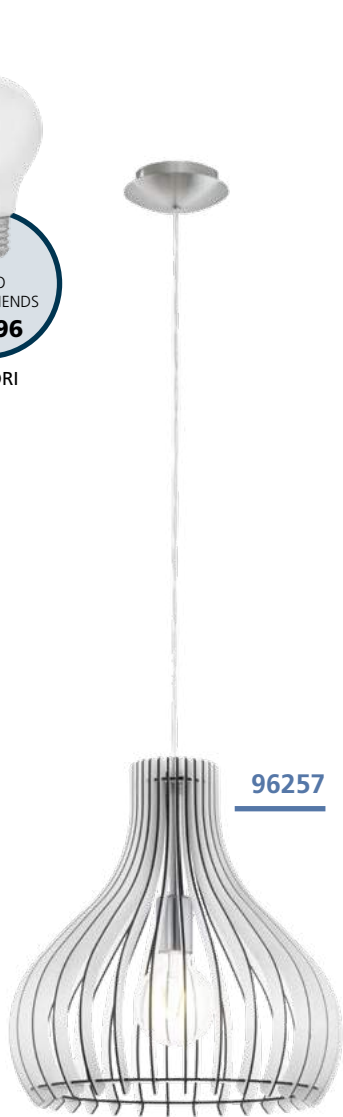

### 96257 TINDORI

pendant light; steel, satin nickel / wood, white  
Hängeleuchte; Stahl, nickel-matt / Holz, weiss  
luminaire en suspension; acier, nickel mat / bois, blanc

H 1300, Ø 380

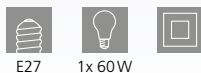

### 96211 TINDORI

pendant light; steel, satin nickel / wood, glass, white  
Hängeleuchte; Stahl, nickel-matt / Holz, Glas, weiss  
luminaire en suspension; acier, nickel mat / bois, verre, blanc

H 1500, Ø 500



### 96258 TINDORI

pendant light; steel, satin nickel / wood, maple  
Hängeleuchte; Stahl, nickel-matt / Holz, ahorn  
luminaire en suspension; acier, nickel mat / bois, érable

H 1300, Ø 380





96214



96259



96219

### 96214 TINDORI

pendant light; steel, satin nickel / wood, glass, maple, white  
 Hängeleuchte; Stahl, nickel-matt / Holz, Glas, ahorn, weiss  
 luminaire en suspension; acier, nickel mat / bois, verre, érable, blanc

H 1500, Ø 500



E27 1x 60W



9 002759 962142



### 96259 TINDORI

pendant light; steel, satin nickel / wood, brown  
 Hängeleuchte; Stahl, nickel-matt / Holz, braun  
 luminaire en suspension; acier, nickel mat / bois, marron

H 1300, Ø 380

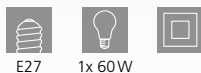

E27 1x 60W



9 002759 962593



### 96219 TINDORI

pendant light; steel, satin nickel / wood, glass, brown, white  
 Hängeleuchte; Stahl, nickel-matt / Holz, Glas, braun, weiss  
 luminaire en suspension; acier, nickel mat / bois, verre, marron, blanc

H 3000, Ø 800



E27 1x 60W



9 002759 962197





**94438**



**94442**

### 94438 COSSANO

pendant light; steel, white / wood, white  
 Hängeleuchte; Stahl, weiss / Holz, weiss  
 luminaire en suspension; acier, blanc / bois, blanc

H 1300, Ø 300

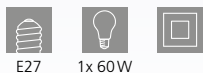

9 002759 944384



### 94442 COSSANO

pendant light; steel, white / wood, white  
 Hängeleuchte; Stahl, weiss / Holz, weiss  
 luminaire en suspension; acier, blanc / bois, blanc

H 1500, Ø 450

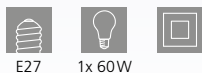

9 002759 944421



### 94439 COSSANO

pendant light; steel, white / wood, white  
 Hängeleuchte; Stahl, weiss / Holz, weiss  
 luminaire en suspension; acier, blanc / bois, blanc

H 1500, Ø 500



9 002759 944391







**94439**



94635



94636



94637

### 94635 COSSANO

pendant light; steel, satin nickel / wood, brown  
 Hängeleuchte; Stahl, nickel-matt / Holz, braun  
 luminaire en suspension; acier, nickel mat / bois, marron

H 1300, Ø 300

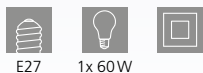

9 002759 946357



### 94636 COSSANO

pendant light; steel, satin nickel / wood, brown  
 Hängeleuchte; Stahl, nickel-matt / Holz, braun  
 luminaire en suspension; acier, nickel mat / bois, marron

H 1500, Ø 500

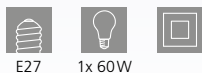

9 002759 946364



### 94637 COSSANO

pendant light; steel, satin nickel / wood, brown  
 Hängeleuchte; Stahl, nickel-matt / Holz, braun  
 luminaire en suspension; acier, nickel mat / bois, marron

H 2000, Ø 700



9 002759 946371





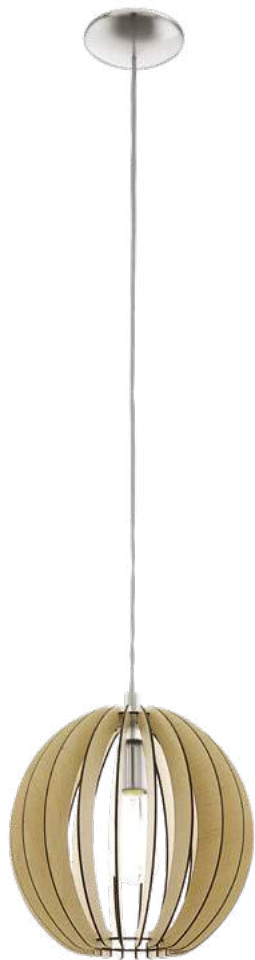

94764



94765



94767

### 94764 COSSANO

pendant light; steel, satin nickel / wood, maple  
Hängeleuchte; Stahl, nickel-matt / Holz, ahorn  
luminaire en suspension; acier, nickel mat / bois, érable

H 1300, Ø 300

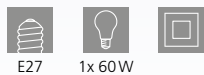

E27 1x 60W



9 002759 947644



### 94765 COSSANO

pendant light; steel, satin nickel / wood, maple  
Hängeleuchte; Stahl, nickel-matt / Holz, ahorn  
luminaire en suspension; acier, nickel mat / bois, érable

H 1500, Ø 500

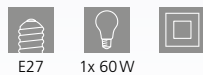

E27 1x 60W



9 002759 947651



### 94767 COSSANO

pendant light; steel, satin nickel / wood, maple  
Hängeleuchte; Stahl, nickel-matt / Holz, ahorn  
luminaire en suspension; acier, nickel mat / bois, érable

H 1500, Ø 450

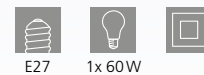

E27 1x 60W



9 002759 947675





95254

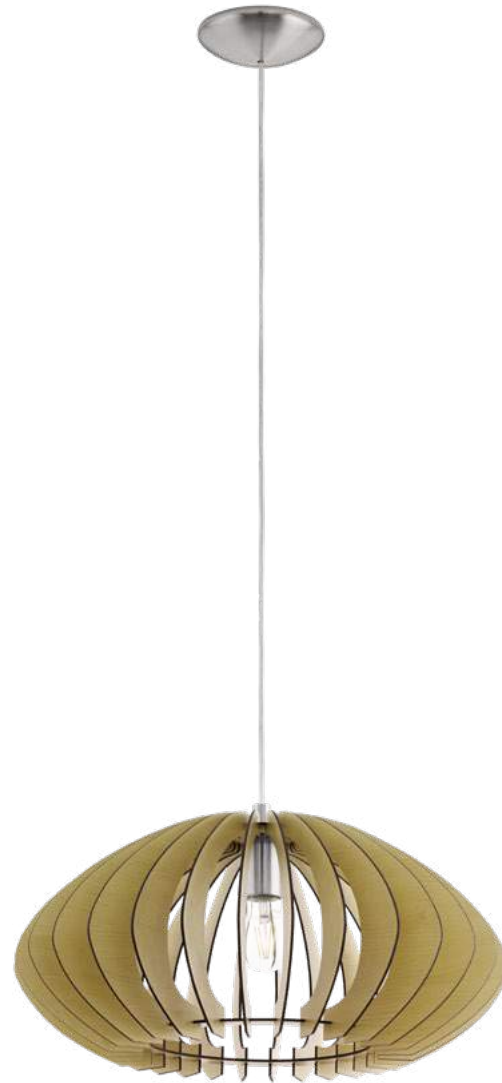

95257

### 95254 COSSANO 2

pendant light; steel, white / wood, white  
 Hängeleuchte; Stahl, weiss / Holz, weiss  
 luminaire en suspension; acier, blanc / bois, blanc

H 1500, Ø 500

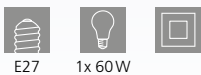

E27 1x 60W



9 002759 952549

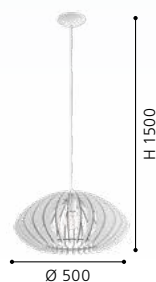

### 95257 COSSANO 2

pendant light; steel, satin nickel / wood, maple  
 Hängeleuchte; Stahl, nickel-matt / Holz, ahorn  
 luminaire en suspension; acier, nickel mat / bois, érable

H 1500, Ø 500

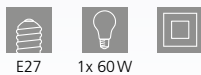

E27 1x 60W



9 002759 952570



### 95261 COSSANO 2

pendant light; steel, satin nickel / wood, dark brown  
 Hängeleuchte; Stahl, nickel-matt / Holz, dunkelbraun  
 luminaire en suspension; acier, nickel mat / bois, marron foncé

H 1500, Ø 500

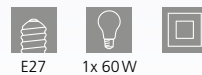

E27 1x 60W



9 002759 952617





95261





**96194**



**96195**



**96193**

### 96194 SENDERO

pendant light; steel, satin nickel / wood, maple  
Hängeleuchte; Stahl, nickel-matt / Holz, ahorn  
luminaire en suspension; acier, nickel mat / bois, érable

L 775, B 250, H 1300



E27



2x 60W



9 002759 961947



### 96193 SENDERO

pendant light; steel, satin nickel / wood, maple  
Hängeleuchte; Stahl, nickel-matt / Holz, ahorn  
luminaire en suspension; acier, nickel mat / bois, érable

H 1300, Ø 450



E27



1x 60W



9 002759 961930



### 96195 SENDERO

wall light; steel, white / wood, maple  
Wandleuchte; Stahl, weiss / Holz, ahorn  
applique; acier, blanc / bois, érable

L 240, H 220, A 120



E27



1x 60W



9 002759 961954

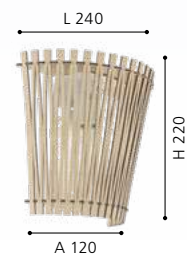





**96199**



**96201**

### 96199 SENDERO

pendant light; steel, satin nickel / wood, brown  
 Hängeleuchte; Stahl, nickel-matt / Holz, braun  
 luminaire en suspension; acier, nickel mat / bois, marron

H 1300, Ø 450



9 002759 961992



### 96201 SENDERO

pendant light; steel, satin nickel / wood, brown  
 Hängeleuchte; Stahl, nickel-matt / Holz, braun  
 luminaire en suspension; acier, nickel mat / bois, marron

L 775, B 250, H 1300

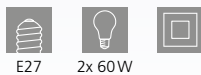

9 002759 962012





# LIGHTING FAMILIES

STANDARD LUMINAIRES  
STANDARD LEUCHTEN  
LUMINAIRES STANDARD

## **FAMILY MEETING -**

This range combines ceiling, wall, suspended, floor and table luminaires. Give your rooms a consistent and stylish all-round illumination.

## **FAMILIENTREFFEN -**

Dieses Sortiment vereint sowohl Decken-, Wand- und Hängeleuchten als auch Tisch- und Stehleuchten. Verleihen Sie Ihren Räumlichkeiten eine einheitliche und stilvolle Rundumbeleuchtung.







## **RENCONTRE FAMILIALE -**

Cette gamme réunit aussi bien des plafonniers, des éclairages muraux, des éclairages suspendus que des lampes de table et des lampadaires. Donnez à vos pièces un éclairage d'ensemble unifié et riche en style.



# OVERVIEW

LIGHTING FAMILIES / STANDARD

							
TURALDO p. 196	LIBERTAD p. 198-199	CAMACHO p. 200-201	BOYAL p. 202-205	AZBARREN p. 206	TAREGA p. 208	SILVARES p. 209	CANTERRAS p. 210-211
							
ABREOSA p. 212	CASIBARE p. 214-215	CREMELLA p. 216-217	CORTADERAS p. 218-219	NARICES p. 220-221	ESCANDIDOS p. 222-223	TABIAGO p. 224	ERSEKA p. 226-227
							
CLEMENTE p. 228-229	BONARES 1 p. 230-231	BELESER p. 232-233	GOROSIBA 1 p. 234	GOROSIBA p. 234-235	MANTUNALLE 1 p. 236-237	MANTUNALLE p. 238-239	OPTICA p. 240-243
							
RONDO p. 244-245	VALLASPA p. 246-247	PINTO TEXTIL p. 248-249	PINTO NERO p. 250	PINTO GOLD p. 252-253	PINTO p. 254-255	TROY 3 p. 256-257	RIVATO p. 258-259
							
BAYMAN p. 259	AMADORA p. 260	BATISTA 3 p. 261	VINOVO p. 262	MURCIA p. 262-263	SAVOY p. 264-265	MARBELLA p. 266-267	ERVIDEL p. 268-269
							
ISIDRO p. 270-271	PALBIETA p. 272-273	PHIANEROS p. 274	EGIDONELLA p. 276-277	ALAMEDILLA p. 278	BANDERILLAS p. 278-279	LEIJAS p. 280-281	LASANA 3 p. 282-283
							
LASANA 2 p. 284-285, 287	LASANA 1 p. 285-287	LASANA p. 286	RONCADE 1 p. 288	SELVINA 1 p. 288	RONCADE p. 289, 296	PAUSIA p. 290	SELVINA p. 290-291



This product is available in different colors and shapes./ Dieser Artikel ist in unterschiedlichen Farben und Formen verfügbar.  
Cet article est disponible en différentes couleurs et formes.



VALMORA  
p. 292-293



NEVADO  
p. 293



PERTINI  
p. 294



TARANDELL  
p. 295



LAPELA  
p. 295



PALOZZA 1  
p. 296



PALOZZA  
p. 298-299



NOVAFELTRIA  
p. 300-301





DESIGN  
HIGHLIGHT  
DETAIL



99077



99079

### 99077 TURALDO

ceiling light; wood, brown  
Deckenleuchte; Holz, braun  
plafonnier; bois, marron

H 80, Ø 70



E27 1x 28W



9 002759 990770

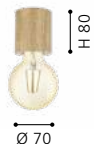

### 99079 TURALDO

table light; wood, brown  
Tischleuchte; Holz, braun  
luminaire de table; bois, marron

H 100, Ø 85



E27 1x 28W



9 002759 990794



### 99078 TURALDO

pendant light; wood, steel, brown, black  
Hängeleuchte; Holz, Stahl, braun, schwarz  
luminaire en suspension; bois, acier, marron, noir

H 1100, Ø 105



E27 1x 28W



9 002759 990787

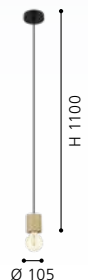





99078

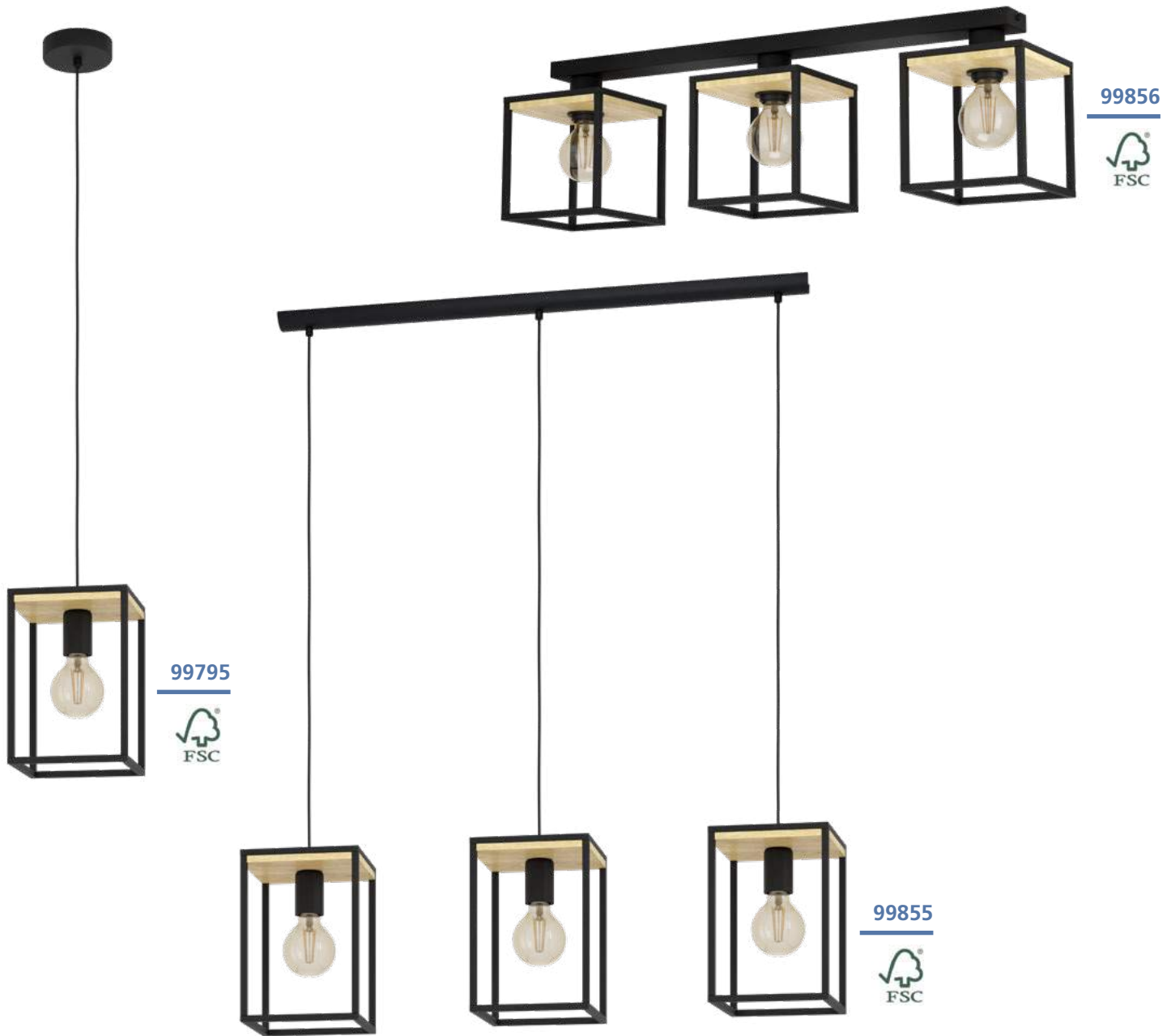

### 99795 LIBERTAD

pendant light; steel, wood, black, brown  
 Hängeleuchte; Stahl, Holz, schwarz, braun  
 luminaire en suspension; acier, bois, noir, marron

L 180, B 180, H 1100



E27 1x 40W



9 002759 997953

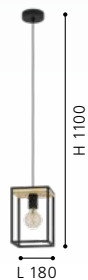

L 180

### 99855 LIBERTAD

pendant light; steel, wood, black, brown  
 Hängeleuchte; Stahl, Holz, schwarz, braun  
 luminaire en suspension; acier, bois, noir, marron

L 880, B 180, H 1100



E27 3x 40W



9 002759 998554



L 880

### 99856 LIBERTAD

ceiling light; steel, wood, black, brown  
 Deckenleuchte; Stahl, Holz, schwarz, braun  
 plafonnier; acier, bois, noir, marron

L 860, B 180, H 240



E27 3x 40W



9 002759 998561

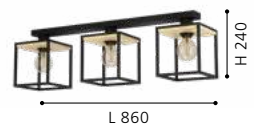

L 860



99796



99798



99797



### 99796 LIBERTAD

wall light; steel, wood, black, brown  
Wandleuchte; Stahl, Holz, schwarz, braun  
applique; acier, bois, noir, marron

L 140, H 240, A 165



E27 1x 40W



9 002759 997960



### 99798 LIBERTAD

floor light; steel, wood, black, brown  
Stehleuchte; Stahl, Holz, schwarz, braun  
lampadaire; acier, bois, noir, marron

L 180, B 180, H 1285



E27 1x 40W



9 002759 997984

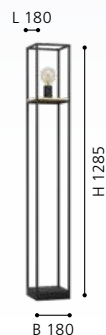

### 99797 LIBERTAD

table light; steel, wood, black, brown  
Tischleuchte; Stahl, Holz, schwarz, braun  
luminaire de table; acier, bois, noir, marron

L 140, B 140, H 350



E27 1x 40W



9 002759 997977





### 99293 CAMACHO

pendant light; steel, wood, black, brown / plastic, white  
 Hängeleuchte; Stahl, Holz, schwarz, braun / Kunststoff, weiss  
 luminaire en suspension; acier, bois, noir, marron / plastique, blanc

L 1100, B 60, H 1100



25,5W 3100lm



9 002759 992934

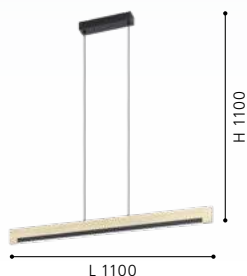

### 99292 CAMACHO

ceiling light; steel, wood, black, brown / plastic, white  
 Deckenleuchte; Stahl, Holz, schwarz, braun / Kunststoff, weiss  
 plafonnier; acier, bois, noir, marron / plastique, blanc

L 940, B 80, H 115



2x 10W 2x 1300lm



9 002759 992927

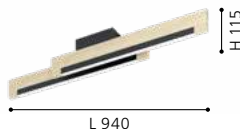

### 99294 CAMACHO

wall light; steel, wood, black, brown / plastic, white  
 Wandleuchte; Stahl, Holz, schwarz, braun / Kunststoff, weiss  
 applique; acier, bois, noir, marron / plastique, blanc

L 440, H 105, A 75



1x 8,5W 1x 1050lm



9 002759 992941





TOUCH  
ME



99296



99295



99295, 99296

These luminaires can be switched on and off by touching the specially designed "Touch Me" part of the fixture.

Diese Leuchten können ein- und ausgeschaltet werden, indem man sie an den dafür vorgesehenen "Touch Me" Bereichen berührt.

Ces luminaires peuvent être éteints et allumés simplement en touchant la partie spécialement conçue pour "Touch Me" du luminaire.

### 99296 CAMACHO

floor light; steel, wood, black, brown / plastic, white  
Stehleuchte; Stahl, Holz, schwarz, braun / Kunststoff, weiss  
lampadaire; acier, bois, noir, marron / plastique, blanc

H 1260, Base: B 250, T 200



22 W



2400lm



9 002759 992965



### 99295 CAMACHO

table light; steel, wood, black, brown / plastic, white  
Tischleuchte; Stahl, Holz, schwarz, braun / Kunststoff, weiss  
luminaire de table; acier, bois, noir, marron / plastique, blanc

H 405, Base: B 150, T 130



1x 6,5 W



1x

800lm



9 002759 992958







99413



99624



### 99624 BOYAL

pendant light; steel, wood, black, brown rustic / ceramics, white  
 Hängeleuchte; Stahl, Holz, schwarz, braun rustikal / Keramik, weiss  
 luminaire en suspension; acier, bois, noir, marron rustique / céramique, blanc

L 1010, B 400, H 1100

12,5W	1800lm	12,5W	1800lm	15,5W

2250lm		



### 99413 BOYAL

ceiling light; steel, wood, black, brown rustic / plastic, white  
 Deckenleuchte; Stahl, Holz, schwarz, braun rustikal / Kunststoff, weiss  
 plafonnier; acier, bois, noir, marron rustique / plastique, blanc

L 1010, B 400, H 95

2x 12W	2x 1700lm	1x 12W	1x 1700lm	





99353



99457



99408



### 99353 BOYAL

wall light; steel, wood, black, brown rustic / plastic, white  
 Wandleuchte; Stahl, Holz, schwarz, braun rustikal / Kunststoff, weiss  
 applique; acier, bois, noir, marron rustique / plastique, blanc

L 300, H 560, A 75



1x 12W  
 1x  
 1700lm



9 002759 993535



### 99457 BOYAL

table light; steel, wood, black, brown rustic / plastic, white  
 Tischleuchte; Stahl, Holz, schwarz, braun rustikal / Kunststoff, weiss  
 luminaire de table; acier, bois, noir, marron rustique / plastique, blanc

L 300, B 150, H 425, Base: B 110, T 150



1x 12W  
 1x  
 1700lm



9 002759 994570



### 99408 BOYAL

ceiling light; steel, wood, black, brown rustic / plastic, white  
 Deckenleuchte; Stahl, Holz, schwarz, braun rustikal / Kunststoff, weiss  
 plafonnier; acier, bois, noir, marron rustique / plastique, blanc

L 780, B 400, H 90

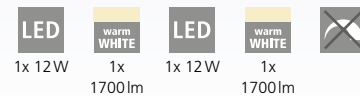

1x 12W  
 1x  
 1700lm  
 1x 12W  
 1x  
 1700lm



9 002759 994082



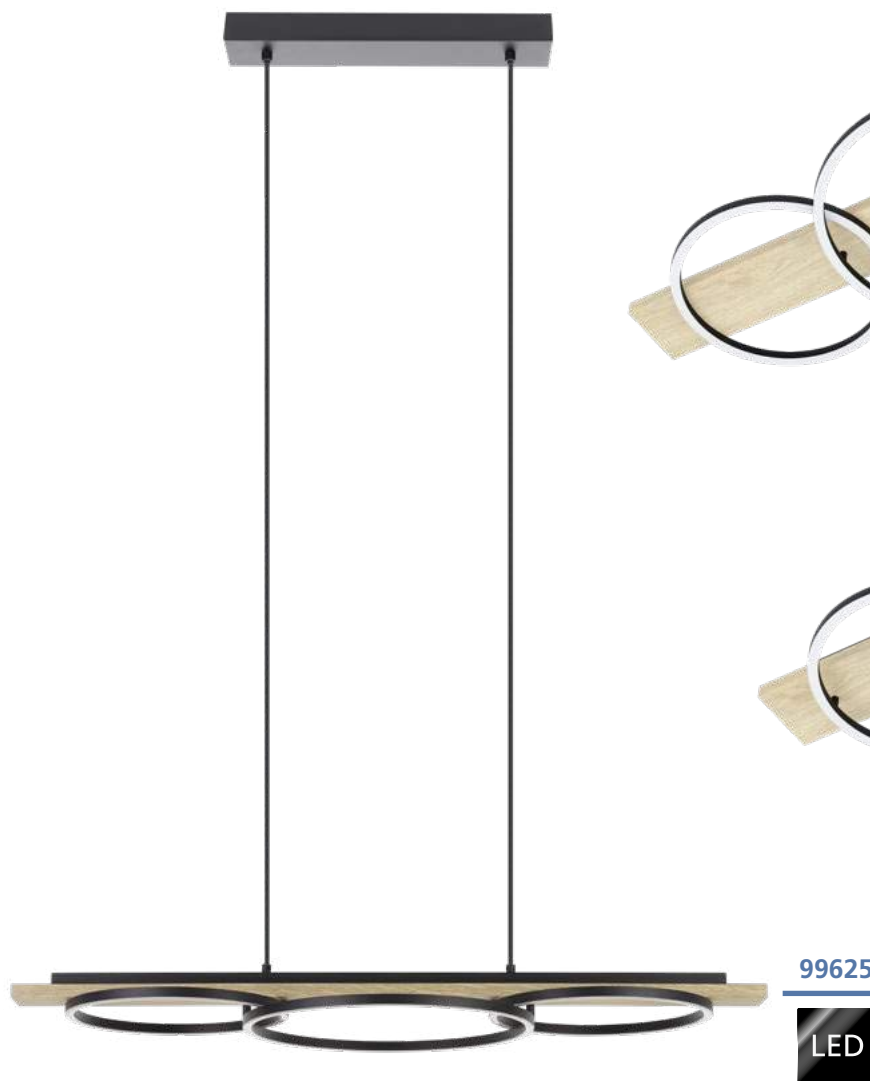

99468

LED

99467

LED

99625

LED

### 99625 BOYAL

pendant light; steel, black, brown / ceramics, white  
 Hängeleuchte; Stahl, schwarz, braun / Keramik, weiss  
 luminaire en suspension; acier, noir, marron / céramique, blanc

L 1010, B 400, H 1100

LED 12,5W warm WHITE 1800lm LED 12,5W warm WHITE 1800lm LED 15,5W

warm WHITE 2250lm



9 002759 996253

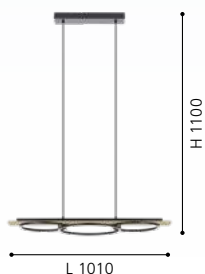

### 99468 BOYAL

ceiling light; steel, wood, black, brown / plastic, white  
 Deckenleuchte; Stahl, Holz, schwarz, braun / Kunststoff, weiss  
 plafonnier; acier, bois, noir, marron / plastique, blanc

L 1010, B 400, H 95

LED 2x 12W warm WHITE 1700lm LED 1x 12W warm WHITE 1700lm



9 002759 994686



### 99467 BOYAL

ceiling light; steel, wood, black, brown / plastic, white  
 Deckenleuchte; Stahl, Holz, schwarz, braun / Kunststoff, weiss  
 plafonnier; acier, bois, noir, marron / plastique, blanc

L 780, B 400, H 90

LED 1x 12W warm WHITE 1700lm LED 1x 12W warm WHITE 1700lm



9 002759 994679

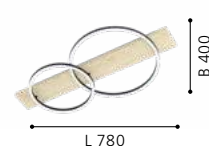



99469

LED



99466

LED

### 99469 BOYAL

table light; steel, wood, black, brown / plastic, white  
Tischleuchte; Stahl, Holz, schwarz, braun / Kunststoff, weiss  
luminaire de table; acier, bois, noir, marron / plastique, blanc

L 300, B 150, H 425, Base: B 110, T 150



9 002759 994693



### 99466 BOYAL

wall light; steel, wood, black, brown / plastic, white  
Wandleuchte; Stahl, Holz, schwarz, braun / Kunststoff, weiss  
applique; acier, bois, noir, marron / plastique, blanc

L 300, H 560, A 75



9 002759 994662





**39753**



**39752**

### 39753 AZBARREN

table light; steel, beige / ceramics, grey  
Tischleuchte; Stahl, beige / Keramik, grau  
luminaire de table; acier, beige / céramique, gris

H 535, Ø 300, Base: Ø 145



E27 1x 40W



9 002759 397531



### 39752 AZBARREN

pendant light; steel, beige / ceramics, grey  
Hängeleuchte; Stahl, beige / Keramik, grau  
luminaire en suspension; acier, beige / céramique, gris

L 1195, B 145, H 1500

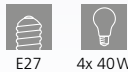

E27 4x 40W



9 002759 397524



### 39751 AZBARREN

pendant light; steel, beige / ceramics, grey  
Hängeleuchte; Stahl, beige / Keramik, grau  
luminaire en suspension; acier, beige / céramique, gris

H 1500, Ø 145



E27 1x 40W



9 002759 397517







**39751**





95526



95525

95527

### 95526 TAREGA

pendant light; steel, grey / wood, concrete, brown, grey  
 Hängeleuchte; Stahl, grau / Holz, Beton, braun, grau  
 luminaire en suspension; acier, gris / bois, béton, marron, gris

H 1500, Ø 250



E27



3x 40W



9 002759 955267



### 95525 TAREGA

pendant light; steel, grey / wood, concrete, brown, grey  
 Hängeleuchte; Stahl, grau / Holz, Beton, braun, grau  
 luminaire en suspension; acier, gris / bois, béton, marron, gris

H 1100, Ø 150



E27



1x 40W



9 002759 955250



### 95527 TAREGA

table light; wood, concrete, brown, grey / fabric, brown  
 Tischleuchte; Holz, Beton, braun, grau / Textil, braun  
 luminaire de table; bois, béton, marron, gris / tissu, marron

H 370, Ø 250, Base: Ø 150



E27



1x 60W



9 002759 955274





**95522**



**95523**



**95524**

### 95522 SILVARES

pendant light; steel, grey / concrete, grey  
Hängeleuchte; Stahl, grau / Beton, grau  
luminaire en suspension; acier, gris / béton, gris

H 1100, Ø 110



E27



1x 60W



9 002759 955229

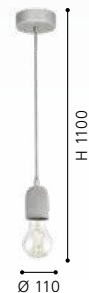

Ø 110

### 95523 SILVARES

pendant light; steel, grey / concrete, grey  
Hängeleuchte; Stahl, grau / Beton, grau  
luminaire en suspension; acier, gris / béton, gris

H 1500, Ø 250



E27



3x 60W



9 002759 955236



Ø 250

### 95524 SILVARES

pendant light; steel, grey / concrete, grey  
Hängeleuchte; Stahl, grau / Beton, grau  
luminaire en suspension; acier, gris / béton, gris

H 1500, Ø 350



E27



5x 60W



9 002759 955243



Ø 350





99545



99544

### 99545 CANTERRAS

pendant light; steel, black / terrazzo, grey, white  
 Hängeleuchte; Stahl, schwarz / Terrazzo, grau, weiss  
 luminaire en suspension; acier, noir / terrazzo, gris, blanc

L 975, B 150, H 1100



### 99544 CANTERRAS

pendant light; steel, black / terrazzo, grey, white  
 Hängeleuchte; Stahl, schwarz / Terrazzo, grau, weiss  
 luminaire en suspension; acier, noir / terrazzo, gris, blanc

H 1100, Ø 150

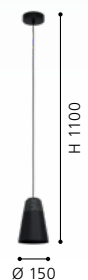
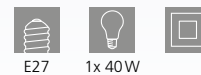



99546



99547



### 99546 CANTERRAS

wall light; steel, black / terrazzo, grey, white  
Wandleuchte; Stahl, schwarz / Terrazzo, grau, weiss  
applique; acier, noir / terrazzo, gris, blanc

L 150, H 320, A 275



E27



1x 40W



9 002759 995461



### 99547 CANTERRAS

floor light; steel, black / terrazzo, grey, white  
Stehleuchte; Stahl, schwarz / Terrazzo, grau, weiss  
lampadaire; acier, noir / terrazzo, gris, blanc

L 430, B 150, H 1785, Base: Ø 300



E27



1x 40W



9 002759 995478

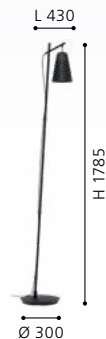





99513



99512

### 99513 ABREOSA

floor light; steel, black, grey  
 Stehleuchte; Stahl, schwarz, grau  
 lampadaire; acier, noir, gris

L 370, B 280, H 1510, Base: Ø 250

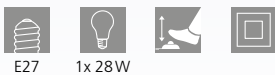

E27 1x 28W



9 002759 995133

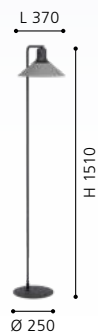

### 99512 ABREOSA

pendant light; steel, black, grey  
 Hängeleuchte; Stahl, schwarz, grau  
 luminaire en suspension; acier, noir, gris

L 1080, B 280, H 1100



E27 3x 28W



9 002759 995126

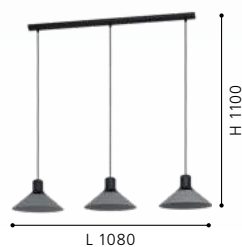

### 99511 ABREOSA

pendant light; steel, black, grey  
 Hängeleuchte; Stahl, schwarz, grau  
 luminaire en suspension; acier, noir, gris

H 1100, Ø 280

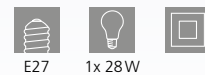

E27 1x 28W



9 002759 995119

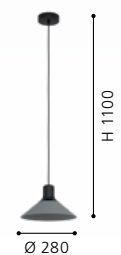



99511





### 99551 CASIBARE

pendant light; steel, black  
Hängeleuchte; Stahl, schwarz  
luminaire en suspension; acier, noir

H 1100, Ø 150

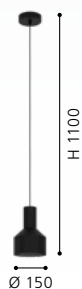

### 99552 CASIBARE

pendant light; steel, black  
Hängeleuchte; Stahl, schwarz  
luminaire en suspension; acier, noir

L 850, B 150, H 1100

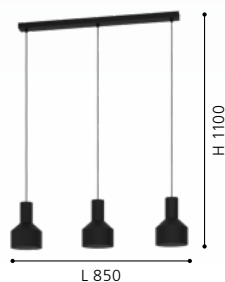

### 99553 CASIBARE

pendant light; steel, black  
Hängeleuchte; Stahl, schwarz  
luminaire en suspension; acier, noir

H 1500, Ø 710

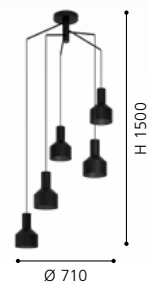



99554



99555

### 99554 CASIBARE

table light; steel, black  
Tischleuchte; Stahl, schwarz  
luminaire de table; acier, noir

L 160, B 120, H 490, Base: Ø 155

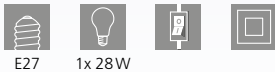

E27 1x 28W



9 002759 995546



### 99555 CASIBARE

floor light; steel, black  
Stehleuchte; Stahl, schwarz  
lampadaire; acier, noir

L 350, B 120, H 1605, Base: Ø 250

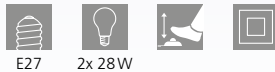

E27 2x 28W



9 002759 995553

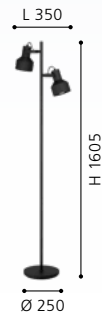



**99345**



**99346**

**99345 CREMELLA**

pendant light; steel, black  
 Hängeleuchte; Stahl, schwarz  
 luminaire en suspension; acier, noir

H 1100, Ø 370

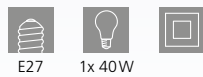

E27 1x 40W



9 002759 993450



**99346 CREMELLA**

pendant light; steel, black  
 Hängeleuchte; Stahl, schwarz  
 luminaire en suspension; acier, noir

H 1100, Ø 180

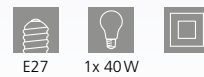

E27 1x 40W



9 002759 993467





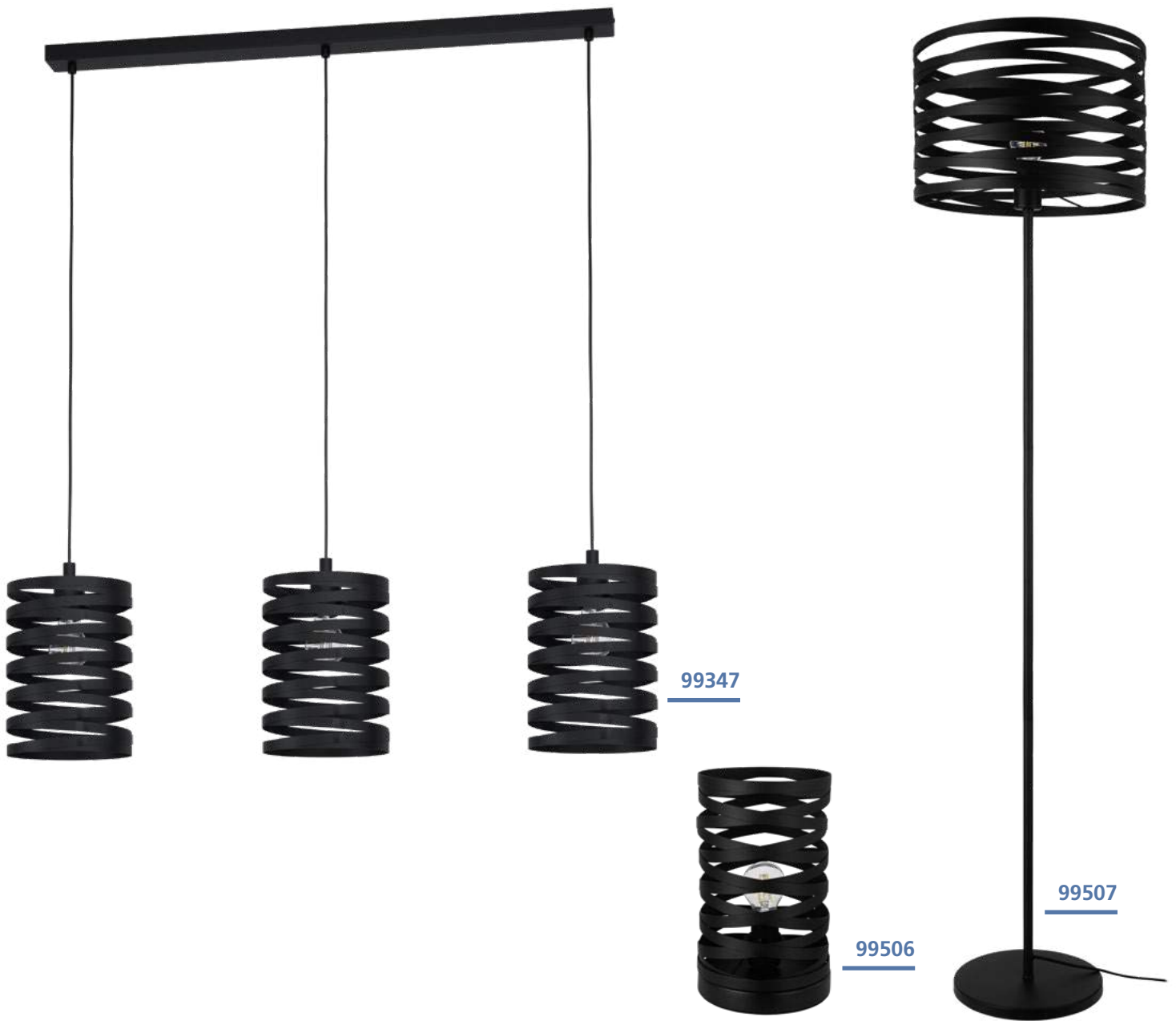

### 99347 CREMELLA

pendant light; steel, black  
 Hängeleuchte; Stahl, schwarz  
 luminaire en suspension; acier, noir

L 940, B 180, H 1100



E27 3x 40W



9 002759 993474

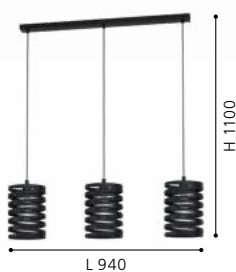

### 99506 CREMELLA

table light; steel, black  
 Tischleuchte; Stahl, schwarz  
 luminaire de table; acier, noir

H 290, Ø 180, Base: Ø 180



E27 1x 40W



9 002759 995065



### 99507 CREMELLA

floor light; steel, black  
 Stehleuchte; Stahl, schwarz  
 lampadaire; acier, noir

H 1510, Ø 370, Base: Ø 250



E27 1x 40W



9 002759 995072

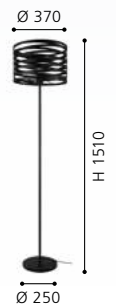

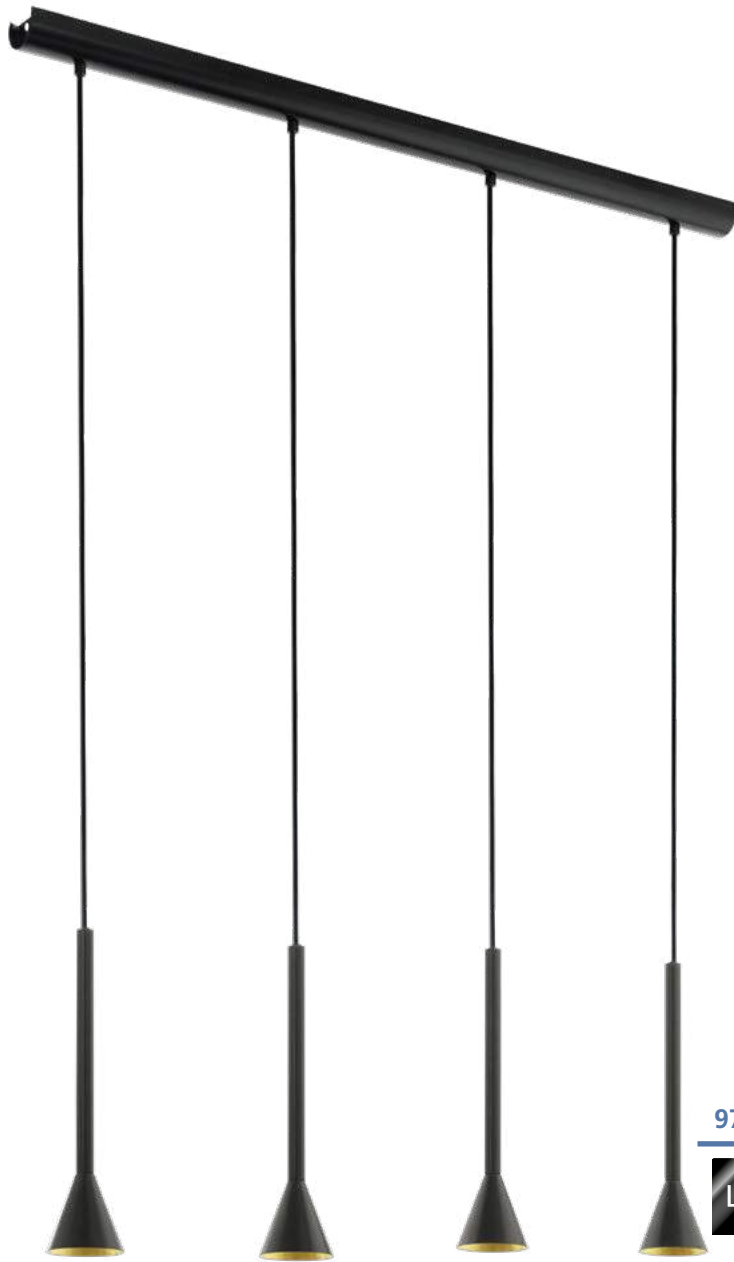

97605

LED



97804

LED



97805

LED

### 97605 CORTADERAS

pendant light; steel, black, gold  
Hängeleuchte; Stahl, schwarz, gold  
luminaire en suspension; acier, noir, or

L 1130, B 85, H 1500



GU10



4x 5W



4x  
400lm

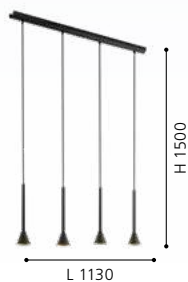

9 002759 976057



### 97805 CORTADERAS

table light; steel, black, gold  
Tischleuchte; Stahl, schwarz, gold  
luminaire de table; acier, noir, or

L 235, B 150, H 445, Base: Ø 150



GU10



1x 5W



1x  
400lm



9 002759 978051



### 97804 CORTADERAS

wall light; steel, black, gold  
Wandleuchte; Stahl, schwarz, gold  
applique; acier, noir, or

H 200, Ø 120



GU10



1x 5W



1x  
400lm



9 002759 978044





97604

LED

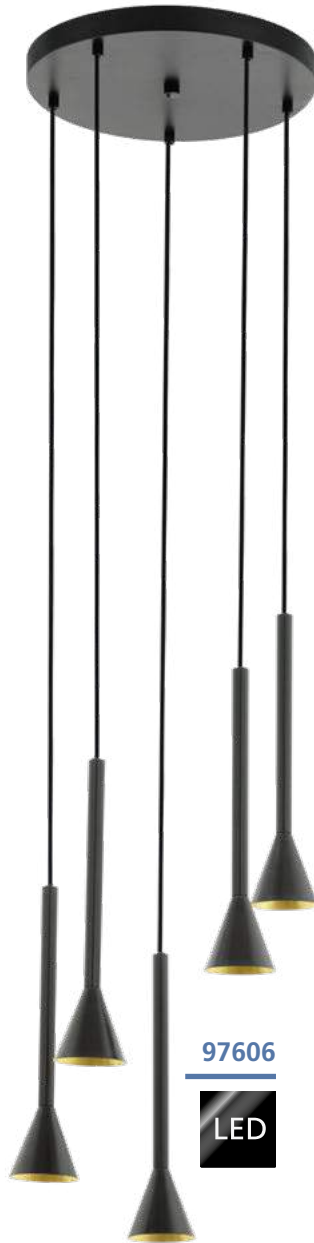

97606

LED



97806

LED

### 97604 CORTADERAS

pendant light; steel, black, gold  
Hängeleuchte; Stahl, schwarz, gold  
luminaire en suspension; acier, noir, or

H 1500, Ø 95



GU10



1x 5W



warm  
WHITE

1x

400lm



9 002759 976040



H 1500

Ø 95

### 97606 CORTADERAS

pendant light; steel, black, gold  
Hängeleuchte; Stahl, schwarz, gold  
luminaire en suspension; acier, noir, or

H 1500, Ø 350



GU10



5x 5W



warm  
WHITE

5x

400lm



9 002759 976064



H 1500

Ø 350

### 97806 CORTADERAS

floor light; steel, black, gold  
Stehleuchte; Stahl, schwarz, gold  
lampadaire; acier, noir, or

H 1445, Ø 250, Base: Ø 250



GU10



2x 5W



warm  
WHITE

2x

400lm



9 002759 978068

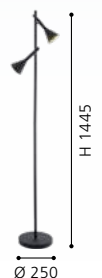

H 1445

Ø 250



99592



DESIGN  
HIGHLIGHT  
DETAIL

### 99592 NARICES

pendant light; steel, black / steel, brushed brass, gold  
Hängeleuchte; Stahl, schwarz / Stahl, messing-gebürstet, gold  
luminaire en suspension; acier, noir / acier, laiton brossé, or

L 920, B 220, H 1100



E27



3x 40W

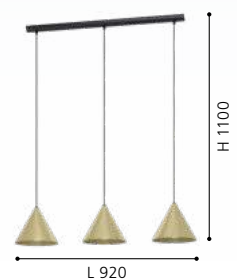

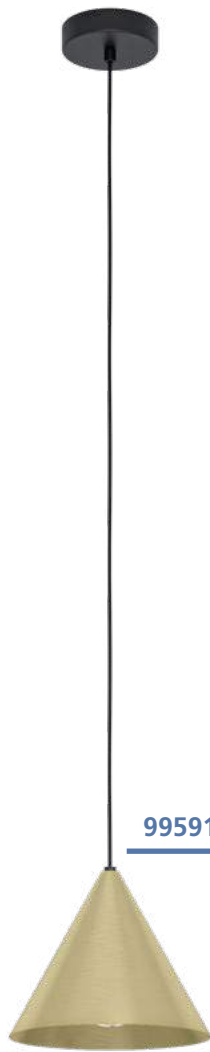

99591



99593



99594

### 99591 NARICES

pendant light; steel, black / steel, brushed brass, gold  
Hängeleuchte; Stahl, schwarz / Stahl, messing-gebürstet, gold  
luminaire en suspension; acier, noir / acier, laiton brossé, or

H 1100, Ø 220



E27 1x 40W



9 002759 995911



### 99593 NARICES

table light; steel, black / steel, brushed brass, gold  
Tischleuchte; Stahl, schwarz / Stahl, messing-gebürstet, gold  
luminaire de table; acier, noir / acier, laiton brossé, or

L 295, B 220, H 500, Base: Ø 220



E27 1x 40W



9 002759 995935



### 99594 NARICES

floor light; steel, black / steel, brushed brass, gold  
Stehleuchte; Stahl, schwarz / Stahl, messing-gebürstet, gold  
lampadaire; acier, noir / acier, laiton brossé, or

L 295, B 220, H 1620, Base: Ø 270



E27 1x 40W



9 002759 995942

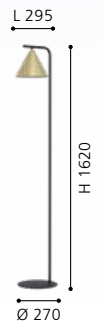





99806



99807

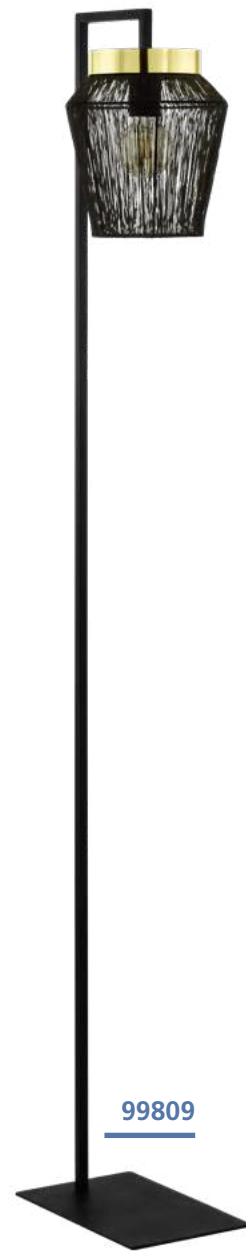

99809

### 99806 ESCANDIDOS

pendant light; steel, black, brass / steel, black, gold  
 Hängeleuchte; Stahl, schwarz, messing / Stahl, schwarz, gold  
 luminaire en suspension; acier, noir, laiton / acier, noir, or

H 1100, Ø 220



E27 1x 40W



9 002759 998066

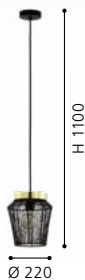

### 99807 ESCANDIDOS

pendant light; steel, black, brass / steel, black, gold  
 Hängeleuchte; Stahl, schwarz, messing / Stahl, schwarz, gold  
 luminaire en suspension; acier, noir, laiton / acier, noir, or

L 920, B 220, H 1100



E27 3x 40W



9 002759 998073



### 99809 ESCANDIDOS

floor light; steel, black, brass / steel, black, gold  
 Stehleuchte; Stahl, schwarz, messing / Stahl, schwarz, gold  
 lampadaire; acier, noir, laiton / acier, noir, or

L 310, B 220, H 1700, Base: B 300, T 200

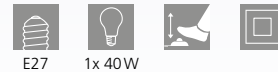

E27 1x 40W



9 002759 998097

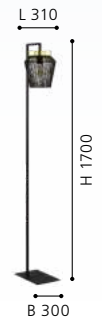



99808

### 99808 ESCANDIDOS

table light; steel, black, brass / steel, black, gold  
Tischleuchte; Stahl, schwarz, messing / Stahl, schwarz, gold  
luminaire de table; acier, noir, laiton / acier, noir, or

H 260, Ø 220, Base: Ø 150



E27



1x 40W



9 002759 998080





**99018**



**99017**

### 99018 TABIAGO

table light; steel, black / steel, rose gold  
Tischleuchte; Stahl, schwarz / Stahl, roségold  
luminaire de table; acier, noir / acier, or rose

H 300, Ø 130



9 002759 990183



### 99017 TABIAGO

pendant light; steel, black / steel, rose gold  
Hängeleuchte; Stahl, schwarz / Stahl, roségold  
luminaire en suspension; acier, noir / acier, or rose

L 890, B 130, H 1100



9 002759 990176



### 99016 TABIAGO

pendant light; steel, black / steel, rose gold  
Hängeleuchte; Stahl, schwarz / Stahl, roségold  
luminaire en suspension; acier, noir / acier, or rose

H 1100, Ø 130

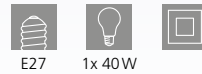

9 002759 990169

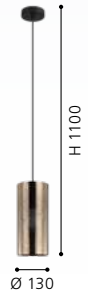





**99016**



99098



99096



99097

### 99098 ERSEKA

pendant light; steel, brass / crystal, clear  
 Hängeleuchte; Stahl, messing / Kristall, klar  
 luminaire en suspension; acier, laiton / cristal, clair

H 1300, Ø 385



E14 5x 40W



### 99097 ERSEKA

pendant light; steel, brass / crystal, clear  
 Hängeleuchte; Stahl, messing / Kristall, klar  
 luminaire en suspension; acier, laiton / cristal, clair

H 1450, Ø 485



E14 7x 40W



### 99096 ERSEKA

ceiling light; steel, brass / crystal, clear  
 Deckenleuchte; Stahl, messing / Kristall, klar  
 plafonnier; acier, laiton / cristal, clair

H 535, Ø 485



E14 7x 40W

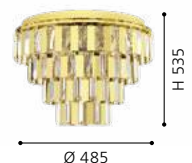





### 99095 ERSEKA

pendant light; steel, chrome / crystal, clear  
Hängeleuchte; Stahl, chrom / Kristall, klar  
luminaire en suspension; acier, chrome / cristal, clair

H 1300, Ø 385

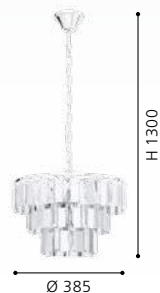

### 99094 ERSEKA

pendant light; steel, chrome / crystal, clear  
Hängeleuchte; Stahl, chrom / Kristall, klar  
luminaire en suspension; acier, chrome / cristal, clair

H 1450, Ø 485

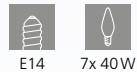

### 99093 ERSEKA

ceiling light; steel, chrome / crystal, clear  
Deckenleuchte; Stahl, chrom / Kristall, klar  
plafonnier; acier, chrome / cristal, clair

H 535, Ø 485





95287

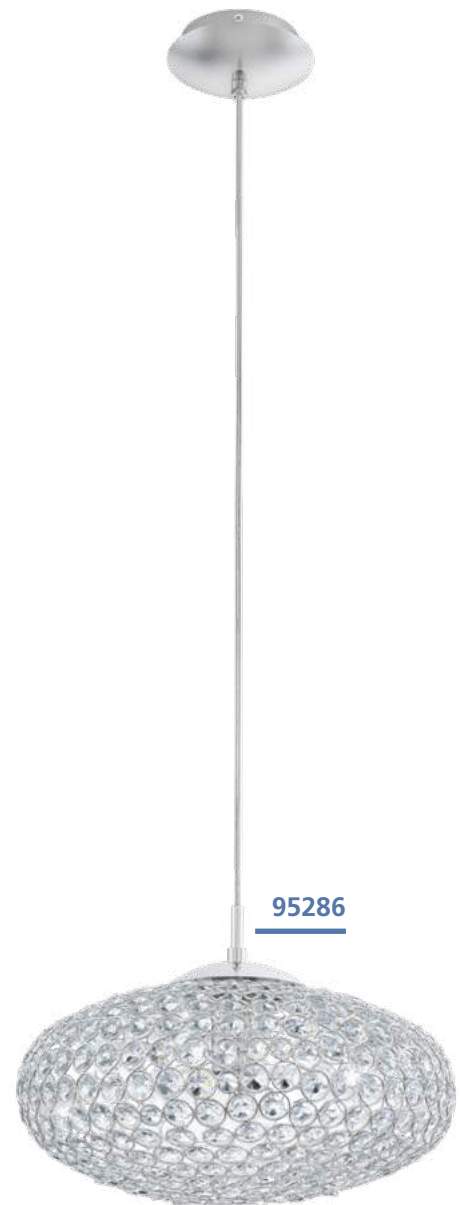

95286



DESIGN  
HIGHLIGHT  
DETAIL

**95287 CLEMENTE**

pendant light; steel, chrome / crystal, clear  
Hängeleuchte; Stahl, chrom / Kristall, klar  
luminaire en suspension; acier, chrome / cristal, clair

H 1100, Ø 540



E27



3x 60W



9 002759 952877





**95285**



**95284**

**95286 CLEMENTE**

pendant light; steel, chrome / crystal, clear  
Hängeleuchte; Stahl, chrom / Kristall, klar  
luminaire en suspension; acier, chrome / cristal, clair

H 1100, Ø 350

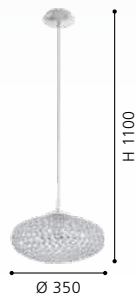

**95284 CLEMENTE**

ceiling light; steel, chrome / crystal, clear  
Deckenleuchte; Stahl, chrom / Kristall, klar  
plafonnier; acier, chrome / cristal, clair

H 200, Ø 350

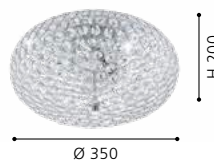

**95285 CLEMENTE**

ceiling light; steel, chrome / crystal, clear  
Deckenleuchte; Stahl, chrom / Kristall, klar  
plafonnier; acier, chrome / cristal, clair

H 205, Ø 450

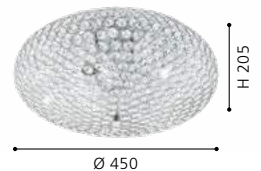





**94896**



**94899**



**BONARES 1**

### 94896 BONARES 1

pendant light; steel, chrome / steel, crystal, chrome, clear  
Hängeleuchte; Stahl, chrom / Stahl, Kristall, chrom, klar  
luminaire en suspension; acier, chrome / acier, cristal, chrome, clair

H 1100, Ø 130



E27



1x 60W



9 002759 948962



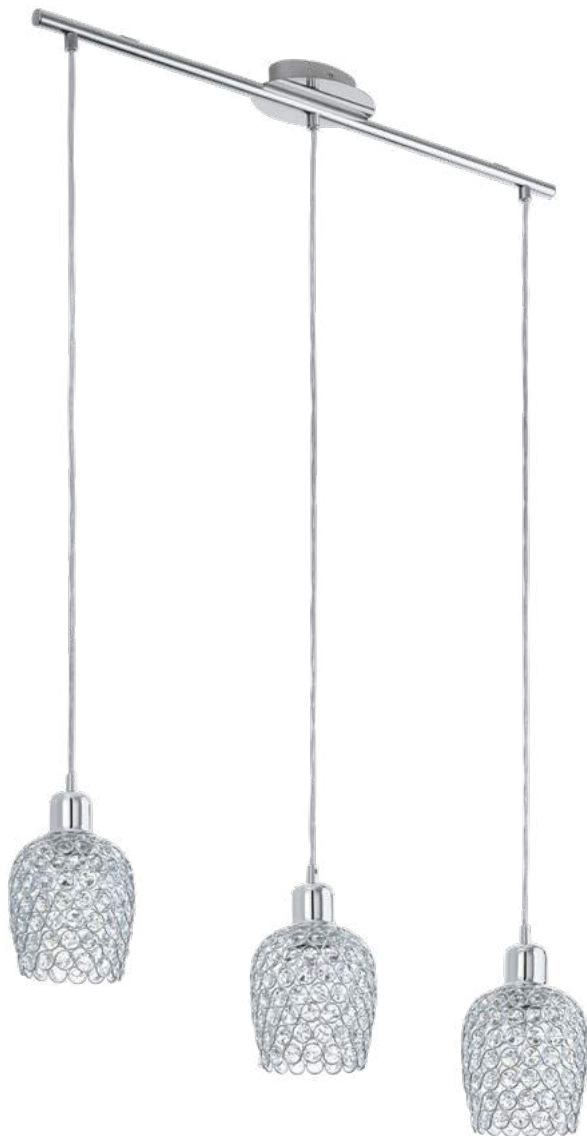

**94897**



**94898**

**94899 BONARES 1**

table light; steel, chrome / steel, crystal, chrome, clear  
Tischleuchte; Stahl, chrom / Stahl, Kristall, chrom, klar  
luminaire de table; acier, chrome / acier, cristal, chrome, clair

H 190, Ø 130, Base: Ø 120

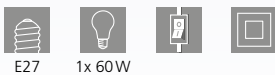

E27 1x 60W



9 002759 948993

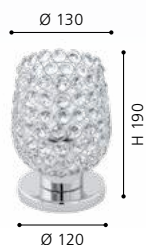

**94897 BONARES 1**

pendant light; steel, chrome / steel, crystal, chrome, clear  
Hängeleuchte; Stahl, chrom / Stahl, Kristall, chrom, klar  
luminaire en suspension; acier, chrome / acier, cristal, chrome, clair

L 745, B 130, H 1100



E27 3x 60W



9 002759 948979



**94898 BONARES 1**

pendant light; steel, chrome / steel, crystal, chrome, clear  
Hängeleuchte; Stahl, chrom / Stahl, Kristall, chrom, klar  
luminaire en suspension; acier, chrome / acier, cristal, chrome, clair

H 1500, Ø 350



E27 5x 60W



9 002759 948986







**98384**



DESIGN  
HIGHLIGHT  
DETAIL

### 98384 BELESER

pendant light; steel, black / glass vaporized, black-transparent  
Hängeleuchte; Stahl, schwarz / Glas bedampft, schwarz-transparent

luminaire en suspension; acier, noir / verre vaporisé, noir transparent

L 905, B 205, H 1100



E27



3x 60W



9 002759 983840





98385



BELESER



98386



98387

### 98385 BELESER

wall light; steel, black / glass vaporized, black-transparent  
Wandleuchte; Stahl, schwarz / Glas bedampft, schwarz-transparent  
applique; acier, noir / verre vaporisé, noir transparent

L 205, H 270, A 255



E27 1x 60W



### 98386 BELESER

table light; steel, black / glass vaporized, black-transparent  
Tischleuchte; Stahl, schwarz / Glas bedampft, schwarz-transparent  
luminaire de table; acier, noir / verre vaporisé, noir transparent

L 265, B 205, H 505, Base: Ø 200

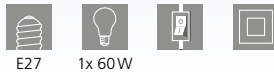

E27 1x 60W



### 98387 BELESER

floor light; steel, black / glass vaporized, black-transparent  
Stehleuchte; Stahl, schwarz / Glas bedampft, schwarz-transparent  
lampadaire; acier, noir / verre vaporisé, noir transparent

L 260, B 205, H 1505, Base: Ø 220

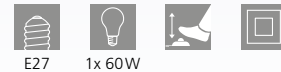

E27 1x 60W





99631



99632



DESIGN  
HIGHLIGHT  
DETAIL



33984

### 99631 GOROSIBA 1

ceiling light; steel, black / glass vaporized, black-transparent  
Deckenleuchte; Stahl, schwarz / Glas bedampft, schwarz-transparent  
plafonnier; acier, noir / verre vaporisé, noir transparent

H 175, Ø 450



E27 3x 40W

### 99632 GOROSIBA 1

ceiling light; steel, black / glass vaporized, black-transparent  
Deckenleuchte; Stahl, schwarz / Glas bedampft, schwarz-transparent  
plafonnier; acier, noir / verre vaporisé, noir transparent

L 380, B 380, H 170



E27 4x 40W

### 33984 GOROSIBA

table light; steel, black / glass vaporized, black-transparent  
Tischleuchte; Stahl, schwarz / Glas bedampft, schwarz-transparent  
luminaire de table; acier, noir / verre vaporisé, noir transparent

H 220, Ø 150, Base: Ø 100

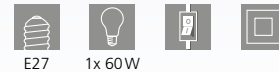

E27 1x 60W



9 002759 996314



9 002759 996321



9 002759 339845





98752



98752

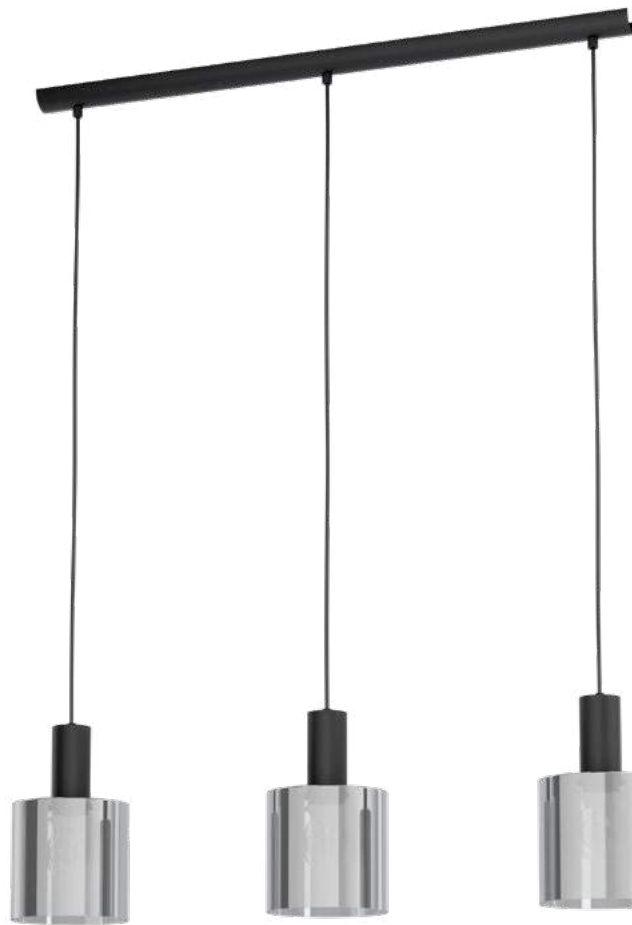

98753



98753 | 98754



98754

### 98752 GOROSIBA

pendant light; steel, black / glass vaporized, black-transparent  
 Hängeleuchte; Stahl, schwarz / Glas bedampft, schwarz-transparent  
 luminaire en suspension; acier, noir / verre vaporisé, noir transparent

H 1100, Ø 150

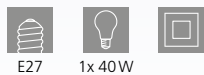

E27 1x 40W



9 002759 987527



Ø 150

### 98753 GOROSIBA

pendant light; steel, black / glass vaporized, black-transparent  
 Hängeleuchte; Stahl, schwarz / Glas bedampft, schwarz-transparent  
 luminaire en suspension; acier, noir / verre vaporisé, noir transparent

L 850, B 150, H 1100



E27 3x 40W



9 002759 987534



L 850

### 98754 GOROSIBA

pendant light; steel, black / glass vaporized, black-transparent  
 Hängeleuchte; Stahl, schwarz / Glas bedampft, schwarz-transparent  
 luminaire en suspension; acier, noir / verre vaporisé, noir transparent

H 1300, Ø 410



E27 3x 40W



9 002759 987541

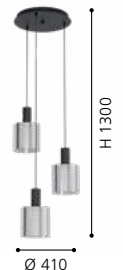

Ø 410



**99371**

**99372**

**99374**

### 99371 MANTUNALLE 1

pendant light; steel, black / glass vaporized, black-transparent  
Hängeleuchte; Stahl, schwarz / Glas bedampft, schwarz-transparent  
luminaire en suspension; acier, noir / verre vaporisé, noir transparent

H 1100, Ø 200

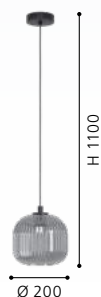

### 99372 MANTUNALLE 1

pendant light; steel, black / glass vaporized, black-transparent  
Hängeleuchte; Stahl, schwarz / Glas bedampft, schwarz-transparent  
luminaire en suspension; acier, noir / verre vaporisé, noir transparent

L 1200, B 200, H 1100



### 99374 MANTUNALLE 1

table light; steel, black / glass vaporized, black-transparent  
Tischleuchte; Stahl, schwarz / Glas bedampft, schwarz-transparent  
luminaire de table; acier, noir / verre vaporisé, noir transparent

H 400, Ø 200, Base: Ø 220







99373

DESIGN  
HIGHLIGHT  
DETAIL



### 99373 MANTUNALLE 1

pendant light; steel, black / glass vaporized, black-transparent  
Hängeleuchte; Stahl, schwarz / Glas bedampft, schwarz-transparent  
luminaire en suspension; acier, noir / verre vaporisé, noir transparent

H 1100, Ø 620



E27



3x 40W



9 002759 993733





### 99366 MANTUNALLE

pendant light; steel, black / glass, white  
 Hängeleuchte; Stahl, schwarz / Glas, weiss  
 luminaire en suspension; acier, noir / verre, blanc

H 1100, Ø 200

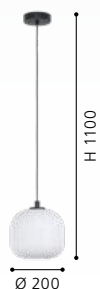

### 99367 MANTUNALLE

pendant light; steel, black / glass, white  
 Hängeleuchte; Stahl, schwarz / Glas, weiss  
 luminaire en suspension; acier, noir / verre, blanc

L 1200, B 200, H 1100

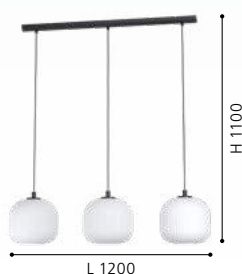

### 99368 MANTUNALLE

pendant light; steel, black / glass, white  
 Hängeleuchte; Stahl, schwarz / Glas, weiss  
 luminaire en suspension; acier, noir / verre, blanc

H 1100, Ø 620





**99368**



EGLO  
RECOMMENDS  
**11595**

99367 | 99368 | 99369



**99369**

### 99369 MANTUNALLE

table light; steel, black / glass, white  
Tischleuchte; Stahl, schwarz / Glas, weiss  
luminaire de table; acier, noir / verre, blanc

H 400, Ø 200, Base: Ø 220



E27 1x 40W



9 002759 993696



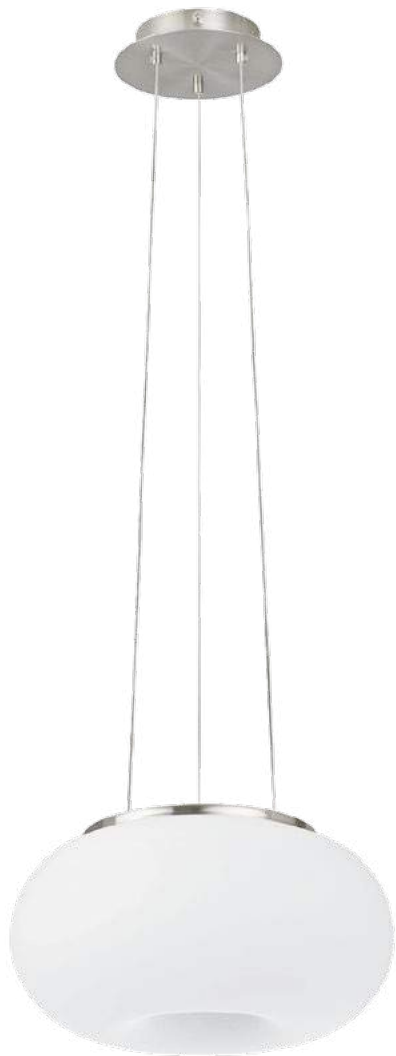

86813



86814



86813 | 86814 | 86815

### 86813 OPTICA

pendant light; steel, satin nickel / glass opal-matt, white  
 Hängeleuchte; Stahl, nickel-matt / Glas opal-matt, weiss  
 luminaire en suspension; acier, nickel mat / verre opale mat, blanc

H 1100, Ø 280



9 002759 868130

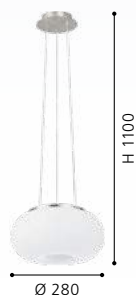

### 86814 OPTICA

pendant light; steel, satin nickel / glass opal-matt, white  
 Hängeleuchte; Stahl, nickel-matt / Glas opal-matt, weiss  
 luminaire en suspension; acier, nickel mat / verre opale mat, blanc

H 1100, Ø 350



9 002759 868147



### 86815 OPTICA

pendant light; steel, satin nickel / glass opal-matt, white  
 Hängeleuchte; Stahl, nickel-matt / Glas opal-matt, weiss  
 luminaire en suspension; acier, nickel mat / verre opale mat, blanc

H 1100, Ø 445



9 002759 868154

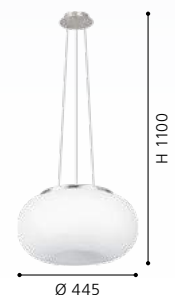



86815





**86811**



**86812**

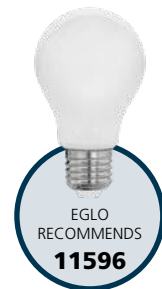

86811 | 86812 | 86816 |  
86817



**86816**

### 86811 OPTICA

wall / ceiling light; steel, satin nickel / glass opal-matt, white  
Wand- / Deckenleuchte; Stahl, nickel-matt / Glas opal-matt, weiss  
applique / plafonnier; acier, nickel mat / verre opale mat, blanc

H 160, Ø 280



### 86812 OPTICA

wall / ceiling light; steel, satin nickel / glass opal-matt, white  
Wand- / Deckenleuchte; Stahl, nickel-matt / Glas opal-matt, weiss  
applique / plafonnier; acier, nickel mat / verre opale mat, blanc

H 210, Ø 350



### 86816 OPTICA

table light; steel, satin nickel / glass opal-matt, white  
Tischleuchte; Stahl, nickel-matt / Glas opal-matt, weiss  
luminaire de table; acier, nickel mat / verre opale mat, blanc

H 460, Ø 280

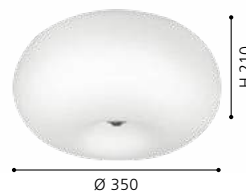
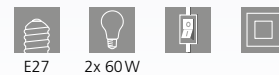



### 86817 OPTICA

floor light; steel, satin nickel / glass opal-matt, white  
Stehleuchte; Stahl, nickel-matt / Glas opal-matt, weiss  
lampadaire; acier, nickel mat / verre opale mat, blanc

H 1570, Ø 350



E27



2x 60W



9 002759 868178

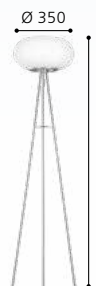

86817



85261



85262

### 85261 RONDO

pendant light; steel, satin nickel / glass opal-matt, white  
 Hängeleuchte; Stahl, nickel-matt / Glas opal-matt, weiss  
 luminaire en suspension; acier, nickel mat / verre opale mat, blanc

H 1100, Ø 200



9 002759 852610



### 85262 RONDO

pendant light; steel, satin nickel / glass opal-matt, white  
 Hängeleuchte; Stahl, nickel-matt / Glas opal-matt, weiss  
 luminaire en suspension; acier, nickel mat / verre opale mat, blanc

H 1100, Ø 250



9 002759 852627





85263



91589



85264



EGLO  
RECOMMENDS  
**11596**

RONDO

### 85263 RONDO

pendant light; steel, satin nickel / glass opal-matt, white  
Hängeleuchte; Stahl, nickel-matt / Glas opal-matt, weiss  
luminaire en suspension; acier, nickel mat / verre opale mat, blanc

H 1100, Ø 300



E27 1x 60W



9 002759 852634



### 91589 RONDO

ceiling light; steel, satin nickel / glass opal-matt, white  
Deckenleuchte; Stahl, nickel-matt / Glas opal-matt, weiss  
plafonnier; acier, nickel mat / verre opale mat, blanc

H 315, Ø 250



E27 1x 60W



9 002759 915896

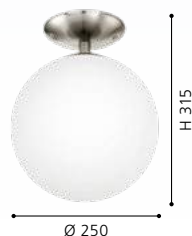

### 85264 RONDO

table light; plastic, white / glass opal-matt, white  
Tischleuchte; Kunststoff, weiss / Glas opal-matt, weiss  
luminaire de table; plastique, blanc / verre opale mat, blanc

H 200, Ø 200

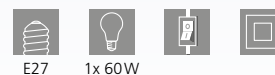

E27 1x 60W



9 002759 852641



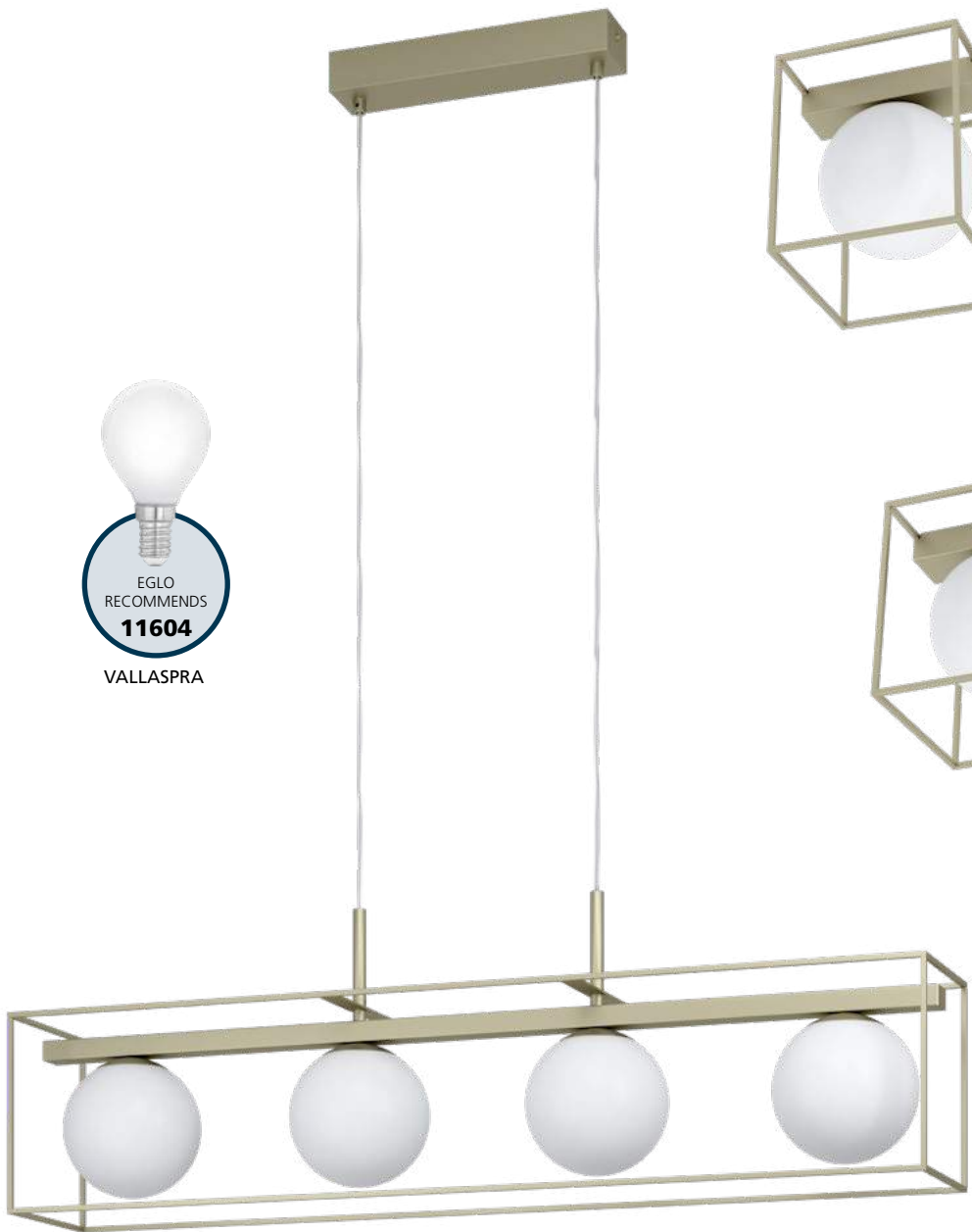

**97791**



**97792**

**97793**

### 97793 VALLASPRA

pendant light; steel, champagne / glass opal-matt, white  
Hängeleuchte; Stahl, champagner / Glas opal-matt, weiss  
luminaire en suspension; acier, champagne / verre opale mat, blanc

L 910, B 165, H 1100



9 002759 977931

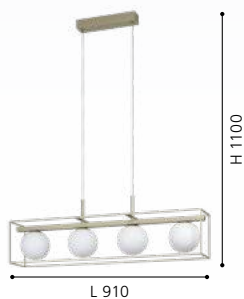

### 97791 VALLASPRA

wall / ceiling light; steel, champagne / glass opal-matt, white  
Wand- / Deckenleuchte; Stahl, champagner / Glas opal-matt, weiss  
applique / plafonnier; acier, champagne / verre opale mat, blanc

L 165, B 165, H 190



9 002759 977917

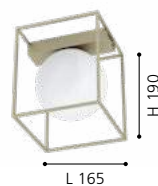

### 97792 VALLASPRA

wall / ceiling light; steel, champagne / glass opal-matt, white  
Wand- / Deckenleuchte; Stahl, champagner / Glas opal-matt, weiss  
applique / plafonnier; acier, champagne / verre opale mat, blanc

L 350, B 165, H 190



9 002759 977924







### 97794 VALLASPRA

table light; steel, champagne / glass opal-matt, white  
Tischleuchte; Stahl, champagner / Glas opal-matt, weiss  
luminaire de table; acier, champagne / verre opale mat, blanc

L 165, B 165, H 190



E14



1x 40W

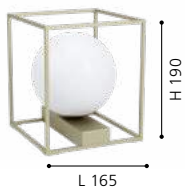

97794



### 99288 PINTO TEXTIL

wall light; steel, satin nickel / glass, fabric, clear, grey  
 Wandleuchte; Stahl, nickel-matt / Glas, Textil, klar, grau  
 applique; acier, nickel mat / verre, tissu, clair, gris

L 120, H 445, A 180



9 002759 992880



### 99285 PINTO TEXTIL

pendant light; steel, satin nickel / glass, fabric, clear, grey  
 Hängeleuchte; Stahl, nickel-matt / Glas, Textil, klar, grau  
 luminaire en suspension; acier, nickel mat / verre, tissu, clair, gris

H 1100, Ø 120



9 002759 992859



### 99286 PINTO TEXTIL

pendant light; steel, satin nickel / glass, fabric, clear, grey  
 Hängeleuchte; Stahl, nickel-matt / Glas, Textil, klar, grau  
 luminaire en suspension; acier, nickel mat / verre, tissu, clair, gris

L 820, B 120, H 1100



9 002759 992866





99286 | 99287



### 99287 PINTO TEXTIL

pendant light; steel, satin nickel / glass, fabric, clear, grey  
 Hängeleuchte; Stahl, nickel-matt / Glas, Textil, klar, grau  
 luminaire en suspension; acier, nickel mat / verre, tissu, clair, gris

L 945, B 120, H 1100





DESIGN  
HIGHLIGHT  
DETAIL



90304

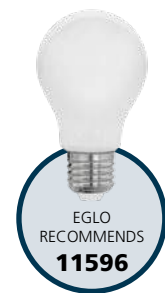

90304 | 90305

### 90304 PINTO NERO

pendant light; steel, satin nickel / smoked glass, glass opal-matt, black-transparent, white

Hängeleuchte; Stahl, nickel-matt / Rauchglas, Glas opal-matt, schwarz-transparent, weiss

luminaire en suspension; acier, nickel mat / verre fumé, verre opale mat, noir transparent, blanc

H 1100, Ø 110



E27



1x 40W



9 002759 903046



### 90305 PINTO NERO

pendant light; steel, satin nickel / smoked glass, glass opal-matt, black-transparent, white

Hängeleuchte; Stahl, nickel-matt / Rauchglas, Glas opal-matt, schwarz-transparent, weiss

luminaire en suspension; acier, nickel mat / verre fumé, verre opale mat, noir transparent, blanc

L 725, H 1100



E27



3x 40W



9 002759 903053

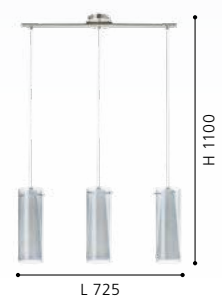



90305





### 97653 PINTO GOLD

pendant light; steel, black / glass, clear, gold  
 Hängeleuchte; Stahl, schwarz / Glas, klar, gold  
 luminaire en suspension; acier, noir / verre, clair, or

L 905, B 360, H 1100



E27 4x 40W

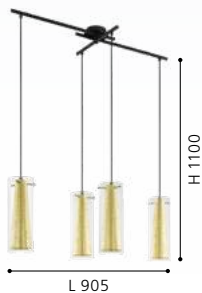

9 002759 976538

### 97651 PINTO GOLD

pendant light; steel, black / glass, clear, gold  
 Hängeleuchte; Stahl, schwarz / Glas, klar, gold  
 luminaire en suspension; acier, noir / verre, clair, or

H 1100, Ø 110



E27 1x 40W



9 002759 976514

### 97839 PINTO GOLD

wall light; steel, black / glass, clear, gold  
 Wandleuchte; Stahl, schwarz / Glas, klar, gold  
 applique; acier, noir / verre, clair, or

L 110, H 270, A 150



E27 1x 40W



9 002759 978396



**97652**



**97655**



PINTO GOLD



**97652 PINTO GOLD**

pendant light; steel, black / glass, clear, gold  
 Hängeleuchte; Stahl, schwarz / Glas, klar, gold  
 luminaire en suspension; acier, noir / verre, clair, or

L 725, B 110, H 1100



9 002759 976521

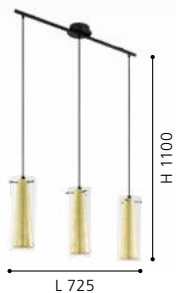

**97655 PINTO GOLD**

floor light; steel, black, gold / glass, clear, gold  
 Stehleuchte; Stahl, schwarz, gold / Glas, klar, gold  
 lampadaire; acier, noir, or / verre, clair, or

H 1470, Ø 110, Base: Ø 230



9 002759 976552

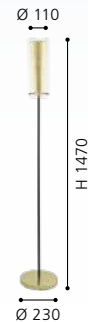

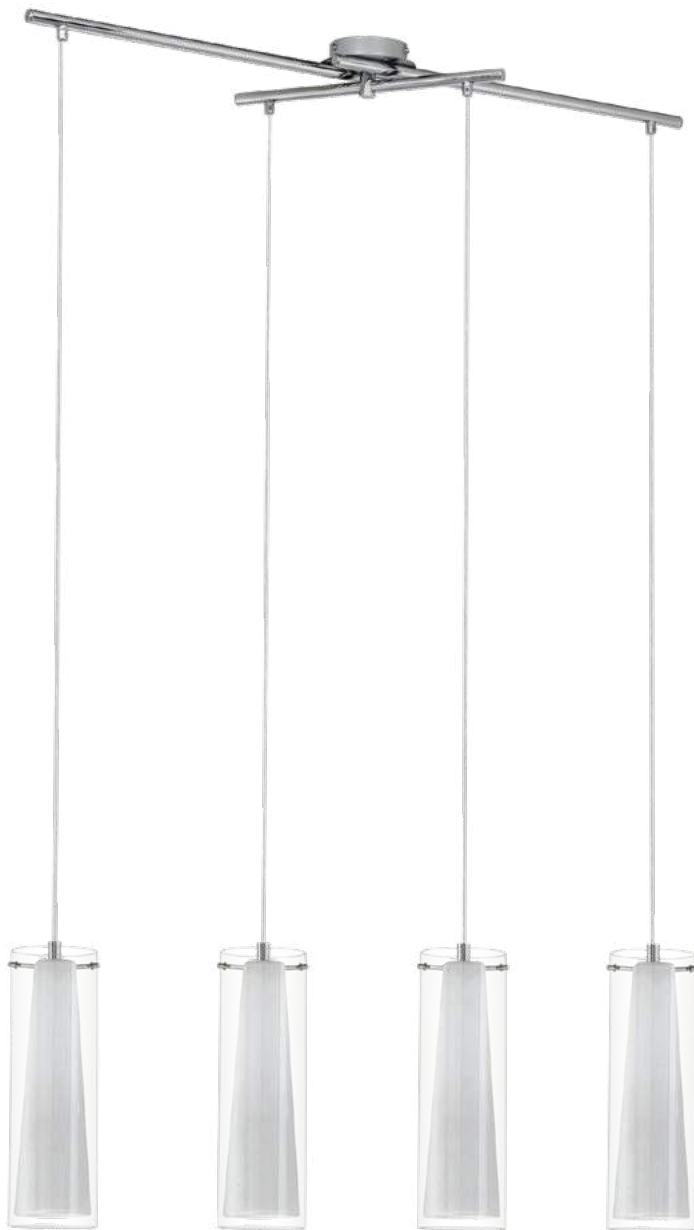

**89834**



89832 | 89833 | 89834 |  
89835 | 89836



**89832**



**89835**

### 89834 PINTO

pendant light; steel, chrome / glass, glass opal-matt, clear, white  
Hängeleuchte; Stahl, chrom / Glas, Glas opal-matt, klar, weiss  
luminaire en suspension; acier, chrome / verre, verre opale mat, clair, blanc

L 905, B 360, H 1100



E27 4x 40W



9 002759 898342

### 89835 PINTO

table light; steel, chrome / glass, glass opal-matt, clear, white  
Tischleuchte; Stahl, chrom / Glas, Glas opal-matt, klar, weiss  
luminaire de table; acier, chrome / verre, verre opale mat, clair, blanc

H 500, Ø 110, Base: Ø 155



E27 1x 40W



9 002759 898359

### 89832 PINTO

pendant light; steel, chrome / glass, glass opal-matt, clear, white  
Hängeleuchte; Stahl, chrom / Glas, Glas opal-matt, klar, weiss  
luminaire en suspension; acier, chrome / verre, verre opale mat, clair, blanc

H 1100, Ø 110



E27 1x 40W



9 002759 898328



**93003**



**89833**



**89836**

### 93003 PINTO

pendant light; steel, chrome / glass, glass opal-matt, clear, white  
 Hängeleuchte; Stahl, chrom / Glas, Glas opal-matt, klar, weiss  
 luminaire en suspension; acier, chrome / verre, verre opale mat, clair, blanc

H 1500, Ø 500



E27 5x 40W



9 002759 930035



### 89833 PINTO

pendant light; steel, chrome / glass, glass opal-matt, clear, white  
 Hängeleuchte; Stahl, chrom / Glas, Glas opal-matt, klar, weiss  
 luminaire en suspension; acier, chrome / verre, verre opale mat, clair, blanc

L 725, H 1100



E27 3x 40W



9 002759 898335



### 89836 PINTO

floor light; steel, chrome / glass, glass opal-matt, clear, white  
 Stehleuchte; Stahl, chrom / Glas, Glas opal-matt, klar, weiss  
 lampadaire; acier, chrome / verre, verre opale mat, clair, blanc

H 1470, Ø 110, Base: Ø 230

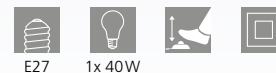

E27 1x 40W



9 002759 898366

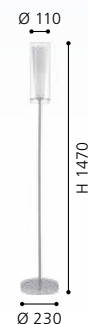



**85978**



**85977**

**85978 TROY 3**

pendant light; steel, satin nickel / satin glass, white painted  
 Hängeleuchte; Stahl, nickel-matt / Glas satiniert, weiss lackiert  
 luminaire en suspension; acier, nickel mat / verre satiné, blanc laqué

L 720, B 105, H 1100



E27



3x 40W



9 002759 859787

**85977 TROY 3**

pendant light; steel, satin nickel / satin glass, white painted  
 Hängeleuchte; Stahl, nickel-matt / Glas satiniert, weiss lackiert  
 luminaire en suspension; acier, nickel mat / verre satiné, blanc laqué

H 1100, Ø 110



E27



1x 40W



9 002759 859770

**85979 TROY 3**

wall light; steel, satin nickel / satin glass, white  
 Wandleuchte; Stahl, nickel-matt / Glas satiniert, weiss  
 applique; acier, nickel mat / verre satiné, blanc laqué

L 180, H 250, A 75



E14



1x 60W



9 002759 859794





**85979**



85979



**85981**



85977 | 85978 | 85981 |  
85982

### 85981 TROY 3

table light; steel, satin nickel / satin glass, white painted  
Tischleuchte; Stahl, nickel-matt / Glas satiniert, weiss lackiert  
luminaire de table; acier, nickel mat / verre satiné, blanc laqué

H 460, Ø 105, Base: Ø 120



E27 1x 40W



9 002759 859817



### 85982 TROY 3

floor light; steel, satin nickel / satin glass, white painted  
Stehleuchte; Stahl, nickel-matt / Glas satiniert, weiss lackiert  
lampadaire; acier, nickel mat / verre satiné, blanc laqué

H 1530, Ø 105, Base: Ø 200



E27 1x 40W



9 002759 859824

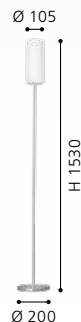

**85982**



92739



EGLO  
RECOMMENDS  
**11602**

92742

92742

92741

### 92739 RIVATO

pendant light; steel, chrome / glass with decor, white, chrome  
Hängeleuchte; Stahl, chrom / Glas mit Dekor, weiss, chrom  
luminaire en suspension; acier, chrome / verre avec décor, blanc, chrome

H 1100, Ø 90



E27

1x 60W



9 002759 927394

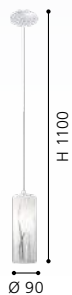

### 92741 RIVATO

pendant light; steel, chrome / glass with decor, white, chrome  
Hängeleuchte; Stahl, chrom / Glas mit Dekor, weiss, chrom  
luminaire en suspension; acier, chrome / verre avec décor, blanc, chrome

L 705, B 90, H 1100



E27

3x 60W



9 002759 927417



### 92742 RIVATO

wall light; steel, white, chrome / glass with decor, white, chrome  
Wandleuchte; Stahl, weiss, chrom / Glas mit Dekor, weiss, chrom  
applique; acier, blanc, chrome / verre avec décor, blanc, chrome

L 180, H 250, A 80



E14

1x 42W



9 002759 927424





91971 | 92563 | 92739 |  
92741 | 92743



**92743**



**92563**

**91971**

### 92743 RIVATO

table light; glass with decor, white, chrome  
Tischleuchte; Glas mit Dekor, weiss, chrom  
luminaire de table; verre avec décor, blanc, chrome

H 260, Ø 90

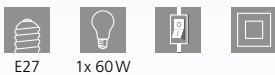

9 002759 927431



### 92563 BAYMAN

pendant light; steel, chrome / glass with decor, white, chrome  
Hängeleuchte; Stahl, chrom / Glas mit Dekor, weiss, chrom  
luminaire en suspension; acier, chrome / verre avec décor, blanc, chrome

L 720, B 105, H 1100



9 002759 925635



### 91971 BAYMAN

table light; glass with decor, white, chrome  
Tischleuchte; Glas mit Dekor, weiss, chrom  
luminaire de table; verre avec décor, blanc, chrome

H 270, Ø 105

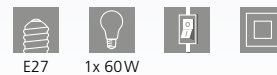

9 002759 919719





**90048**



**90049**



90049

### 90048 AMADORA

pendant light; steel, satin nickel / glass printed, white  
 Hängeleuchte; Stahl, nickel-matt / Glas bedruckt, weiss  
 luminaire en suspension; acier, nickel mat / verre imprimé, blanc

L 720, B 105, H 1100



### 90049 AMADORA

wall light; steel, satin nickel / glass printed, white  
 Wandleuchte; Stahl, nickel-matt / Glas bedruckt, weiss  
 applique; acier, nickel mat / verre imprimé, blanc

L 180, H 250, A 75





**97587**



**97589**



90048 | 97587 | 97589

### BATISTA 3

These luminaires come with a hand-made glass with a special wipe technique.

Diese Leuchten sind aus handgemachtem Glas mit spezieller Wischtechnik.

Ces luminaires viennent avec un verre de luxe fait main avec une technique à l'essuyé.



### 97587 BATISTA 3

pendant light; steel, satin nickel / glass wiping technique, white  
Hängeleuchte; Stahl, nickel-matt / Glas Wischtechnik, weiss  
luminaire en suspension; acier, nickel mat / technique d'essuie de verre, blanc

L 1020, B 120, H 1100



9 002759 975876



### 97589 BATISTA 3

table light; steel, satin nickel / glass wiping technique, white  
Tischleuchte; Stahl, nickel-matt / Glas Wischtechnik, weiss  
luminaire de table; acier, nickel mat / technique d'essuie de verre, blanc

H 225, Ø 120, Base: Ø 110



9 002759 975890







91433



91002



91004

### 91433 VINOVO

pendant light; steel, dark brown / glass alabaster, white  
 Hängeleuchte; Stahl, dunkelbraun / Glas alabaster, weiss  
 luminaire en suspension; acier, marron foncé / verre albâtre, blanc

L 770, B 250, H 1100



E27

2x 60W



9 002759 914332



L 770

H 1100

### 91002 MURCIA

pendant light; steel, black / glass alabaster, white  
 Hängeleuchte; Stahl, schwarz / Glas alabaster, weiss  
 luminaire en suspension; acier, noir / verre albâtre, blanc

H 1100, Ø 380



E27

1x 60W



9 002759 910020



Ø 380

H 1100

### 91004 MURCIA

pendant light; steel, black / glass alabaster, white  
 Hängeleuchte; Stahl, schwarz / Glas alabaster, weiss  
 luminaire en suspension; acier, noir / verre albâtre, blanc

L 680, H 1100



E27

2x 60W



9 002759 910044

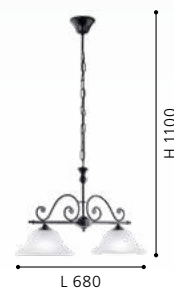

L 680

H 1100



91005



91006



91007



### MURCIA, VINOVO

These luminaires come with high quality processed alabaster glass.

Diese Leuchten sind mit hochwertigem Alabasterglas ausgestattet.

Ces luminaires viennent avec un abat-jour en verre d'albâtre haut de gamme.

### 91005 MURCIA

pendant light; steel, black / glass alabaster, white  
Hängeleuchte; Stahl, schwarz / Glas alabaster, weiss  
luminaire en suspension; acier, noir / verre albâtre, blanc

H 1100, Ø 630



E27 3x 60W



9 002759 910051

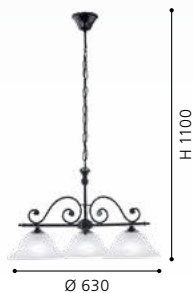

### 91006 MURCIA

wall light; steel, black / glass alabaster, white  
Wandleuchte; Stahl, schwarz / Glas alabaster, weiss  
applique; acier, noir / verre albâtre, blanc

L 165, H 190, A 230



E14 1x 40W



9 002759 910068



### 91007 MURCIA

table light; steel, black / glass alabaster, white  
Tischleuchte; Stahl, schwarz / Glas alabaster, weiss  
luminaire de table; acier, noir / verre albâtre, blanc

L 165, H 370, Base: Ø 150



E14 1x 40W



9 002759 910075





**82748**



**82749**



DESIGN  
HIGHLIGHT  
DETAIL

**82748 SAVOY**

pendant light; cast metal, bronzed / satin glass, white  
Hängeleuchte; Metallguss, brüniert / Glas satiniert, weiss  
luminaire en suspension; fonte métallique, bruni / verre satiné, blanc

H 1100, Ø 740

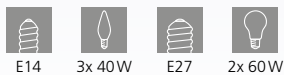

**82749 SAVOY**

pendant light; cast metal, bronzed / satin glass, white  
Hängeleuchte; Metallguss, brüniert / Glas satiniert, weiss  
luminaire en suspension; fonte métallique, bruni / verre satiné, blanc

H 1100, Ø 740





82751



82752



82747

### 82751 SAVOY

wall light; cast metal, bronzed / satin glass, white  
Wandleuchte; Metallguss, brüniert / Glas satiniert, weiss  
applique; fonte métallique, bruni / verre satiné, blanc

L 180, H 160, A 240



E14 1x 40W



9 002759 827519



### 82752 SAVOY

wall light; cast metal, bronzed / satin glass, white  
Wandleuchte; Metallguss, brüniert / Glas satiniert, weiss  
applique; fonte métallique, bruni / verre satiné, blanc

L 410, H 160, A 210



E14 2x 40W



9 002759 827526

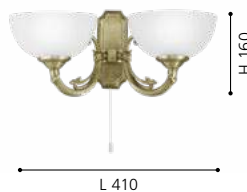

### 82747 SAVOY

pendant light; cast metal, bronzed / satin glass, white  
Hängeleuchte; Metallguss, brüniert / Glas satiniert, weiss  
luminaire en suspension; fonte métallique, bruni / verre satiné, blanc

H 1100, Ø 310



E27 2x 60W



9 002759 827472

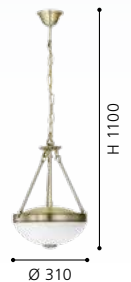



85856



85857



85859

### 85856 MARBELLA

ceiling light; cast metal, bronzed / glass alabaster, champagne  
Deckenleuchte; Metallguss, brüniert / Glas alabaster, champagner  
plafonnier; fonte métallique, bruni / verre albâtre, champagne

H 410, Ø 370



E14 3x 60W



9 002759 858568

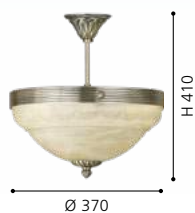

### 85857 MARBELLA

pendant light; cast metal, bronzed / glass alabaster, champagne  
Hängeleuchte; Metallguss, brüniert / Glas alabaster, champagner  
luminaire en suspension; fonte métallique, bruni / verre albâtre, champagne

H 1100, Ø 740



E14 6x 60W



9 002759 858575



### 85859 MARBELLA

wall light; cast metal, bronzed / glass alabaster, champagne  
Wandleuchte; Metallguss, brüniert / Glas alabaster, champagner  
applique; fonte métallique, bruni / verre albâtre, champagne

L 170, H 200, A 230

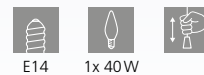

E14 1x 40W



9 002759 858599







85858

### 85858 MARBELLA

pendant light; cast metal, bronzed / glass alabaster, champagne  
Hängeleuchte; Metallguss, brüniert / Glas alabaster, champagner  
luminaire en suspension; fonte métallique, bruni / verre albâtre, champagne

H 1100, Ø 740



### MARBELLA

These luminaires come with high quality processed alabaster glass.

Diese Leuchten sind mit hochwertigem Alabasterglas ausgestattet.

Ces luminaires viennent avec un abat-jour en verre d'albâtre haut de gamme.





### 98876 ERVIDEL

pendant light; steel, black / plastic, satined, clear  
 Hängeleuchte; Stahl, schwarz / Kunststoff, satiniert, klar  
 luminaire en suspension; acier, noir / plastique, satiné, clair

L 930, B 60, H 1100



6x 4,5W 2880lm

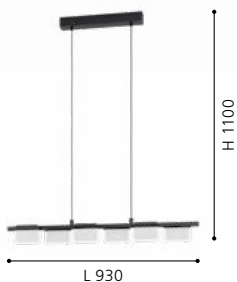

### 98874 ERVIDEL

ceiling light; steel, black / plastic, satined, clear  
 Deckenleuchte; Stahl, schwarz / Kunststoff, satiniert, klar  
 plafonnier; acier, noir / plastique, satiné, clair

L 625, B 60, H 160



4x 4,5W 1920lm



### 98875 ERVIDEL

ceiling light; steel, black / plastic, satined, clear  
 Deckenleuchte; Stahl, schwarz / Kunststoff, satiniert, klar  
 plafonnier; acier, noir / plastique, satiné, clair

L 930, B 60, H 160



6x 4,5W 2880lm





98878

LED



98877

LED

### 98878 ERVIDEL

table light; steel, black / plastic, satined, clear  
Tischleuchte; Stahl, schwarz / Kunststoff, satiniert, klar  
luminaire de table; acier, noir / plastique, satiné, clair

L 155, B 60, H 500, Base: B 180, T 180



2x 4,5W 960lm



9 002759 988784



### 98877 ERVIDEL

wall light; steel, black / plastic, satined, clear  
Wandleuchte; Stahl, schwarz / Kunststoff, satiniert, klar  
applique; acier, noir / plastique, satiné, clair

L 320, H 90, A 80



2x 4,5W 960lm



9 002759 988777





99562

LED

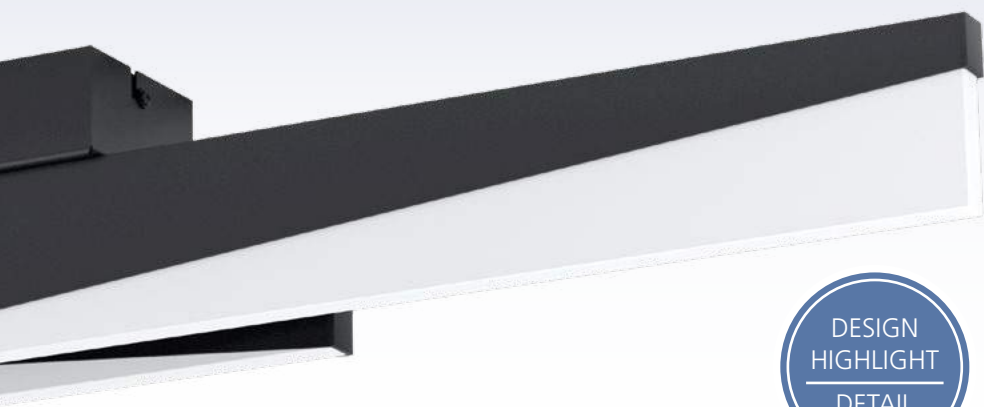

DESIGN  
HIGHLIGHT  
DETAIL

**99562 ISIDRO**

pendant light; aluminium, steel, black / plastic, satined  
Hängeleuchte; Alu, Stahl, schwarz / Kunststoff, satiniert  
luminaire en suspension; aluminium, acier, noir / plastique, satiné

L 795, B 60, H 1100

LED  
27W

warm  
WHITE  
3850lm

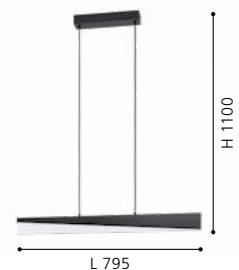





99561



99563

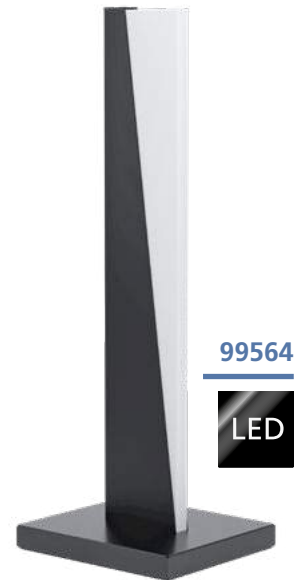

99564



### 99561 ISIDRO

ceiling light; aluminium, steel, black / plastic, satiné  
Deckenleuchte; Alu, Stahl, schwarz / Kunststoff, satiniert  
plafonnier; aluminium, acier, noir / plastique, satiné

L 860, B 80, H 110



2x 11 W 2700lm



9 002759 995614



### 99563 ISIDRO

wall light; aluminium, steel, black / plastic, satiné  
Wandleuchte; Alu, Stahl, schwarz / Kunststoff, satiniert  
applique; aluminium, acier, noir / plastique, satiné

L 395, H 80, A 70



9 W 1050lm



9 002759 995638



### 99564 ISIDRO

table light; aluminium, steel, black / plastic, satiné  
Tischleuchte; Alu, Stahl, schwarz / Kunststoff, satiniert  
luminaire de table; aluminium, acier, noir / plastique, satiné

H 410, Base: B 150, T 130



9 W 1050lm



9 002759 995645







**99013**  
LED

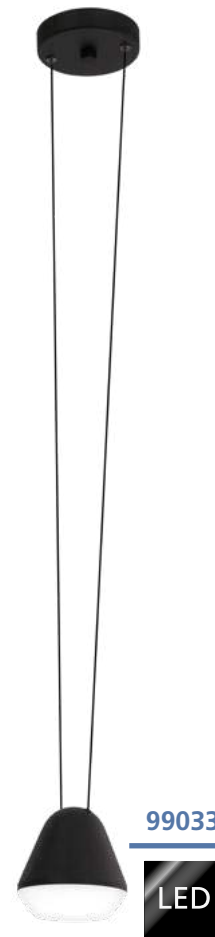

**99033**  
LED



DESIGN  
HIGHLIGHT  
DETAIL

**99013 PALBIETA**

pendant light; steel, black / plastic, clear, satined  
Hängeleuchte; Stahl, schwarz / Kunststoff, klar, satiniert  
luminaire en suspension; acier, noir / plastique, clair, satiné

L 1160, B 115, H 1100

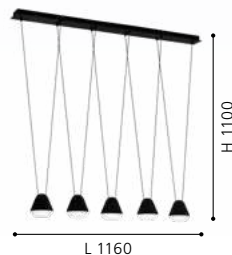
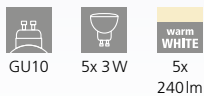

**99033 PALBIETA**

pendant light; steel, black / plastic, clear, satined  
Hängeleuchte; Stahl, schwarz / Kunststoff, klar, satiniert  
luminaire en suspension; acier, noir / plastique, clair, satiné

H 1100, Ø 115

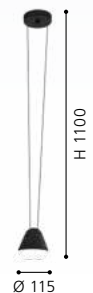
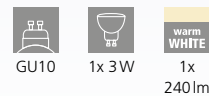



99034

LED

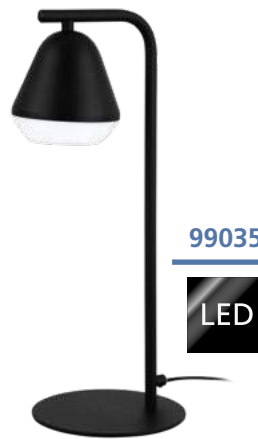

99035

LED

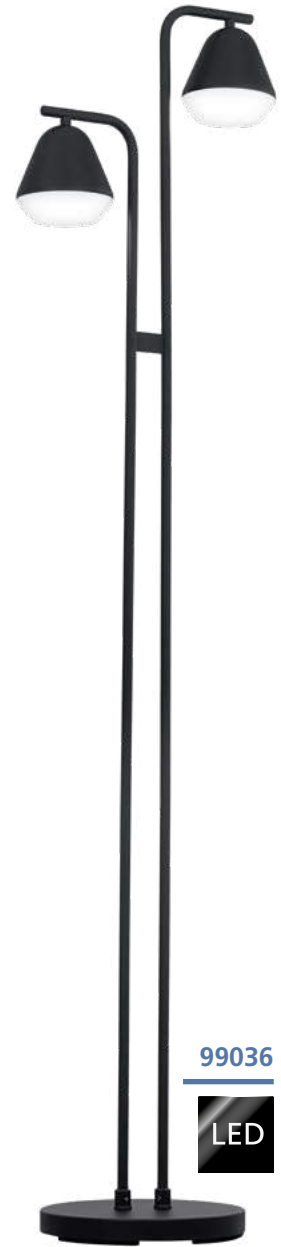

99036

LED

### 99034 PALBIETA

wall light; steel, black / plastic, clear, satiné  
Wandleuchte; Stahl, schwarz / Kunststoff, klar, satiniert  
applique; acier, noir / plastique, clair, satiné

L 115, H 275, A 185

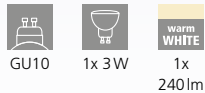

9 002759 990343



### 99035 PALBIETA

table light; steel, black / plastic, clear, satiné  
Tischleuchte; Stahl, schwarz / Kunststoff, klar, satiniert  
luminaire de table; acier, noir / plastique, clair, satiné

L 190, B 170, H 445, Base: Ø 170

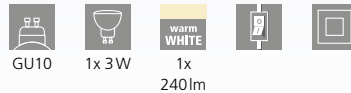

9 002759 990350



### 99036 PALBIETA

floor light; steel, black / plastic, clear, satiné  
Stehleuchte; Stahl, schwarz / Kunststoff, klar, satiniert  
lampadaire; acier, noir / plastique, clair, satiné

L 350, B 250, H 1530, Base: Ø 250

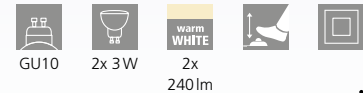

9 002759 990367

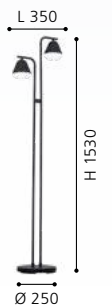



### 99378

This floor luminaire has additional lighting on the backside.

Die Stehleuchte hat zusätzlich an der Rückseite eine Beleuchtung.

Ce lampadaire dispose d'un éclairage supplémentaire à l'arrière.



### 99376

LED

### 99378

LED

### 99376 PHIANEROS

pendant light; steel, black / plastic, black, white  
Hängeleuchte; Stahl, schwarz / Kunststoff, schwarz, weiss  
luminaire en suspension; acier, noir / plastique, noir, blanc

L 1000, H 1200

LED

warm WHITE  
2700lm



9 002759 993764

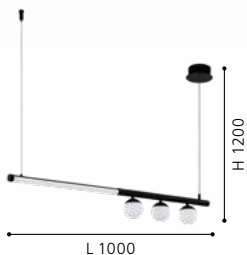

### 99378 PHIANEROS

floor light; steel, black / plastic, black, white  
Stehleuchte; Stahl, schwarz / Kunststoff, schwarz, weiss  
lampadaire; acier, noir / plastique, noir, blanc

H 1400, Ø 200

LED

warm WHITE  
1390lm

LED

warm WHITE  
4W 389lm



9 002759 993788



### 99375 PHIANEROS

ceiling light; steel, black / plastic, black, white  
Deckenleuchte; Stahl, schwarz / Kunststoff, schwarz, weiss  
plafonnier; acier, noir / plastique, noir, blanc

H 120, Ø 400

LED

warm WHITE  
2800lm



9 002759 993757



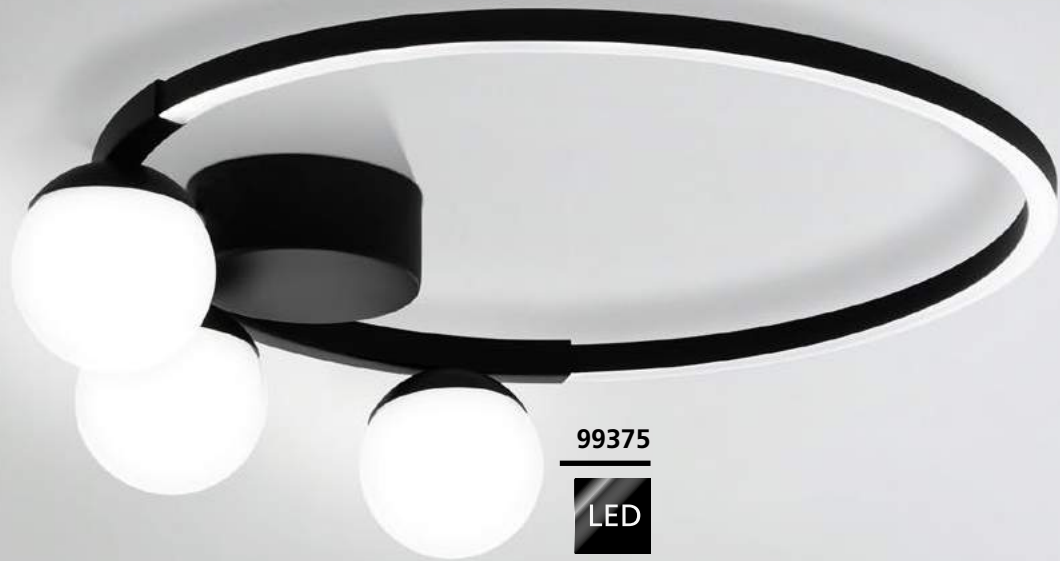

99375

LED

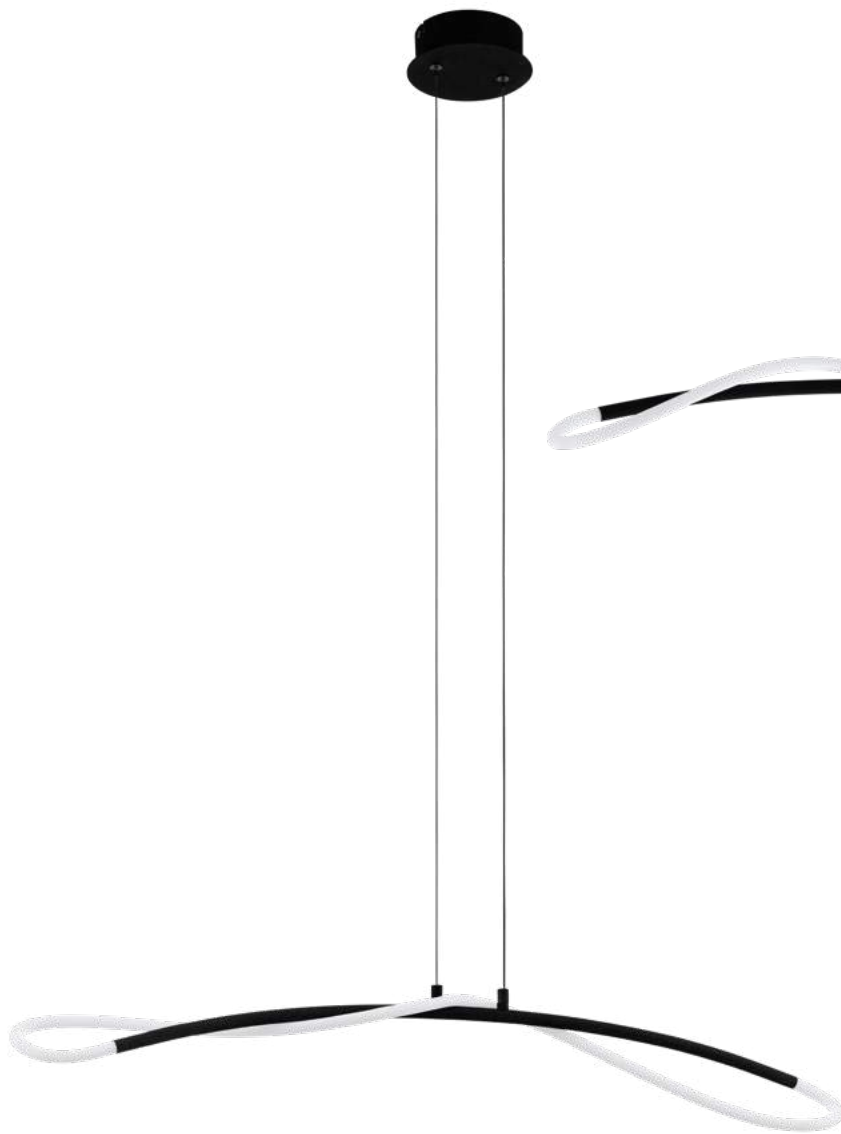

99382



99381



### 99382 EGIDONELLA

pendant light; steel, black / plastic, white  
Hängeleuchte; Stahl, schwarz / Kunststoff, weiss  
luminaire en suspension; acier, noir / plastique, blanc

L 900, B 140, H 1200

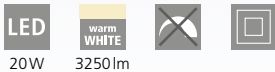

20W 3250lm

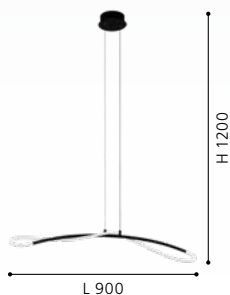

### 99381 EGIDONELLA

ceiling light; steel, black / plastic, white  
Deckenleuchte; Stahl, schwarz / Kunststoff, weiss  
plafonnier; acier, noir / plastique, blanc

L 900, B 140, H 210



20W 3250lm



### 99383 EGIDONELLA

table light; steel, black / plastic, white  
Tischleuchte; Stahl, schwarz / Kunststoff, weiss  
luminaire de table; acier, noir / plastique, blanc

L 355, B 150, H 380, Base: Ø 150



5,5W 700lm

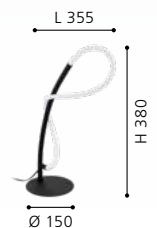





99383

LED

### 99384 EGIDONELLA

floor light; steel, black / plastic, white  
 Stehleuchte; Stahl, schwarz / Kunststoff, weiss  
 lampadaire; acier, noir / plastique, blanc

L 730, H 1600, Base: Ø 250



20,5W



2750lm



L 730



9 002759 993849

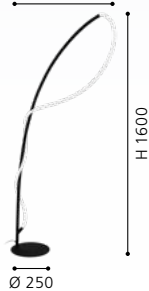

99384

LED



99429

LED



39836

LED

### 39836 BANDERILLAS

ceiling light; steel, black / plastic, white, black  
Deckenleuchte; Stahl, schwarz / Kunststoff, weiss, schwarz  
plafonnier; acier, noir / plastique, blanc, noir

L 1160, B 170, H 200



2x 12W  
2x  
1950lm



9 002759 398361



### 99429 ALAMEDILLA

pendant light; steel, black / plastic, white, black  
Hängeleuchte; Stahl, schwarz / Kunststoff, weiss, schwarz  
luminaire en suspension; acier, noir / plastique, blanc, noir

L 970, B 380, H 1200



27W  
4200lm



9 002759 994297

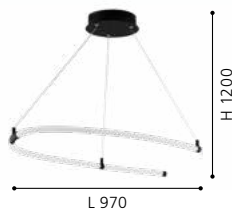

### 39838 BANDERILLAS

table light; plastic, black / plastic, white  
Tischleuchte; Kunststoff, schwarz / Kunststoff, weiss  
luminaire de table; plastique, noir / plastique, blanc

H 300, Ø 195



10W  
1300lm



9 002759 398385

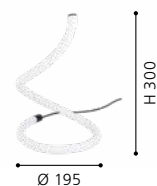



39838

LED



39839

LED

### 39839 BANDERILLAS

pendant light; steel, black / plastic, white, black  
 Hängeleuchte; Stahl, schwarz / Kunststoff, weiss, schwarz  
 luminaire en suspension; acier, noir / plastique, blanc, noir

H 1200, Ø 600

LED	warm WHITE	LED	warm WHITE	
22W	3500lm	14W	2300lm	





### 99799 LEJIAS

ceiling light; steel, black / plastic, transparent  
Deckenleuchte; Stahl, schwarz / Kunststoff, transparent  
plafonnier; acier, noir / plastique, transparent

L 450, B 450, H 75

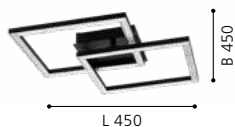

### 99801 LEJIAS

ceiling light; steel, black / plastic, transparent  
Deckenleuchte; Stahl, schwarz / Kunststoff, transparent  
plafonnier; acier, noir / plastique, transparent

L 780, B 80



### 99802 LEJIAS

pendant light; steel, black / plastic, transparent  
Hängeleuchte; Stahl, schwarz / Kunststoff, transparent  
luminaire en suspension; acier, noir / plastique, transparent

L 780, B 80, H 1100

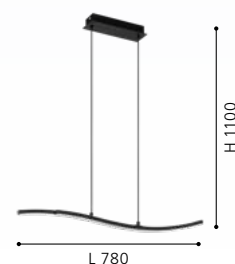

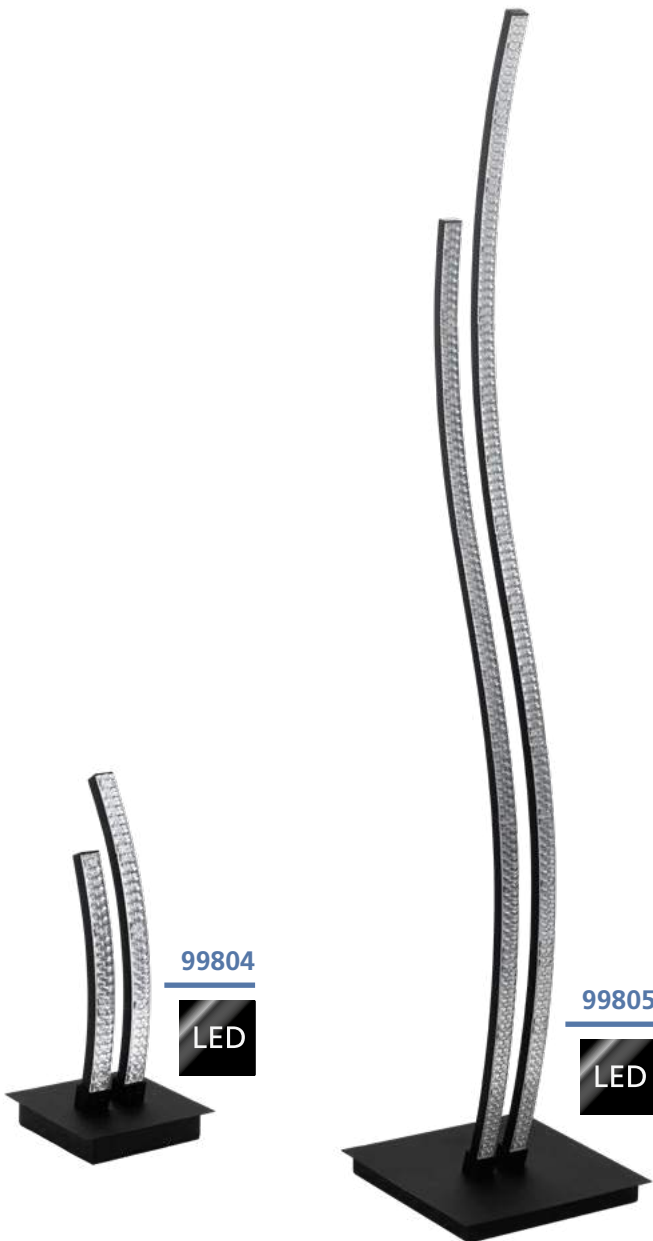

99804

LED

99805

LED



99803

LED

### 99804 LEJIAS

table light; steel, black / plastic, transparent  
Tischleuchte; Stahl, schwarz / Kunststoff, transparent  
luminaire de table; acier, noir / plastique, transparent

H 330, Base: B 140, T 140



8W 1050lm



9 002759 998042



### 99805 LEJIAS

floor light; steel, black / plastic, transparent  
Stehleuchte; Stahl, schwarz / Kunststoff, transparent  
lampadaire; acier, noir / plastique, transparent

H 1230, Base: B 230, T 230



16W 2050lm



9 002759 998059

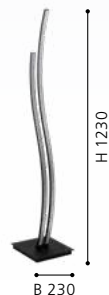

### 99803 LEJIAS

wall light; steel, black / plastic, transparent  
Wandleuchte; Stahl, schwarz / Kunststoff, transparent  
applique; acier, noir / plastique, transparent

L 90, H 285



8W 1050lm



9 002759 998035





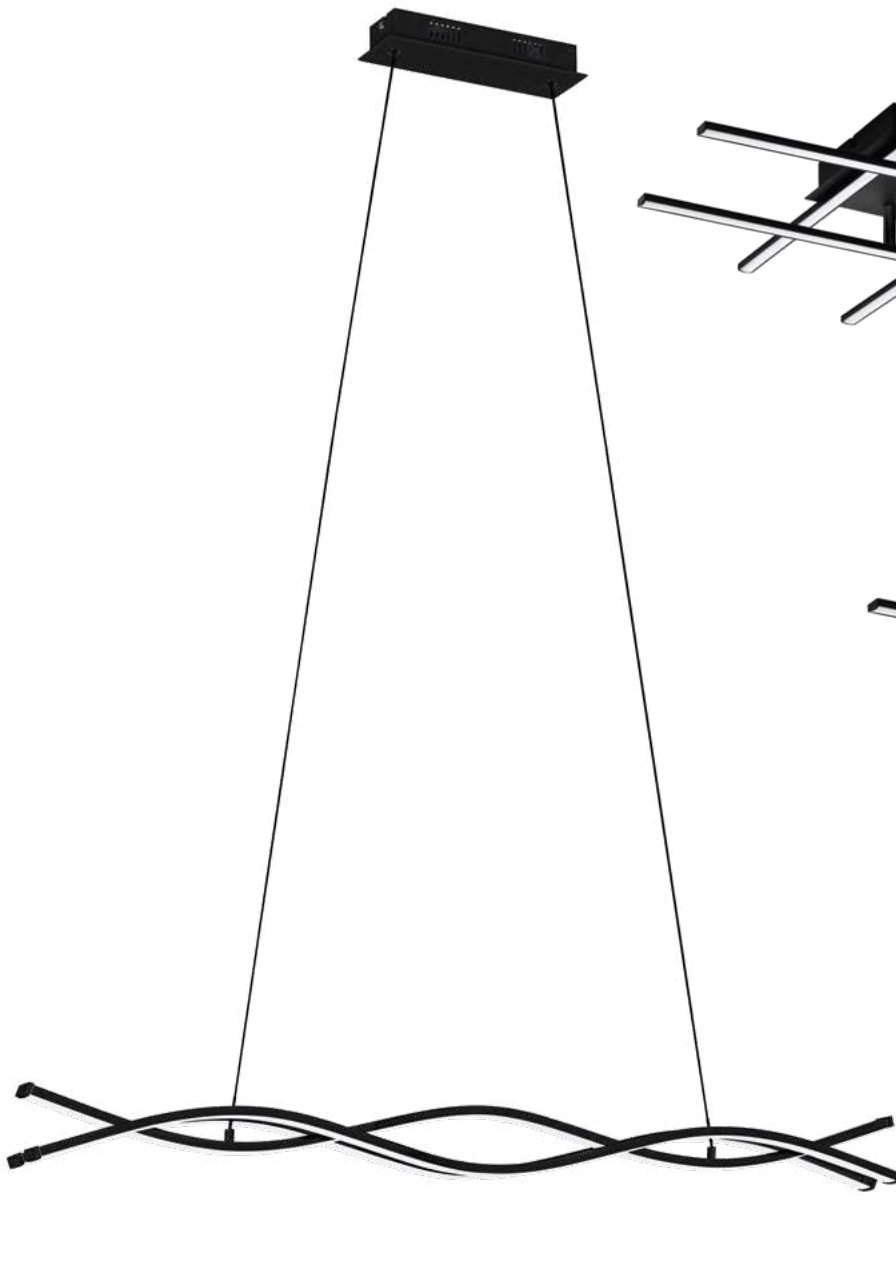

99317

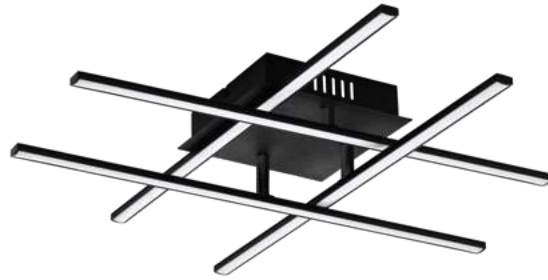

99316



99315



### 99317 LASANA 3

pendant light; steel, aluminium, black / plastic, white  
Hängeleuchte; Stahl, Alu, schwarz / Kunststoff, weiss  
luminaire en suspension; acier, aluminium, noir / plastique, blanc

L 985, B 80, H 1200

LED 36W  
warm WHITE 5300lm

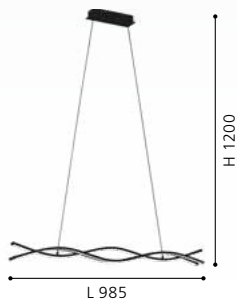

### 99316 LASANA 3

wall / ceiling light; steel, aluminium, black / plastic, white  
Wand- / Deckenleuchte; Stahl, Alu, schwarz / Kunststoff, weiss  
applique / plafonnier; acier, aluminium, noir / plastique, blanc

L 500, B 500, H 95

LED 4x 5,2W  
warm WHITE 4x 740lm

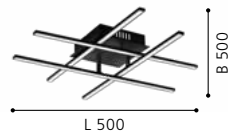

### 99315 LASANA 3

wall / ceiling light; steel, aluminium, black / plastic, white  
Wand- / Deckenleuchte; Stahl, Alu, schwarz / Kunststoff, weiss  
applique / plafonnier; acier, aluminium, noir / plastique, blanc

L 500, B 145, H 90

LED 3x 3,5W  
warm WHITE 3x 500lm

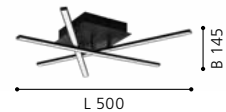



99319

LED



99318

LED

### 99319 LASANA 3

floor light; steel, aluminium, black / plastic, white  
 Stehleuchte; Stahl, Alu, schwarz / Kunststoff, weiss  
 lampadaire; acier, aluminium, noir / plastique, blanc

L 250, B 130, H 1420, Base: B 230, T 150



32W 3400lm



9 002759 993191



### 99318 LASANA 3

table light; steel, aluminium, black / plastic, white  
 Tischleuchte; Stahl, Alu, schwarz / Kunststoff, weiss  
 luminaire de table; acier, aluminium, noir / plastique, blanc

L 160, B 100, H 460, Base: B 180, T 100



10W 1100lm



9 002759 993184



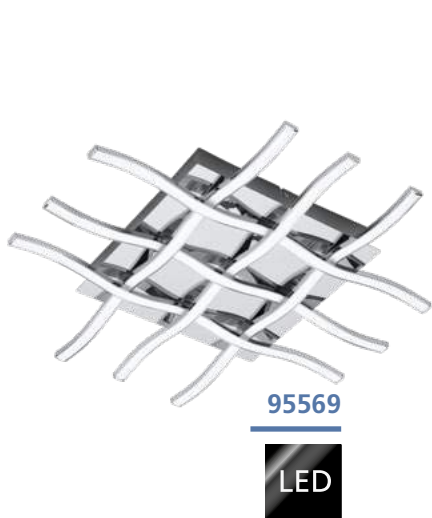

95569

LED

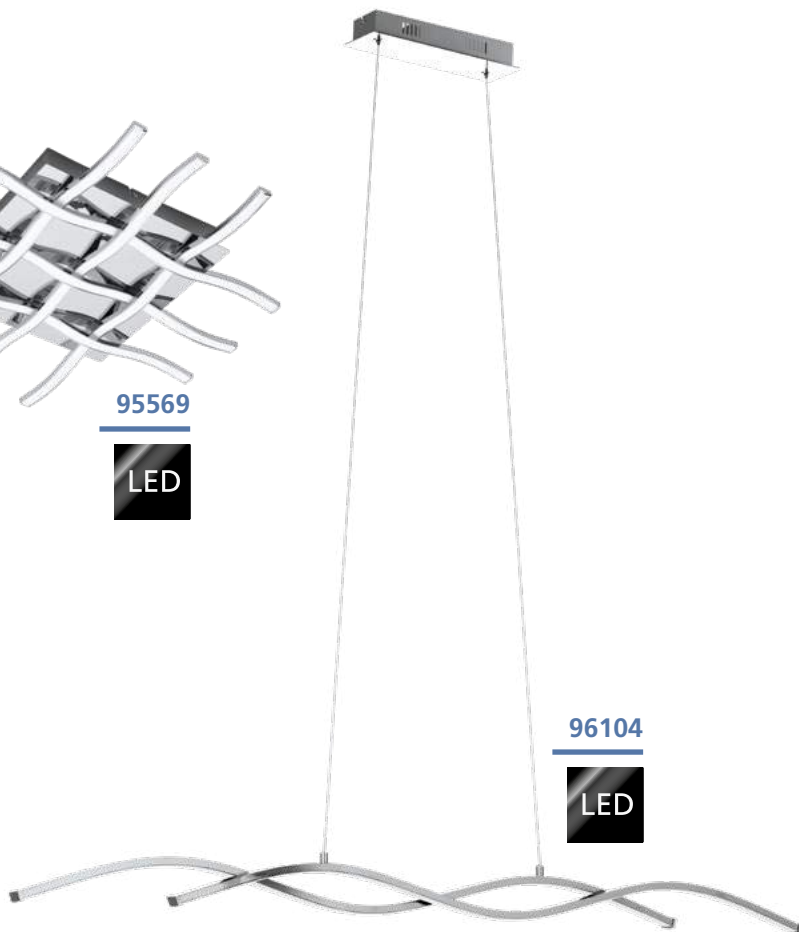

96104

LED

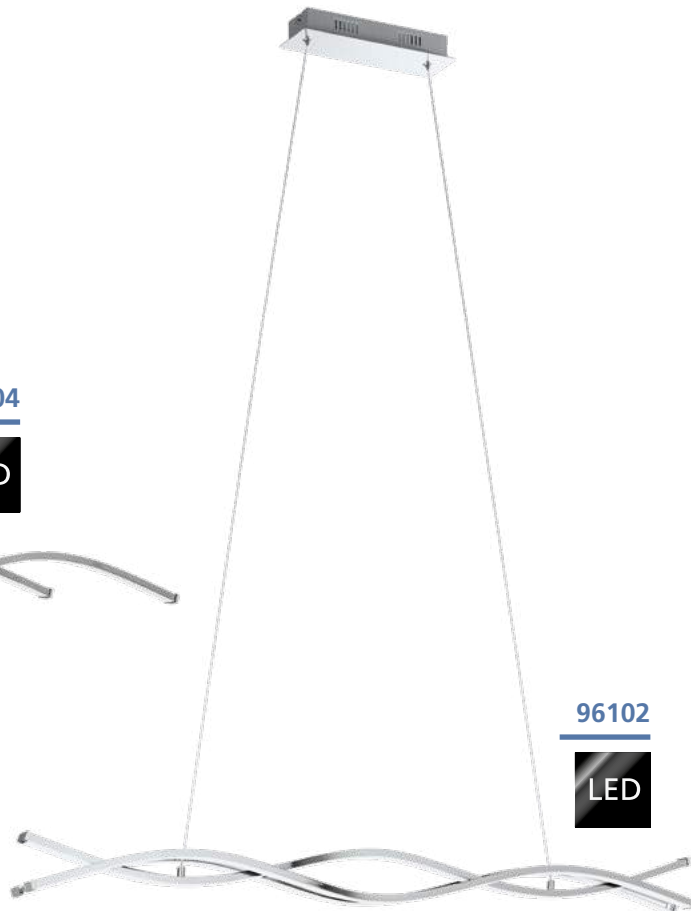

96102

LED

### 95569 LASANA 1

wall / ceiling light; steel, chrome / plastic, white  
Wand- / Deckenleuchte; Stahl, chrom / Kunststoff, weiss  
applique / plafonnier; acier, chrome / plastique, blanc

L 500, B 500, H 65

LED

warm  
WHITE



36W

3780lm



9 002759 955694

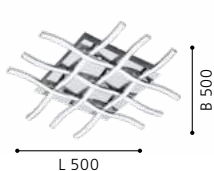

### 96104 LASANA 2

pendant light; steel, aluminium, chrome / plastic, white  
Hängeleuchte; Stahl, Alu, chrom / Kunststoff, weiss  
luminaire en suspension; acier, aluminium, chrome / plastique, blanc

L 1200, B 80, H 1200

LED

warm  
WHITE



2x 12W

2600lm



9 002759 961046

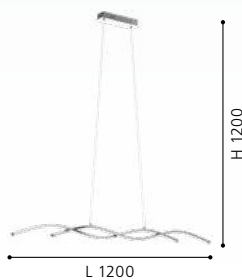

### 96102 LASANA 2

pendant light; steel, aluminium, chrome / plastic, white  
Hängeleuchte; Stahl, Alu, chrom / Kunststoff, weiss  
luminaire en suspension; acier, aluminium, chrome / plastique, blanc

L 1000, B 80, H 1200

LED

warm  
WHITE



3x 12W

3900lm



9 002759 961022



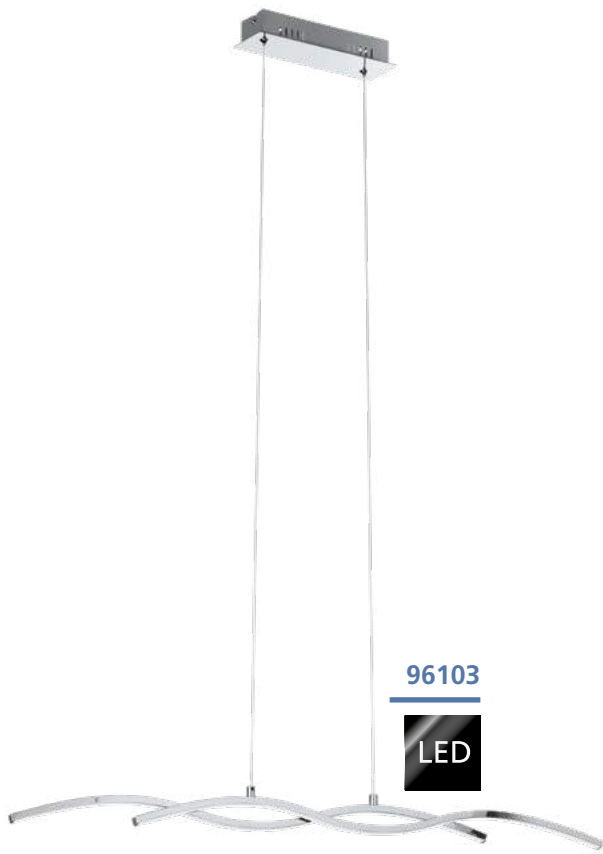

96103

LED



96105

LED



96106

LED

### 96103 LASANA 2

pendant light; steel, aluminium, chrome / plastic, white  
 Hängeleuchte; Stahl, Alu, chrom / Kunststoff, weiss  
 luminaire en suspension; acier, aluminium, chrome / plastique, blanc

L 870, B 80, H 1200



2x 9W  
 2x  
 1000lm



9 002759 961039



### 96105 LASANA 2

table light; steel, aluminium, chrome / plastic, white  
 Tischleuchte; Stahl, Alu, chrom / Kunststoff, weiss  
 luminaire de table; acier, aluminium, chrome / plastique, blanc

L 160, B 100, H 460



2x 5W  
 2x  
 500lm



9 002759 961053



### 96106 LASANA 2

floor light; steel, aluminium, chrome / plastic, white  
 Stehleuchte; Stahl, Alu, chrom / Kunststoff, weiss  
 lampadaire; acier, aluminium, chrome / plastique, blanc

L 250, B 130, H 1420

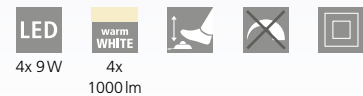

4x 9W  
 4x  
 1000lm



9 002759 961060





95147

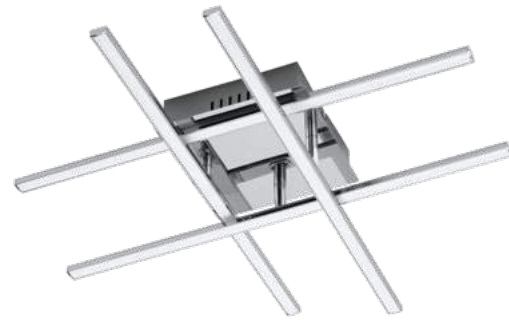

95568



32048



### 95147 LASANA

pendant light; aluminium, steel, chrome / plastic, white  
 Hängeleuchte; Alu, Stahl, chrom / Kunststoff, weiss  
 luminaire en suspension; aluminium, acier, chrome / plastique, blanc

L 900, H 1100

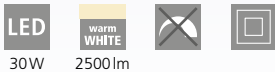

30W 2500lm



9 002759 951474

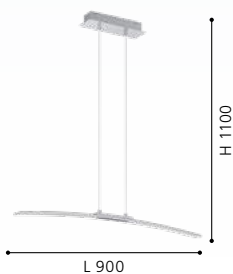

### 32048 LASANA

pendant light; aluminium, steel, chrome / plastic, white  
 Hängeleuchte; Alu, Stahl, chrom / Kunststoff, weiss  
 luminaire en suspension; aluminium, acier, chrome / plastique, blanc

L 900, H 1000

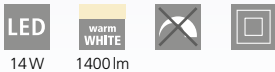

14W 1400lm



9 002759 320485

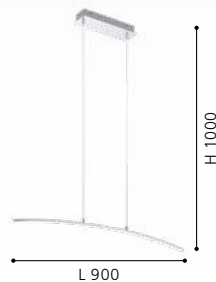

### 95568 LASANA 1

wall / ceiling light; steel, chrome / plastic, white  
 Wand- / Deckenleuchte; Stahl, chrom / Kunststoff, weiss  
 applique / plafonnier; acier, chrome / plastique, blanc

L 500, B 500, H 95



24W 2520lm



9 002759 955687

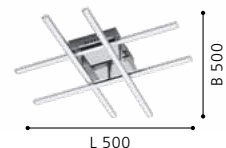





96107



96108



95567



### LASANA 2

The arms of these luminaires are movable.

Die Leuchtenarme sind beweglich.

Les bras de ces luminaires sont mobiles.

### 96107 LASANA 2

ceiling light; steel, aluminium, chrome / plastic, white  
Deckenleuchte; Stahl, Alu, chrom / Kunststoff, weiss  
plafonnier; acier, aluminium, chrome / plastique, blanc

L 1000, B 80, H 60



2x 9W  
2x  
1100lm

### 96108 LASANA 2

ceiling light; steel, aluminium, chrome / plastic, white  
Deckenleuchte; Stahl, Alu, chrom / Kunststoff, weiss  
plafonnier; acier, aluminium, chrome / plastique, blanc

L 1410, B 80, H 85



3x 7,8W  
3x  
1000lm

### 95567 LASANA 1

wall / ceiling light; steel, chrome / plastic, white  
Wand- / Deckenleuchte; Stahl, chrom / Kunststoff, weiss  
applique / plafonnier; acier, chrome / plastique, blanc

L 500, B 160, H 95



18W  
1890lm



9 002759 961077

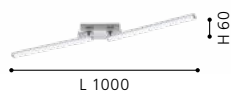

9 002759 961084



9 002759 955670

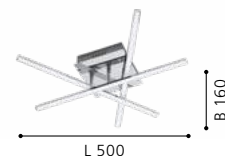



99322



99321



99323



### 99322 RONCADE 1

wall / ceiling light; steel, aluminium, black / plastic, white  
Wand- / Deckenleuchte; Stahl, Alu, schwarz / Kunststoff, weiss  
applique / plafonnier; acier, aluminium, noir / plastique, blanc

L 1160, B 180, H 115



36W 4600lm



9 002759 993221

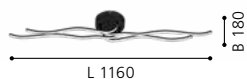

### 99321 RONCADE 1

wall / ceiling light; steel, aluminium, black / plastic, white  
Wand- / Deckenleuchte; Stahl, Alu, schwarz / Kunststoff, weiss  
applique / plafonnier; acier, aluminium, noir / plastique, blanc

L 650, B 130, H 45



21W 2800lm



9 002759 993214

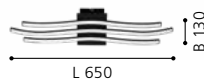

### 99323 SELVINA 1

ceiling light; steel, aluminium, black / plastic, white  
Deckenleuchte; Stahl, Alu, schwarz / Kunststoff, weiss  
plafonnier; acier, aluminium, noir / plastique, blanc

L 690, B 280, H 150



21W 3150lm



9 002759 993238





31996



31995



### 31996 RONCADE

wall / ceiling light; aluminium, steel, chrome / plastic, white  
 Wand- / Deckenleuchte; Alu, Stahl, chrom / Kunststoff, weiss  
 applique / plafonnier; aluminium, acier, chrome / plastique, blanc

L 1085, B 160, H 125



32W 4500lm

### 31995 RONCADE

wall / ceiling light; aluminium, steel, chrome / plastic, white  
 Wand- / Deckenleuchte; Alu, Stahl, chrom / Kunststoff, weiss  
 applique / plafonnier; aluminium, acier, chrome / plastique, blanc

L 650, B 130, H 45



26W 2400lm



9 002759 319960



9 002759 319953

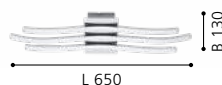

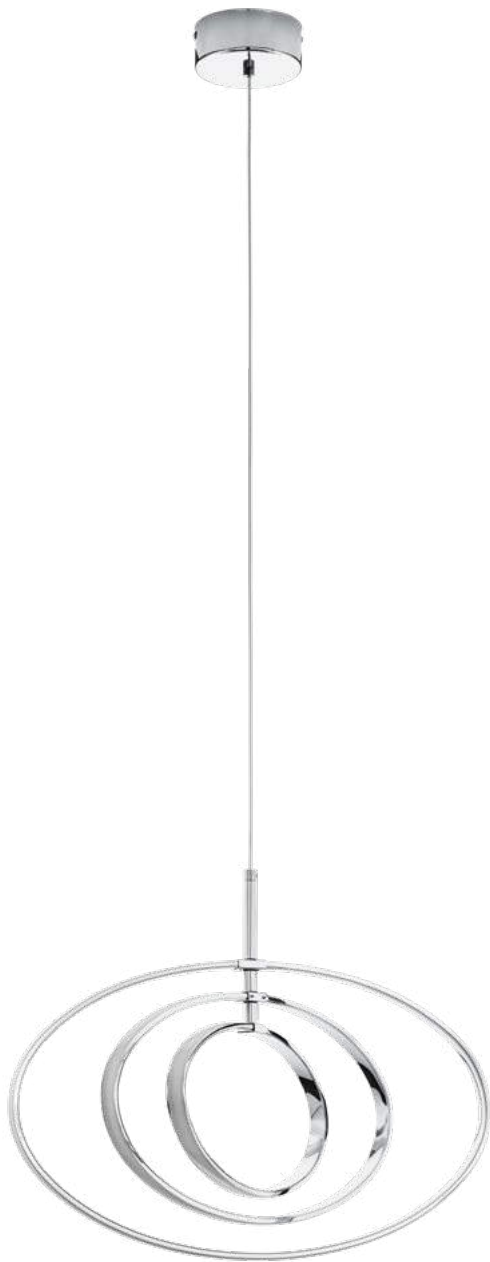

97435



96306



96308



**97435 PAUSIA**

pendant light; steel, aluminium, chrome / plastic, white  
 Hängeleuchte; Stahl, Alu, chrom / Kunststoff, weiss  
 luminaire en suspension; acier, aluminium, chrome / plastique, blanc

L 540, B 470, H 1500

- LED 1x 7W
- warm WHITE 1x 1000lm
- LED 1x 6W
- warm WHITE 1x 900lm
- LED 1x 5W
- warm WHITE 1x 800lm



9 002759 974350



**96306 SELVINA**

ceiling light; aluminium, chrome / plastic, white  
 Deckenleuchte; Alu, chrom / Kunststoff, weiss  
 plafonnier; aluminium, chrome / plastique, blanc

L 460, B 390, H 380

- LED 1x 12W
- warm WHITE 1x 1300lm
- LED 1x 14W
- warm WHITE 1x 1600lm
- LED 1x 9W
- warm WHITE 1x 1000lm



9 002759 963064

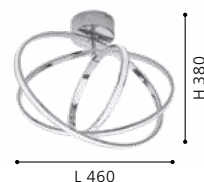

**96308 SELVINA**

ceiling light; aluminium, chrome / plastic, white  
 Deckenleuchte; Alu, chrom / Kunststoff, weiss  
 plafonnier; aluminium, chrome / plastique, blanc

L 745, B 175, H 85

- LED 1x 6W
- warm WHITE 1x 650lm
- LED 1x 7W
- warm WHITE 1x 750lm
- LED 1x 9W
- warm WHITE 1x 1000lm



9 002759 963088





96329

LED



96307

LED

### 96329 SELVINA

ceiling light; aluminium, chrome / plastic, white  
Deckenleuchte; Alu, chrom / Kunststoff, weiss  
plafonnier; aluminium, chrome / plastique, blanc

L 700, B 420, H 150



2x 10W

2x  
900lm

### 96307 SELVINA

ceiling light; aluminium, chrome / plastic, white  
Deckenleuchte; Alu, chrom / Kunststoff, weiss  
plafonnier; aluminium, chrome / plastique, blanc

H 185, Ø 520



3x 8W

3x  
900lm



9 002759 963293



L 700

B 420



9 002759 963071



Ø 520

H 185





96325

LED



96326

LED

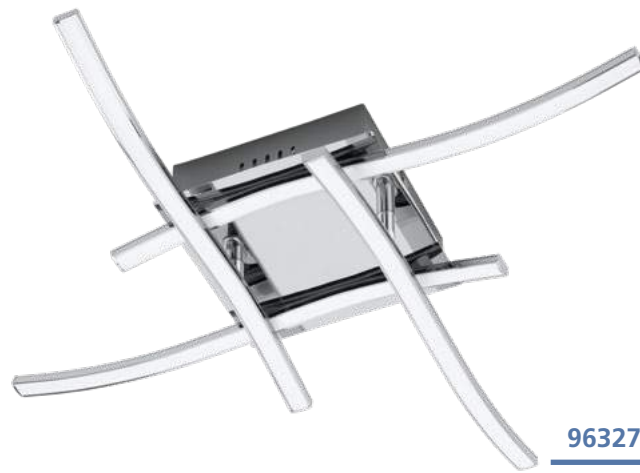

96327

LED

### 96325 VALMORA

ceiling light; aluminium, chrome / plastic, white  
Deckenleuchte; Alu, chrom / Kunststoff, weiss  
plafonnier; aluminium, chrome / plastique, blanc

L 630, B 90, H 85

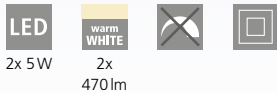

2x 5W  
2x  
470lm

### 96327 VALMORA

ceiling light; aluminium, chrome / plastic, white  
Deckenleuchte; Alu, chrom / Kunststoff, weiss  
plafonnier; aluminium, chrome / plastique, blanc

L 560, B 560, H 105

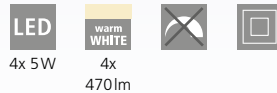

4x 5W  
4x  
470lm

### 96326 VALMORA

ceiling light; aluminium, chrome / plastic, white  
Deckenleuchte; Alu, chrom / Kunststoff, weiss  
plafonnier; aluminium, chrome / plastique, blanc

L 590, B 125, H 90



3x 5W  
3x  
470lm



9 002759 963255



L 630



9 002759 963279

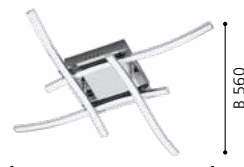

L 560



9 002759 963262



L 590



96332



96305

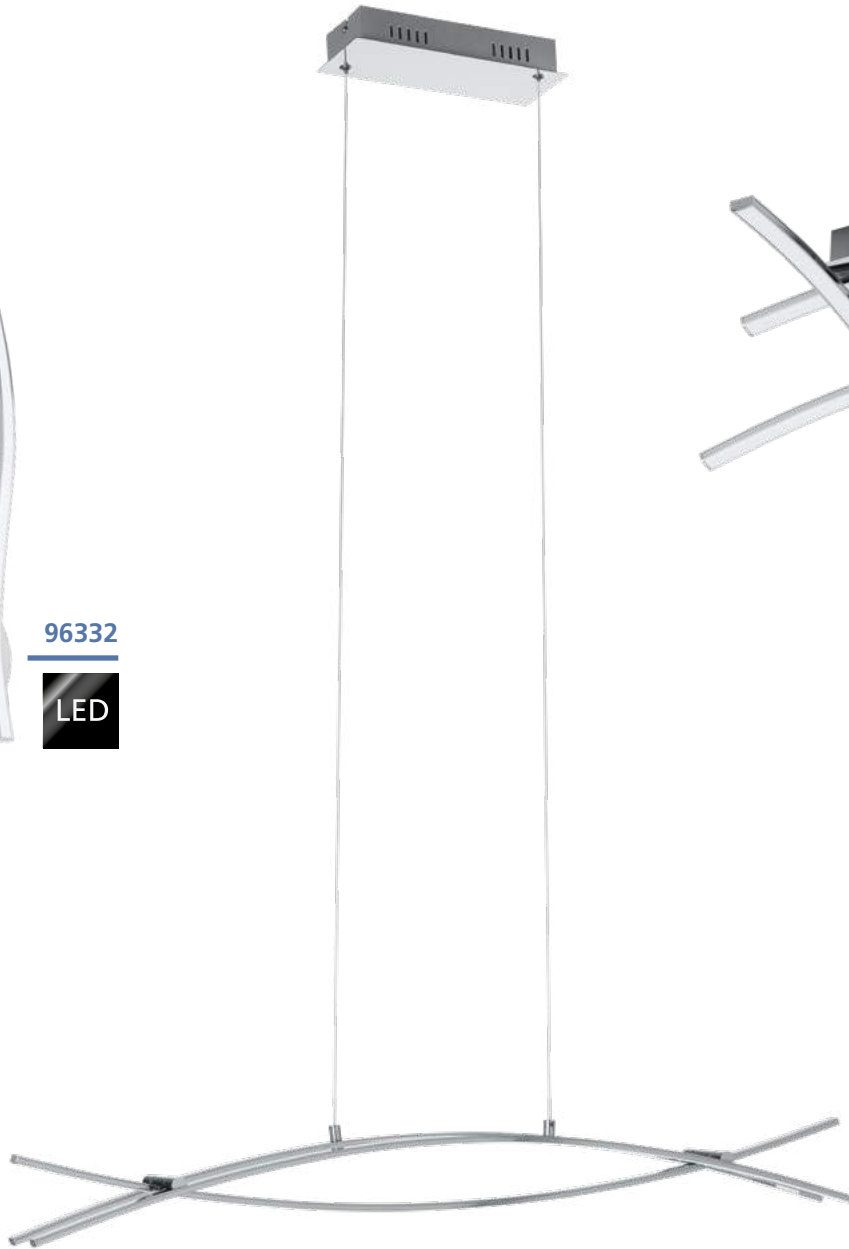

96331



### 96332 VALMORA

wall light; aluminium, chrome / plastic, white  
Wandleuchte; Alu, chrom / Kunststoff, weiss  
applique; aluminium, chrome / plastique, blanc

L 115, H 450, A 90



2x 5W  
2x  
470lm



9 002759 963323



### 96331 NEVADO

pendant light; aluminium, chrome / plastic, white  
Hängeleuchte; Alu, chrom / Kunststoff, weiss  
luminaire en suspension; aluminium, chrome / plastique, blanc

L 900, B 80, H 1100



3x 9W  
3x  
1000lm



9 002759 963316

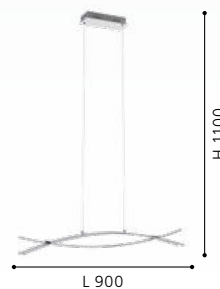

### 96305 NEVADO

ceiling light; aluminium, chrome / plastic, white  
Deckenleuchte; Alu, chrom / Kunststoff, weiss  
plafonnier; aluminium, chrome / plastique, blanc

L 500, B 500, H 115



4x 5W  
4x  
470lm



9 002759 963057

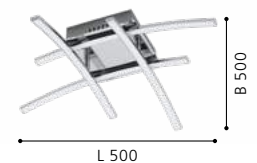



DESIGN  
HIGHLIGHT  
DETAIL

**96096 PERTINI**

pendant light; steel, aluminium, chrome / plastic, transparent  
Hängeleuchte; Stahl, Alu, chrom / Kunststoff, transparent  
luminaire en suspension; acier, aluminium, chrome / plastique, transparent

L 960, B 80, H 1100

LED warm WHITE 2x 10,8W 2x 1300lm

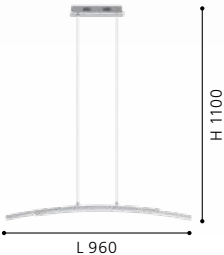

**96093 PERTINI**

ceiling light; steel, aluminium, chrome / plastic, transparent  
Deckenleuchte; Stahl, Alu, chrom / Kunststoff, transparent  
plafonnier; acier, aluminium, chrome / plastique, transparent

L 450, B 450, H 125

LED warm WHITE 4x 5W 4x 580lm

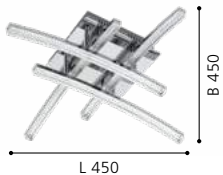

**96097 PERTINI**

wall light; steel, aluminium, chrome / plastic, transparent  
Wandleuchte; Stahl, Alu, chrom / Kunststoff, transparent  
applique; acier, aluminium, chrome / plastique, transparent

L 60, H 330, A 75

LED warm WHITE 2x 3W 2x 380lm





96409

LED



96866

LED

### 96409 LAPELA

wall / ceiling light; aluminium, steel, chrome / plastic, satined  
Wand- / Deckenleuchte; Alu, Stahl, chrom / Kunststoff, satiniert  
applique / plafonnier; aluminium, acier, chrome / plastique, satiné

L 858, B 80, H 90



2x 10W

2x  
1300lm



9 002759 964092



### 96866 TARANDELL

pendant light; aluminium, steel, chrome / plastic, satined  
Hängeleuchte; Alu, Stahl, chrom / Kunststoff, satiniert  
luminaire en suspension; aluminium, acier, chrome / plastique, satiné

L 1180, B 60, H 930 - 1620

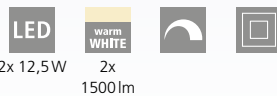

2x 12,5W

2x  
1500lm



9 002759 968663





98889



99559



### 98889 PALOZZA 1

wall light; aluminium, satin nickel / plastic, white  
Wandleuchte; Alu, nickel-matt / Kunststoff, weiss  
applique; aluminium, nickel mat / plastique, blanc

L 170, H 425, A 60



12W 1200lm



9 002759 988890



### 99559 PALOZZA 1

table light; aluminium, satin nickel / plastic, white  
Tischleuchte; Alu, nickel-matt / Kunststoff, weiss  
luminaire de table; aluminium, nickel mat / plastique, blanc

L 140, B 110, H 410



9,8W 1000lm



9 002759 995591



### 31997 RONCADE

table light; aluminium, steel, chrome / plastic, white  
Tischleuchte; Alu, Stahl, chrom / Kunststoff, weiss  
luminaire de table; aluminium, acier, chrome / plastique, blanc

L 195, B 150, H 335



14W 1200lm



9 002759 319977







31997

LED

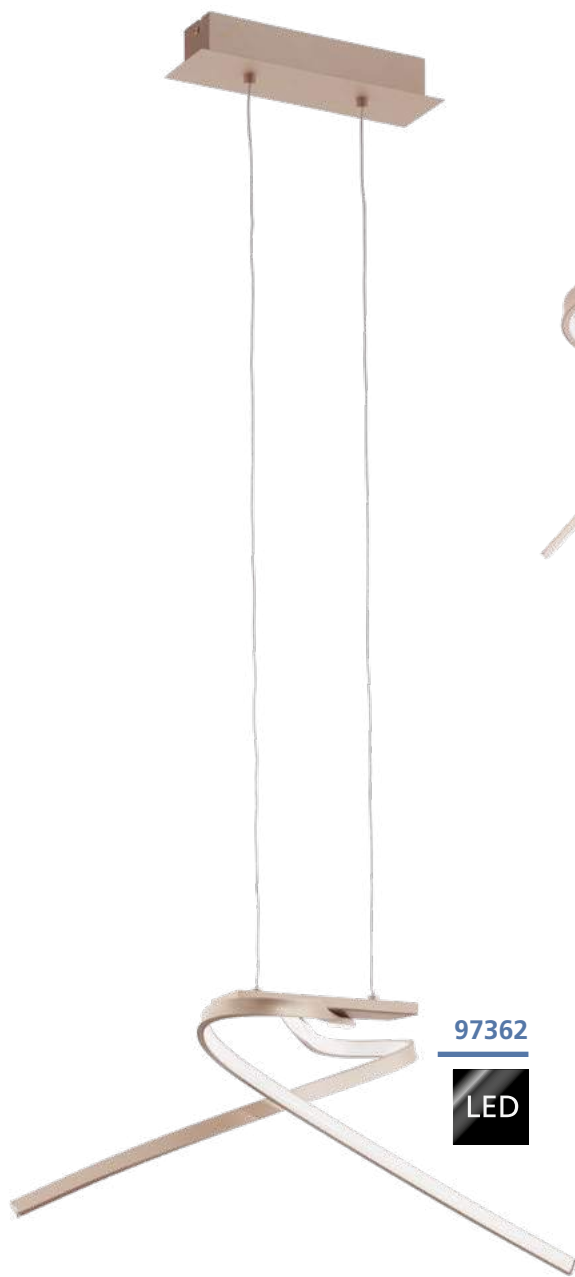

97362



97361



97363



### 97362 PALOZZA

pendant light; aluminium, rose gold / plastic, white  
Hängeleuchte; Alu, roségold / Kunststoff, weiss  
luminaire en suspension; aluminium, or rose / plastique, blanc

L 705, B 315, H 1100



2x 11 W



2x

1500lm



9 002759 973629

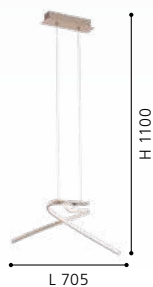

### 97361 PALOZZA

ceiling light; aluminium, rose gold / plastic, white  
Deckenleuchte; Alu, roségold / Kunststoff, weiss  
plafonnier; aluminium, or rose / plastique, blanc

L 705, B 315, H 125



2x 11 W



2x

1500lm



9 002759 973612

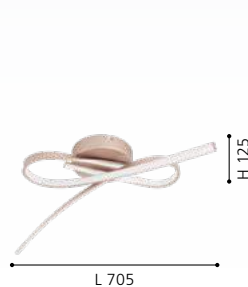

### 97363 PALOZZA

wall light; aluminium, rose gold / plastic, white  
Wandleuchte; Alu, roségold / Kunststoff, weiss  
applique; aluminium, or rose / plastique, blanc

L 170, H 425, A 60



1x 11 W



1x

1500lm



9 002759 973636





97365

LED



97364

LED

### 97365 PALOZZA

floor light; aluminium, rose gold / plastic, white  
 Stehleuchte; Alu, roségold / Kunststoff, weiss  
 lampadaire; aluminium, or rose / plastique, blanc

H 1175, Ø 220, Base: Ø 220



### 97364 PALOZZA

table light; aluminium, rose gold / plastic, white  
 Tischleuchte; Alu, roségold / Kunststoff, weiss  
 luminaire de table; aluminium, or rose / plastique, blanc

H 380, Ø 185, Base: Ø 150





97938



97937



### 97938 NOVA FELTRIA

pendant light; steel, aluminium, satin nickel / plastic, white  
 Hängeleuchte; Stahl, Alu, nickel-matt / Kunststoff, weiss  
 luminaire en suspension; acier, aluminium, nickel mat / plastique, blanc

L 900, B 200, H 1500

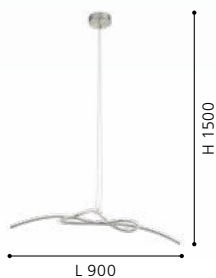

### 97937 NOVA FELTRIA

ceiling light; steel, aluminium, satin nickel / plastic, white  
 Deckenleuchte; Stahl, Alu, nickel-matt / Kunststoff, weiss  
 plafonnier; acier, aluminium, nickel mat / plastique, blanc

L 700, B 160, H 160



### 97941 NOVA FELTRIA

table light; steel, aluminium, satin nickel / plastic, white  
 Tischleuchte; Stahl, Alu, nickel-matt / Kunststoff, weiss  
 luminaire de table; acier, aluminium, nickel mat / plastique, blanc

L 160, B 160, H 410, Base: Ø 130





97941



97939



### 97939 NOVAFELTRIA

wall light; steel, aluminium, satin nickel / plastic, white  
Wandleuchte; Stahl, Alu, nickel-matt / Kunststoff, weiss  
applique; acier, aluminium, nickel mat / plastique, blanc

L 160, H 400, A 160



10W



1000lm



9 002759 979393

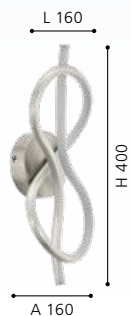



# LIGHTING FAMILIES

## GLASS CHANDELIERS

### GLASLUSTER

### LUSTRES EN VERRE

#### **SPARKLING -**

Extravagant lighting – our glass chandeliers will give you light in a new diversity while ensuring an extraordinary ambience. Our chandeliers are true jewels on your ceiling and spread their elegance in your entire living area.

#### **FUNKELN -**

Beleuchtung der Extravaganz – Mit unseren Glaslustern erleben Sie Licht in neuer Vielfalt und sorgen für ein außergewöhnliches Ambiente. Unsere Kronleuchter werden zum wahren Schmuckstück und bringen Eleganz in all Ihre Wohnbereiche.



#### **DU SCINTILLEMENT -**

Un éclairage riche en extravagance – Avec nos lustres en verre, vous faites l'expérience de la lumière dans une nouvelle multiplicité et vous assurez une ambiance extraordinaire. Nos plafonniers lustres en deviennent de vrais bijoux et prêtent de l'élégance à tous vos espaces d'habitat.



# OVERVIEW

LIGHTING FAMILIES / GLASS CHANDELIERS



BASILANO 1  
p.306



BASILANO 1  
p.306



BASILANO 1  
p.306



BASILANO 1  
p.307



BASILANO  
p.308



BASILANO  
p.308



BASILANO  
p.309



BASILANO  
p.309



CARPENTIO  
p.310



CARPENTIO  
p.310



CARPENTIO  
p.310







### 39103 BASILANO 1

pendant light; steel, chrome / glass, clear  
 Hängeleuchte; Stahl, chrom / Glas, klar  
 luminaire en suspension; acier, chrome / verre, clair

H 1500, Ø 1000



E14 18x 40W



9 002759 391034



Ø 1000

### 39101 BASILANO 1

pendant light; steel, chrome / glass, clear  
 Hängeleuchte; Stahl, chrom / Glas, klar  
 luminaire en suspension; acier, chrome / verre, clair

H 1300, Ø 820



E14 8x 40W



9 002759 391010



Ø 820

### 39099 BASILANO 1

pendant light; steel, chrome / glass, clear  
 Hängeleuchte; Stahl, chrom / Glas, klar  
 luminaire en suspension; acier, chrome / verre, clair

H 1300, Ø 720

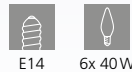

E14 6x 40W



9 002759 390990

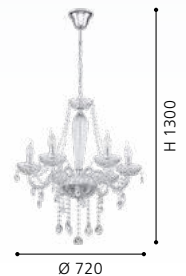

Ø 720





39099



39102

### 39102 BASILANO 1

pendant light; steel, chrome / glass, clear

Hängeleuchte; Stahl, chrom / Glas, klar

luminaire en suspension; acier, chrome / verre, clair

H 1500, Ø 1000



E14



12x 40W



9 002759 391027



H 1500

Ø 1000



39095



39092

### 39095 BASILANO

pendant light; steel, chrome / glass, cognac  
 Hängeleuchte; Stahl, chrom / Glas, cognac  
 luminaire en suspension; acier, chrome / verre, cognac

H 1500, Ø 1000



Ø 1000

### 39092 BASILANO

pendant light; steel, chrome / glass, cognac  
 Hängeleuchte; Stahl, chrom / Glas, cognac  
 luminaire en suspension; acier, chrome / verre, cognac

H 1300, Ø 720



Ø 720



39093



39094

### 39093 BASILANO

pendant light; steel, chrome / glass, cognac  
 Hängeleuchte; Stahl, chrom / Glas, cognac  
 luminaire en suspension; acier, chrome / verre, cognac

H 1300, Ø 820



E14 8x 40W



9 002759 390938



### 39094 BASILANO

pendant light; steel, chrome / glass, cognac  
 Hängeleuchte; Stahl, chrom / Glas, cognac  
 luminaire en suspension; acier, chrome / verre, cognac

H 1500, Ø 1000



E14 12x 40W



9 002759 390945







**39113**



**39112**

### 39113 CARPENTO

pendant light; steel, chrome / glass, white  
 Hängeleuchte; Stahl, chrom / Glas, weiss  
 luminaire en suspension; acier, chrome / verre, blanc

H 1200, Ø 590



E14 5x 40W



9 002759 391133



Ø 590

H 1200

### 39112 CARPENTO

pendant light; steel, chrome / glass, white  
 Hängeleuchte; Stahl, chrom / Glas, weiss  
 luminaire en suspension; acier, chrome / verre, blanc

H 1200, Ø 540



E14 3x 40W



9 002759 391126



Ø 540

H 1200

### 39114 CARPENTO

pendant light; steel, chrome / glass, white  
 Hängeleuchte; Stahl, chrom / Glas, weiss  
 luminaire en suspension; acier, chrome / verre, blanc

H 1300, Ø 700



E14 8x 40W



9 002759 391140



Ø 700

H 1300



39114





# HANGING & PENDANT LUMINAIRES

HÄNGE- & PENDELLEUCHTEN  
LUMINAIRES SUSPENSIONS

## SUSPENDED LIGHTING -

Our wide variety of suspended and pendant luminaires contain classical as well as extravagant designs and supply any furnishing style. Set beautiful accents with your favourites and give your home a special atmosphere.

## BELEUCHTUNG ZUM ABHÄNGEN -

Unser breitgefächertes Hänge- und Pendelleuchten-Sortiment beinhaltet sowohl klassische als auch extravagante Designs und bedient jeden Einrichtungsstil. Setzen Sie mit Ihren Favoriten schöne Akzente und verleihen Sie Ihrem Zuhause eine besondere Atmosphäre.



## ÉCLAIRAGES SUSPENDUS -

Notre large gamme d'éclairages suspendus et pendulaires comprend aussi bien des designs classiques qu'extravagants et est adaptée à tout style d'ameublement. Mettez avec vos favoris de beaux accents et donnez une atmosphère particulière à votre intérieur.



# OVERVIEW

## HANGING & PENDANT LUMINAIRES

 OILLELLA p. 316-317	 LEBALIO p. 318	 ALOBRASE p. 319-321	 CADAQUES p. 322	 CADAQUES 1 p. 322	 TORRONTES p. 322	 TINDARI p. 323	 ARISCANI p. 324-325
 MURMILLO p. 326	 FARSALA p. 327	 SELVINO p. 328-329	 ZABALEA p. 330	 ALBARACCIN p. 330-331	 LAGUNITAS p. 332	 CERASELLA p. 333	 ROCOMAR p. 334, 336
 ROCOMAR 1 p. 335-336	 CORETTO p. 335	 LONCINO 1 p. 337	 ALEANDRO 1 p. 338	 ROMAGNESE p. 338	 BOLSANO p. 338-339	 CARDITO 1 p. 340	 FEDRA 2 p. 341
 DIAMOND p. 341	 VARRAZO p. 341	 LUBERIO p. 342	 MONTEFIO 1 p. 342-343	 MIOGLIA 1 p. 344	 CONESSA p. 344-345	 ENALURI p. 346	 CARTAMA p. 347
 MONTEFINO p. 348	 CORTENOVA p. 350-351	 POZUETA p. 353	 BOCADELLA p. 354	 MEZZANA p. 354	 GRADOLI p. 356	 GRADOLI 1 p. 357	 MANIZALES p. 357
 MONTEBALDO p. 358	 BITACHITO p. 358	 LOBATIA p. 359	 GATUELA 1 p. 360	 GATUELA p. 360-361	 ROVIRA p. 361	 CAMARGO p. 362	 PERPIGO p. 363
 AMONTILLADO p. 364	 CAMBULOS p. 364	 SPADAFORA p. 364	 ERMUA p. 365	 CORREDERA p. 366	 BOGOTENILLO p. 366	 CODRIALES p. 367	 SALITRE p. 367

 This product is available in different colors and shapes./ Dieser Artikel ist in unterschiedlichen Farben und Formen verfügbar.  
Cet article est disponible en différentes couleurs et formes.

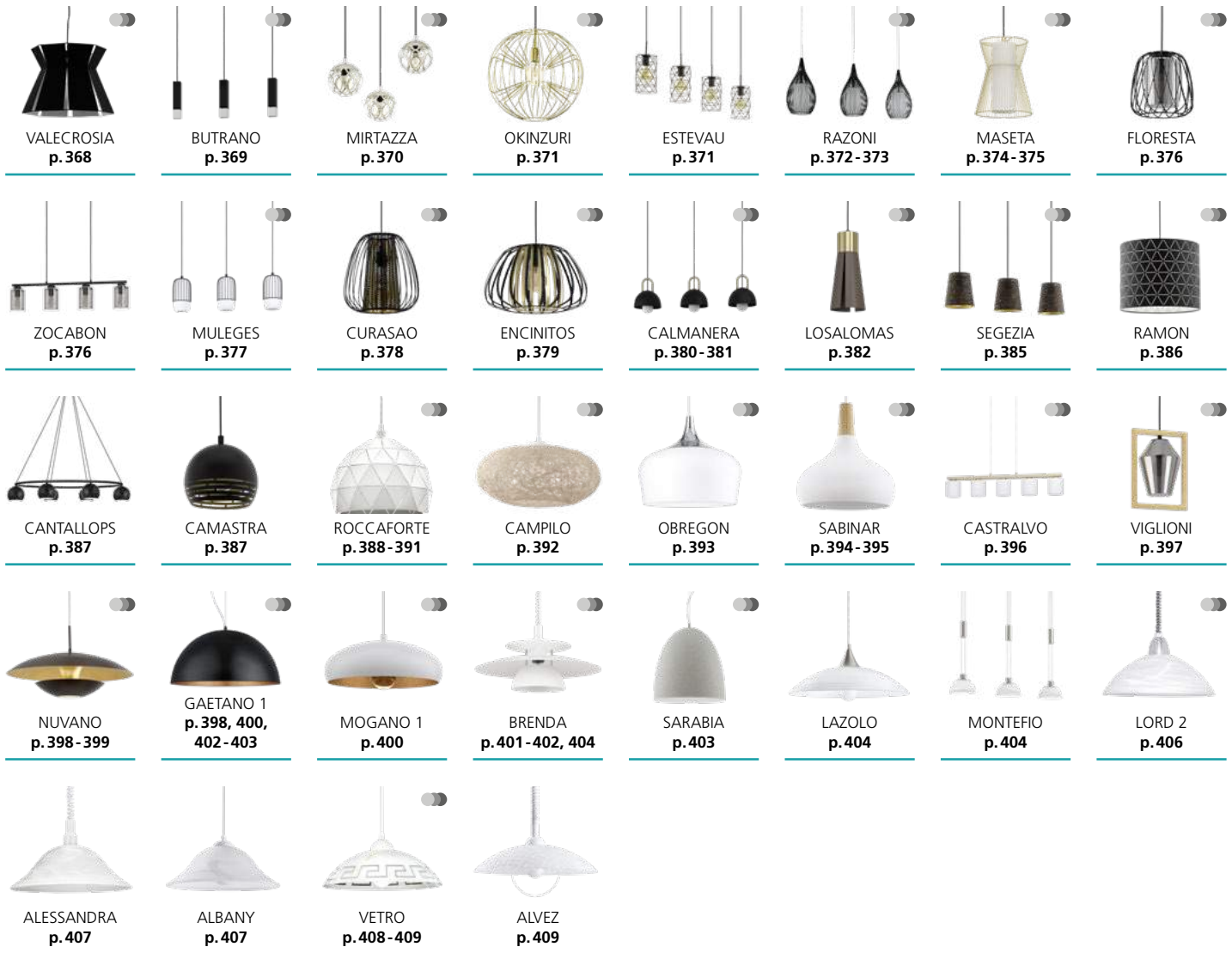



### 99614 OIELLA

pendant light; steel, black, brass / glass vaporized, black-brown-transparent

Hängeleuchte; Stahl, schwarz, messing / Glas bedampft, schwarz-braun-transparent

luminaire en suspension; acier, noir, laiton / verre vaporisé, noir-marron-transparent

H 1100, Ø 190



E27

1x 40W



9 002759 996147

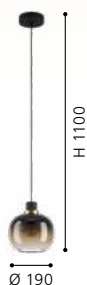

### 99615 OIELLA

pendant light; steel, black, brass / glass vaporized, black-brown-transparent

Hängeleuchte; Stahl, schwarz, messing / Glas bedampft, schwarz-braun-transparent

luminaire en suspension; acier, noir, laiton / verre vaporisé, noir-marron-transparent

L 950, B 190, H 1100



E27

3x 40W



9 002759 996154



### 99616 OIELLA

pendant light; steel, black, brass / glass vaporized, black-grey-transparent

Hängeleuchte; Stahl, schwarz, messing / Glas bedampft, schwarz-grau-transparent

luminaire en suspension; acier, noir, laiton / verre vaporisé, noir-gris-transparent

H 1100, Ø 190



E27

1x 40W



9 002759 996161

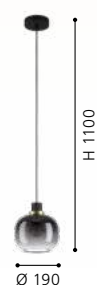





99617

### 99617 OILELLA

pendant light; steel, black, brass / glass vaporized,  
black-grey-transparent

Hängeleuchte; Stahl, schwarz, messing / Glas bedampft,  
schwarz-grau-transparent

luminaire en suspension; acier, noir, laiton / verre vaporisé,  
noir-gris-transparent

L 950, B 190, H 1100



E27



3x 40W



DESIGN  
HIGHLIGHT  
DETAIL



**99313**



**99314**



99313 | 99314

### 99313 LEBALIO

pendant light; steel, bronzed / glass vaporized, black-transparent  
 Hängeleuchte; Stahl, brüniert / Glas bedampft, schwarz-transparent  
 luminaire en suspension; acier, bruni / verre vaporisé, noir transparent

H 1100, Ø 195



### 99314 LEBALIO

pendant light; steel, bronzed / glass vaporized, black-transparent  
 Hängeleuchte; Stahl, brüniert / Glas bedampft, schwarz-transparent  
 luminaire en suspension; acier, bruni / verre vaporisé, noir transparent

L 1125, B 195, H 1100

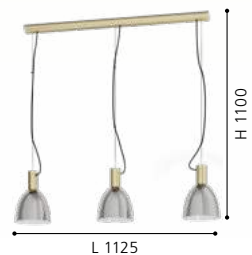



98647 | 98648 | 98649

### 98647 ALOBRASE

pendant light; steel, brushed brass / glass vaporized, amber  
 Hängeleuchte; Stahl, messing-gebürstet / Glas bedampft, amber  
 luminaire en suspension; acier, laiton brossé / verre vaporisé, ambre

H 1100, Ø 300



9 002759 986476



H 1100

Ø 300

### 98648 ALOBRASE

pendant light; steel, brushed brass / glass vaporized, amber  
 Hängeleuchte; Stahl, messing-gebürstet / Glas bedampft, amber  
 luminaire en suspension; acier, laiton brossé / verre vaporisé, ambre

H 1100, Ø 200



9 002759 986483

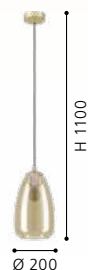

H 1100

Ø 200

### 98649 ALOBRASE

pendant light; steel, brushed brass / glass vaporized, amber  
 Hängeleuchte; Stahl, messing-gebürstet / Glas bedampft, amber  
 luminaire en suspension; acier, laiton brossé / verre vaporisé, ambre

L 1080, B 150, H 1100



9 002759 986490

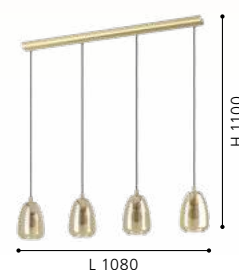

H 1100

L 1080

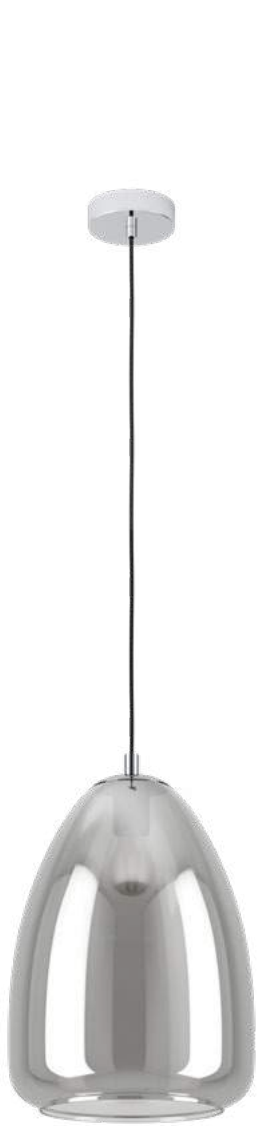

98614



98616



98614 | 98615 | 98616 |  
98617

### 98614 ALOBRASE

pendant light; steel, chrome / glass vaporized, black-transparent  
Hängeleuchte; Stahl, chrom / Glas bedampft, schwarz-transparent  
luminaire en suspension; acier, chrome / verre vaporisé, noir transparent

H 1100, Ø 300



E27 1x 40W



9 002759 986148

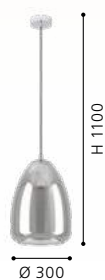

### 98616 ALOBRASE

pendant light; steel, chrome / glass vaporized, black-transparent  
Hängeleuchte; Stahl, chrom / Glas bedampft, schwarz-transparent  
luminaire en suspension; acier, chrome / verre vaporisé, noir transparent

L 1080, B 150, H 1100



E27 4x 40W



9 002759 986162

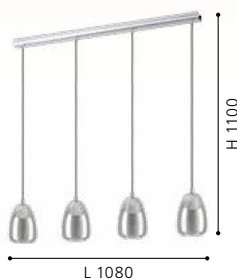

### 98615 ALOBRASE

pendant light; steel, chrome / glass vaporized, black-transparent  
Hängeleuchte; Stahl, chrom / Glas bedampft, schwarz-transparent  
luminaire en suspension; acier, chrome / verre vaporisé, noir transparent

H 1100, Ø 200



E27 1x 40W



9 002759 986155

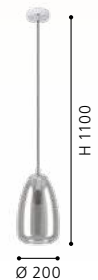



98615

### 98617 ALOBRASE

pendant light; steel, chrome / glass vaporized, black-transparent  
Hängeleuchte; Stahl, chrom / Glas bedampft, schwarz-transparent  
luminaire en suspension; acier, chrome / verre vaporisé, noir transparent

H 1500, Ø 540



E27 5x 40W



9 002759 986179

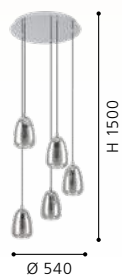

98617





98582 | 98585

98582



98585



98291

98291

### 98582 CADAQUES

pendant light; steel, black / smoked glass, black-transparent  
Hängeleuchte; Stahl, schwarz / Rauchglas, schwarz-transparent  
luminaire en suspension; acier, noir / verre fumé, noir transparent

H 1100, Ø 180



E27 1x 40W



9 002759 985820

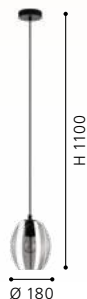

### 98585 CADAQUES 1

pendant light; steel, black / smoked glass, black-transparent  
Hängeleuchte; Stahl, schwarz / Rauchglas, schwarz-transparent  
luminaire en suspension; acier, noir / verre fumé, noir transparent

H 1100, Ø 160



E27 1x 40W



9 002759 985851



### 98291 TORRONTES

pendant light; steel, nickel-nero / smoked glass, black-transparent  
Hängeleuchte; Stahl, nickel-nero / Rauchglas, schwarz-transparent  
luminaire en suspension; acier, nickel noir / verre fumé, noir transparent

H 1100, Ø 345



E27 1x 60W



9 002759 982911

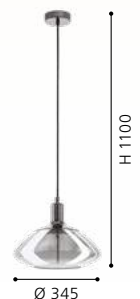



97633

### 97633 TINDARI

pendant light; steel, nickel-nero / glass, black-transparent, white  
Hängeleuchte; Stahl, nickel-nero / Glas, schwarz-transparent, weiss

luminaire en suspension; acier, nickel noir / verre, noir transparent, blanc

H 1100, Ø 250



E27



1x 60W



9 002759 976330



**97633**



98651 | 98652 | 98653 |  
98654



98651

98652

### 98651 ARISCANI

pendant light; steel, black / glass vaporized, black-transparent  
Hängeleuchte; Stahl, schwarz / Glas bedampft, schwarz-transparent  
luminaire en suspension; acier, noir / verre vaporisé, noir transparent

H 1100, Ø 200



9 002759 986513

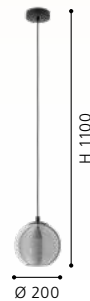

### 98652 ARISCANI

pendant light; steel, black / glass vaporized, black-transparent  
Hängeleuchte; Stahl, schwarz / Glas bedampft, schwarz-transparent  
luminaire en suspension; acier, noir / verre vaporisé, noir transparent

L 765, B 165, H 1100



9 002759 986520

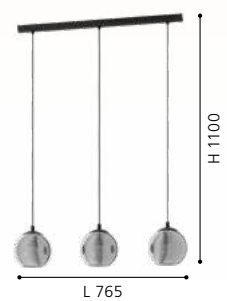



98654



98653

### 98654 ARISCANI

pendant light; steel, black / glass vaporized, black-transparent  
 Hängeleuchte; Stahl, schwarz / Glas bedampft, schwarz-transparent  
 luminaire en suspension; acier, noir / verre vaporisé, noir transparent

H 1700, Ø 655



E27 10x 40W



9 002759 986544

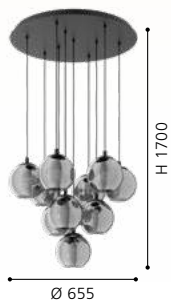

### 98653 ARISCANI

pendant light; steel, black / glass vaporized, black-transparent  
 Hängeleuchte; Stahl, schwarz / Glas bedampft, schwarz-transparent  
 luminaire en suspension; acier, noir / verre vaporisé, noir transparent

H 1100, Ø 425



E27 3x 40W



9 002759 986537

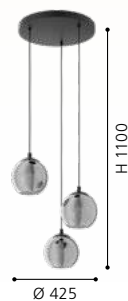



**96774**

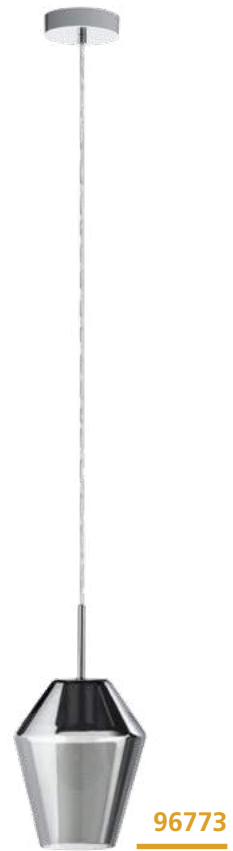

**96773**



96773 | 96774

### 96774 MURMILLO

pendant light; steel, chrome / smoked glass, black-transparent  
 Hängeleuchte; Stahl, chrom / Rauchglas, schwarz-transparent  
 luminaire en suspension; acier, chrome / verre fumé, noir transparent

L 770, B 170, H 1500



### 96773 MURMILLO

pendant light; steel, chrome / smoked glass, black-transparent  
 Hängeleuchte; Stahl, chrom / Rauchglas, schwarz-transparent  
 luminaire en suspension; acier, chrome / verre fumé, noir transparent

H 1500, Ø 170







### 96343 FARSALA

pendant light; steel, satin nickel / smoked glass, granilla, black-transparent, clear

Hängeleuchte; Stahl, nickel-matt / Rauchglas, Granille, schwarz-transparent, klar

luminaire en suspension; acier, nickel mat / verre fumé, granille, noir transparent, clair

H 1100, Ø 125

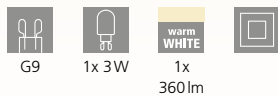

9 002759 963439



### 96344 FARSALA

pendant light; steel, satin nickel / smoked glass, granilla, black-transparent, clear

Hängeleuchte; Stahl, nickel-matt / Rauchglas, Granille, schwarz-transparent, klar

luminaire en suspension; acier, nickel mat / verre fumé, granille, noir transparent, clair

L 975, B 100, H 1100

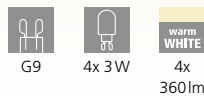

9 002759 963446

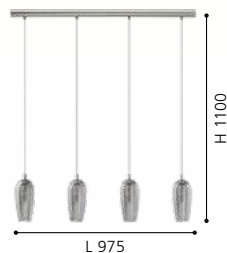

### 96345 FARSALA

pendant light; steel, satin nickel / smoked glass, granilla, black-transparent, clear

Hängeleuchte; Stahl, nickel-matt / Rauchglas, Granille, schwarz-transparent, klar

luminaire en suspension; acier, nickel mat / verre fumé, granille, noir transparent, clair

H 1500, Ø 350

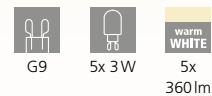

9 002759 963453





**98694**



98694 | 98695



**98695**



**98696**

### 98694 SELVINO

pendant light; steel, satin nickel / glass vaporized, black-transparent

Hängeleuchte; Stahl, nickel-matt / Glas bedampft, schwarz-transparent

luminaire en suspension; acier, nickel mat / verre vaporisé, noir transparent

H 1100, Ø 100



E27



1x 15W



9 002759 986940

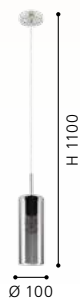

### 98695 SELVINO

pendant light; steel, satin nickel / glass vaporized, black-transparent

Hängeleuchte; Stahl, nickel-matt / Glas bedampft, schwarz-transparent

luminaire en suspension; acier, nickel mat / verre vaporisé, noir transparent

L 710, B 100, H 1100



E27



3x 15W



9 002759 986957



### 98696 SELVINO

pendant light; steel, satin nickel / glass vaporized, gold color

Hängeleuchte; Stahl, nickel-matt / Glas bedampft, goldfarben

luminaire en suspension; acier, nickel mat / verre vaporisé, couleurs d'or

H 1100, Ø 100



E27



1x 15W



9 002759 986964

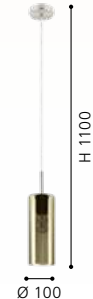



98696 | 98697 | 98698 | 98699

### 98697 SELVINO

pendant light; steel, satin nickel / glass vaporized, gold color  
Hängeleuchte; Stahl, nickel-matt / Glas bedampft, goldfarben  
luminaire en suspension; acier, nickel mat / verre vaporisé, couleurs d'or

L 710, B 100, H 1100



### 98698 SELVINO

pendant light; steel, satin nickel / glass vaporized, copper-coloured  
Hängeleuchte; Stahl, nickel-matt / Glas bedampft, kupferfarben  
luminaire en suspension; acier, nickel mat / verre vaporisé, cuivré

H 1100, Ø 100

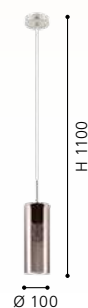

### 98699 SELVINO

pendant light; steel, satin nickel / glass vaporized, copper-coloured  
Hängeleuchte; Stahl, nickel-matt / Glas bedampft, kupferfarben  
luminaire en suspension; acier, nickel mat / verre vaporisé, cuivré

L 710, B 100, H 1100





98765

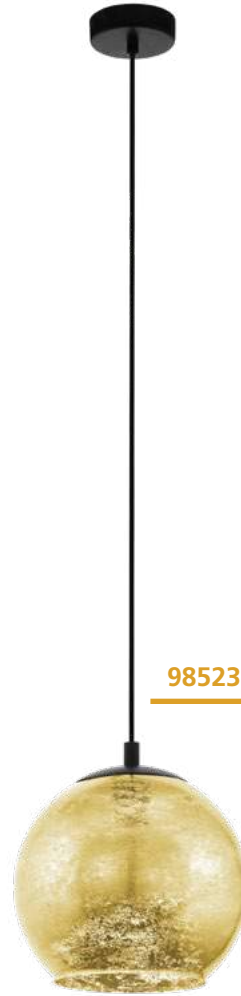

98523

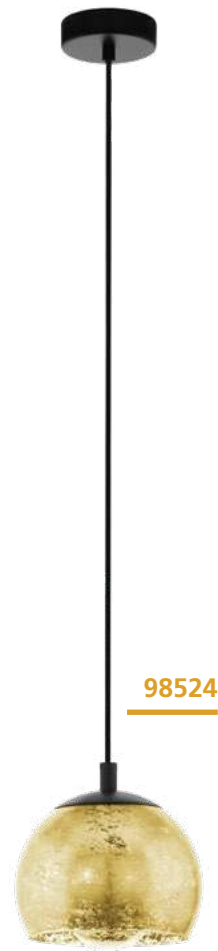

98524

### 98765 ZABALEA

pendant light; steel, black / glass, bronze transparent  
 Hängeleuchte; Stahl, schwarz / Glas, bronze-transparent  
 luminaire en suspension; acier, noir / verre, bronze transparent

L 785, B 110, H 1100



E14 4x 40W



9 002759 987657



### 98523 ALBARACCIN

pendant light; steel, black / glass, gold color  
 Hängeleuchte; Stahl, schwarz / Glas, goldfarben  
 luminaire en suspension; acier, noir / verre, couleurs d'or

H 1100, Ø 270



E27 1x 40W



9 002759 985233

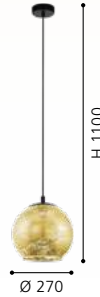

### 98524 ALBARACCIN

pendant light; steel, black / glass, gold color  
 Hängeleuchte; Stahl, schwarz / Glas, goldfarben  
 luminaire en suspension; acier, noir / verre, couleurs d'or

H 1100, Ø 190



E27 1x 40W



9 002759 985240





98526



98525

### 98526 ALBARACCIN

pendant light; steel, black / glass, gold color  
 Hängeleuchte; Stahl, schwarz / Glas, goldfarben  
 luminaire en suspension; acier, noir / verre, couleurs d'or

H 1500, Ø 585



E27 5x 40W



9 002759 985264



### 98525 ALBARACCIN

pendant light; steel, black / glass, gold color  
 Hängeleuchte; Stahl, schwarz / Glas, goldfarben  
 luminaire en suspension; acier, noir / verre, couleurs d'or

L 780, B 190, H 1100



E27 3x 40W



9 002759 985257







**99654**



**99651**

### 99654 LAGUNITAS

pendant light; steel, black, brass, gold / glass, clear  
 Hängeleuchte; Stahl, schwarz, messing, gold / Glas, klar  
 luminaire en suspension; acier, noir, laiton, or / verre, clair

L 910, B 150, H 1100

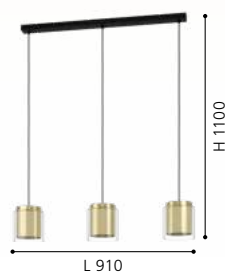

### 99651 LAGUNITAS

pendant light; steel, black, brass, gold / glass, clear  
 Hängeleuchte; Stahl, schwarz, messing, gold / Glas, klar  
 luminaire en suspension; acier, noir, laiton, or / verre, clair

H 1100, Ø 150

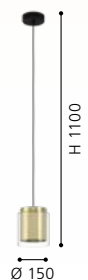



99628

LED

99629

LED



### 99628 CERASELLA

pendant light; steel, brushed brass / glass, clear  
 Hängeleuchte; Stahl, messing-gebürstet / Glas, klar  
 luminaire en suspension; acier, laiton brossé / verre, clair

H 1100, Ø 200

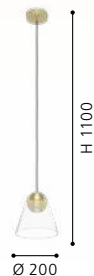
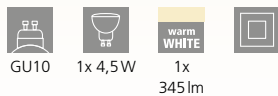

### 99629 CERASELLA

pendant light; steel, brushed brass / glass, clear  
 Hängeleuchte; Stahl, messing-gebürstet / Glas, klar  
 luminaire en suspension; acier, laiton brossé / verre, clair

L 900, B 200, H 1100





94589

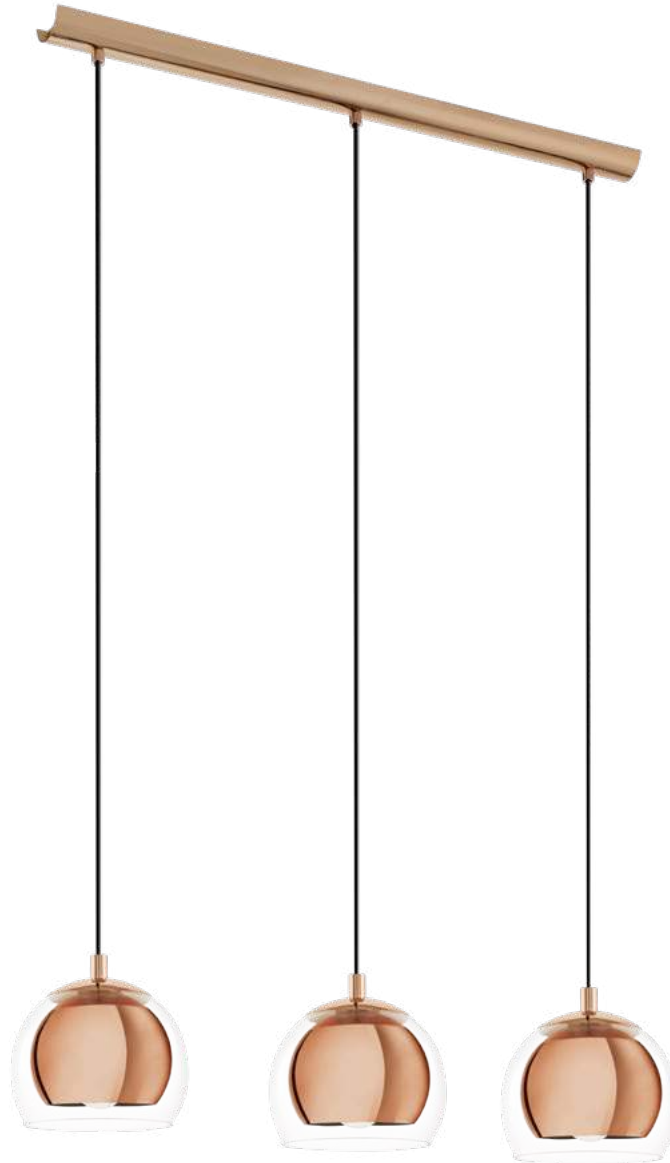

94591



### 94589 ROCAMAR

pendant light; steel, copper / glass, clear  
Hängeleuchte; Stahl, kupfer / Glas, klar  
luminaire en suspension; acier, cuivre / verre, clair

H 1100, Ø 190



E27 1x 40W



9 002759 945893

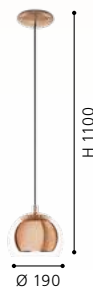

### 94591 ROCAMAR

pendant light; steel, copper / glass, clear  
Hängeleuchte; Stahl, kupfer / Glas, klar  
luminaire en suspension; acier, cuivre / verre, clair

L 780, B 190, H 1100



E27 3x 40W



9 002759 945916

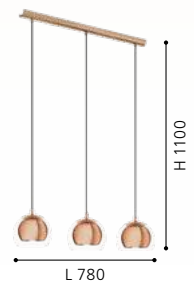



**98595**



**93836**



**98595 ROCAMAR 1**

pendant light; steel, copper / glass, clear  
 Hängeleuchte; Stahl, kupfer / Glas, klar  
 luminaire en suspension; acier, cuivre / verre, clair

H 1500, Ø 585

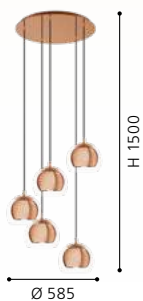

**93836 CORETTO**

pendant light; steel, brushed copper  
 Hängeleuchte; Stahl, kupfer-gebürstet  
 luminaire en suspension; acier, cuivre brossé

H 1100, Ø 170

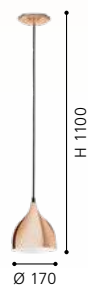



94592

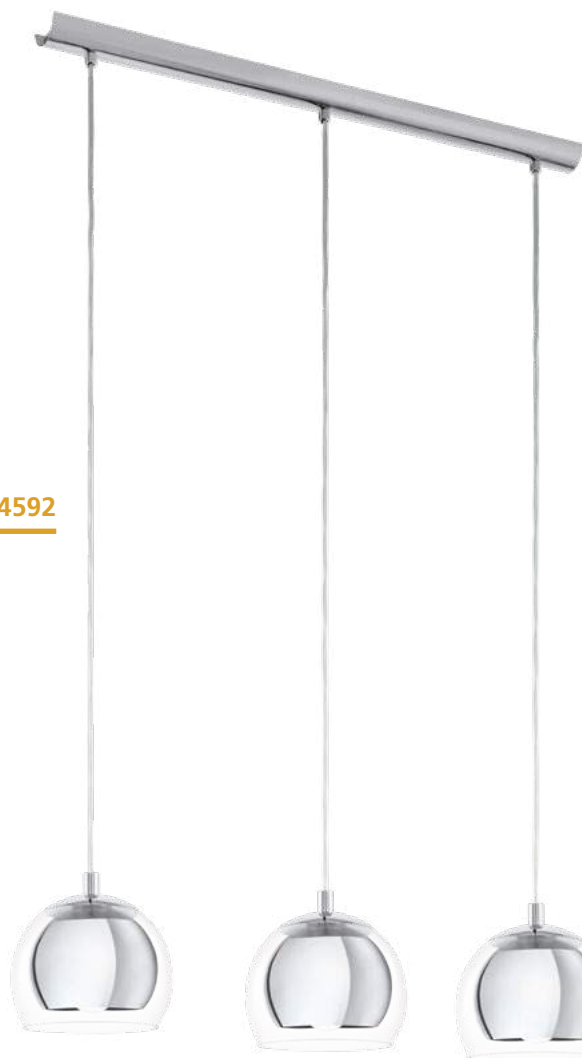

94593



98596

### 94592 ROCAMAR

pendant light; steel, chrome / glass, clear  
Hängeleuchte; Stahl, chrom / Glas, klar  
luminaire en suspension; acier, chrome / verre, clair

H 1100, Ø 190



E27



1x 40W



9 002759 945923



### 94593 ROCAMAR

pendant light; steel, chrome / glass, clear  
Hängeleuchte; Stahl, chrom / Glas, klar  
luminaire en suspension; acier, chrome / verre, clair

L 780, B 190, H 1100



E27



3x 40W



9 002759 945930

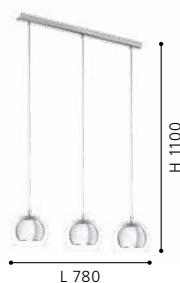

### 98596 ROCAMAR 1

pendant light; steel, chrome / glass, clear  
Hängeleuchte; Stahl, chrom / Glas, klar  
luminaire en suspension; acier, chrome / verre, clair

H 1500, Ø 585



E27



5x 28W



9 002759 985967

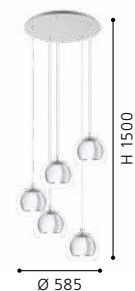





DESIGN  
HIGHLIGHT  
DETAIL



94377 | 94378

### 94378 LONCINO 1

pendant light; steel, chrome / glass, satin glass, clear, white  
Hängeleuchte; Stahl, chrom / Glas, Glas satiniert, klar, weiss  
luminaire en suspension; acier, chrome / verre, verre satiné, clair, blanc

L 745, B 150, H 1100



9 002759 943783



### 94377 LONCINO 1

pendant light; steel, chrome / glass, satin glass, clear, white  
Hängeleuchte; Stahl, chrom / Glas, Glas satiniert, klar, weiss  
luminaire en suspension; acier, chrome / verre, verre satiné, clair, blanc

L 150, B 150, H 1100



9 002759 943776

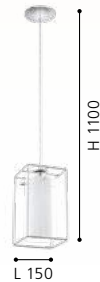



96528

LED

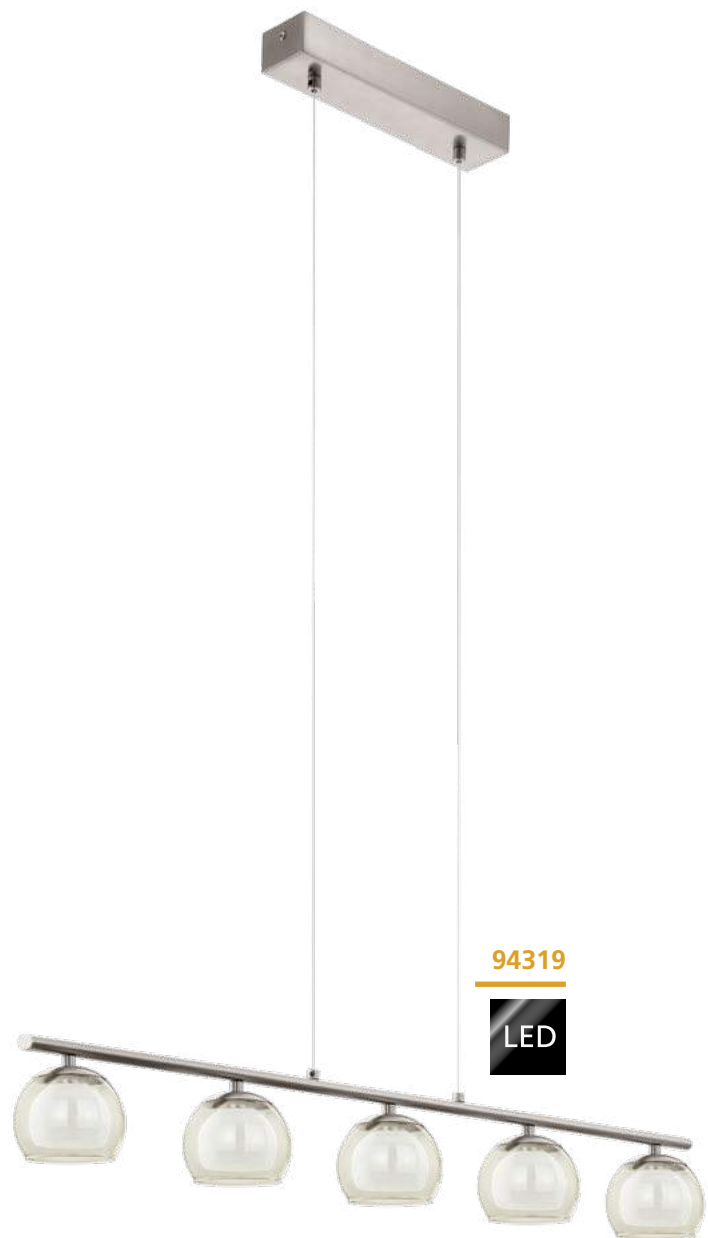

94319

LED

### 96528 ALEANDRO 1

pendant light; steel, chrome / glass opal-matt, white  
Hängeleuchte; Stahl, chrom / Glas opal-matt, weiss  
luminaire en suspension; acier, chrome / verre opale mat, blanc

L 800, B 120, H 860 - 1550

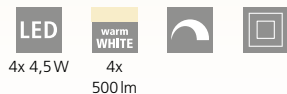

9 002759 965280

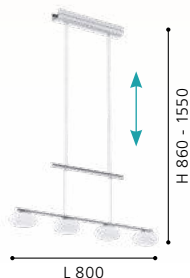

### 94319 ROMAGNESE

pendant light; steel, satin nickel / glass, satin glass, amber, white  
Hängeleuchte; Stahl, nickel-matt / Glas, Glas satiniert, amber, weiss  
luminaire en suspension; acier, nickel mat / verre, verre satiné, ambre, blanc

L 900, B 105, H 1100



9 002759 943196



### 92761 BOLSANO

pendant light; steel, chrome / satin glass, glass, white, clear  
Hängeleuchte; Stahl, chrom / Glas satiniert, Glas, weiss, klar  
luminaire en suspension; acier, chrome / verre satiné, verre, blanc, clair

H 1300, Ø 200



9 002759 927615

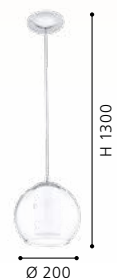



**92761**

### 92762 BOLSANO

pendant light; steel, chrome / satin glass, glass, white, clear  
Hängeleuchte; Stahl, chrom / Glas satiniert, Glas, weiss, klar  
luminaire en suspension; acier, chrome / verre satiné, verre,  
blanc, clair

H 1300, Ø 505



E27



3x 60W



9 002759 927622

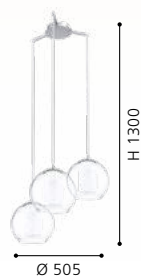

**92762**



93625

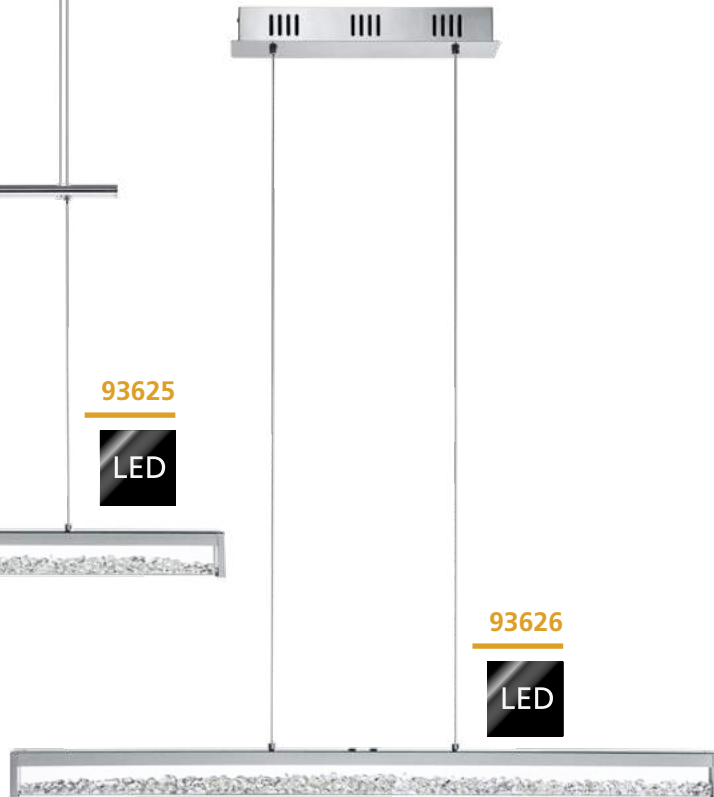

93626



93092

93092

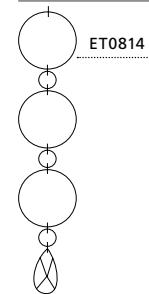

ET0814

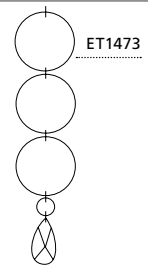

ET1473



TOUCH ME



see the tunable white video  
unser Tunable White Video  
notre video de blanc réglable

## CARDITO 1



Warm White 2700K Neutral White Cold White 5000K

These luminaires can be switched on and off by touching the specially designed "Touch Me" part of the fixture. Features via touch-dimmer:

- > light colour adjustable between 2700 - 5000 K
- > dimmable 10% - 100%

Diese Leuchten können ein und ausgeschaltet werden, indem man sie an den dafür vorgesehenen "Touch Me" Bereichen berührt. Per Touch-Dimmer verfügen diese Leuchten über folgende Funktionen:

- > Lichtfarbe einstellbar im Bereich 2700 bis 5000 K
- > dimmbar 10% bis 100%

Ces luminaires peuvent être éteints et allumés simplement en touchant la partie spécialement conçue pour "Touch Me" du luminaire. Fonctions du gradateur "touch" :

- > couleur lumineuse réglable de 2700 - 5000 K
- > réglable en luminosité 10% - 100%

## 93625 CARDITO 1

pendant light; aluminium, steel, chrome / glass, crystal, clear  
Hängeleuchte; Alu, Stahl, chrom / Glas, Kristall, klar  
luminaire en suspension; aluminium, acier, chrome / verre, cristal, clair

L 700, B 80, H 750 - 1300



24W



2000lm



9 002759 936259

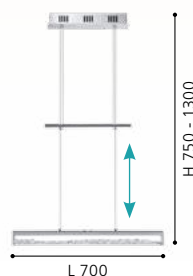

L 700

H 750 - 1300

## 93626 CARDITO 1

pendant light; aluminium, steel, chrome / glass, crystal, clear  
Hängeleuchte; Alu, Stahl, chrom / Glas, Kristall, klar  
luminaire en suspension; aluminium, acier, chrome / verre, cristal, clair

L 1000, B 80, H 1100



32W



2500lm



9 002759 936266

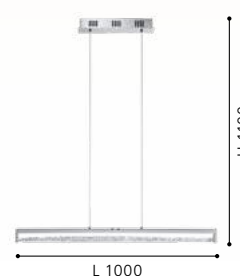

L 1000

H 1100



90696



90696



31667

LED

### 93092 FEDRA 2

pendant light; steel, chrome / film, crystal, mother-of-pearl, clear  
Hängeleuchte; Stahl, chrom / Folie, Kristall, perlmutt, klar  
luminaire en suspension; acier, chrome / film, cristal, nacré, clair

H 1100, Ø 250

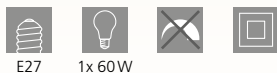

### 90696 DIAMOND

pendant light; steel, chrome / glass, crystal, clear, chrome  
Hängeleuchte; Stahl, chrom / Glas, Kristall, klar, chrom  
luminaire en suspension; acier, chrome / verre, cristal, clair, chrome

L 1010, B 105, H 1100

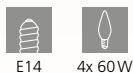

### 31667 VARRAZO

pendant light; steel, chrome / crystal, clear  
Hängeleuchte; Stahl, chrom / Kristall, klar  
luminaire en suspension; acier, chrome / cristal, clair

H 1200, Ø 550

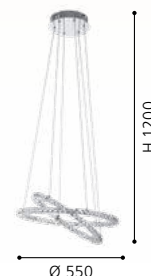





### MONTEFIO 1

These luminaires come with high quality glass crystals.

Diese Leuchten sind mit hochwertigen Glaskristallen ausgestattet.

Ces luminaires viennent avec des cristaux de verre de haute qualité.



**93073**



**93709**



### 93073 LUBERIO

pendant light; steel, chrome / glass, aluminium, clear, aluminium  
 Hängeleuchte; Stahl, chrom / Glas, Alu, klar, alu  
 luminaire en suspension; acier, chrome / verre, aluminium, clair, aluminium

H 1100, Ø 250



9 002759 930738



### 93709 MONTEFIO 1

pendant light; steel, chrome / glass, crystal, white, clear  
 Hängeleuchte; Stahl, chrom / Glas, Kristall, weiss, klar  
 luminaire en suspension; acier, chrome / verre, cristal, blanc, clair

H 1100, Ø 400



9 002759 937096

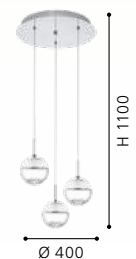



93708

LED



93784

LED

### 93708 MONTEFIO 1

pendant light; steel, chrome / glass, crystal, white, clear  
 Hängeleuchte; Stahl, chrom / Glas, Kristall, weiss, klar  
 luminaire en suspension; acier, chrome / verre, cristal, blanc, clair

H 1100, Ø 140



1x 5W  
 1x  
 480lm



9 002759 937089

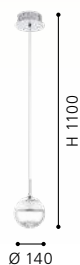

### 93784 MONTEFIO 1

pendant light; steel, chrome / glass, crystal, white, clear  
 Hängeleuchte; Stahl, chrom / Glas, Kristall, weiss, klar  
 luminaire en suspension; acier, chrome / verre, cristal, blanc, clair

L 870, B 140, H 1100



3x 5W  
 3x  
 480lm



9 002759 937843



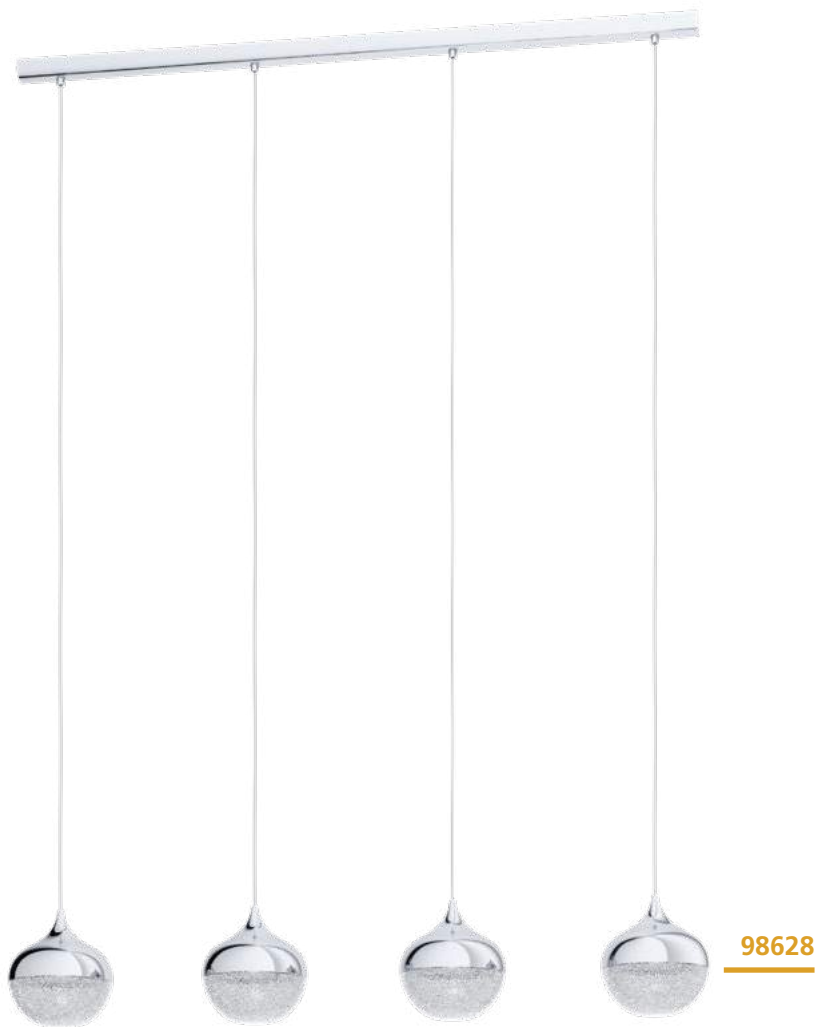

98628 | 98629

### 98628 MIOGLIA 1

pendant light; steel, chrome / plastic, granille white, clear  
 Hängeleuchte; Stahl, chrom / Kunststoff, granille weiss, klar  
 luminaire en suspension; acier, chrome / plastique, blanc granille, clair

L 975, B 150, H 1100



E14

4x 25W



9 002759 986285

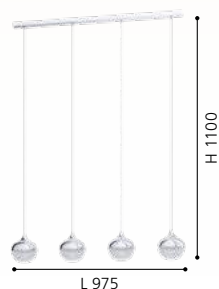

### 98629 MIOGLIA 1

pendant light; steel, chrome / plastic, granille white, clear  
 Hängeleuchte; Stahl, chrom / Kunststoff, granille weiss, klar  
 luminaire en suspension; acier, chrome / plastique, blanc granille, clair

H 1500, Ø 540



E14

5x 25W



9 002759 986292



### 95913 CONESSA

pendant light; steel, chrome / plastic, clear  
 Hängeleuchte; Stahl, chrom / Kunststoff, klar  
 luminaire en suspension; acier, chrome / plastique, clair

H 1100, Ø 290



GU10

3x 3W

warm WHITE

3x 250lm



9 002759 959135





95912

LED

95913

LED



95914

LED

### 95912 CONESSA

pendant light; steel, chrome / plastic, clear  
 Hängeleuchte; Stahl, chrom / Kunststoff, klar  
 luminaire en suspension; acier, chrome / plastique, clair

L 1010, B 150, H 1100



GU10



4x 3W



warm  
WHITE  
4x  
250lm

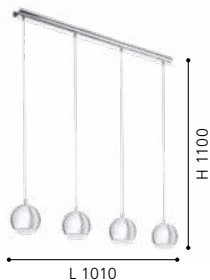

9 002759 959128



### 95914 CONESSA

pendant light; steel, chrome / plastic, clear  
 Hängeleuchte; Stahl, chrom / Kunststoff, klar  
 luminaire en suspension; acier, chrome / plastique, clair

H 1700, Ø 580



GU10



10x 3W



warm  
WHITE  
10x  
250lm



9 002759 959142





98678

LED



99107

LED

### 98678 ENALURI

pendant light; steel, satin nickel / plastic, satined  
 Hängeleuchte; Stahl, nickel-matt / Kunststoff, satiniert  
 luminaire en suspension; acier, nickel mat / plastique, satiné

L 140, B 105, H 1100





1x 5,4W      1x 630lm



9 002759 986780



### 99107 ENALURI

pendant light; steel, satin nickel / plastic, satined  
 Hängeleuchte; Stahl, nickel-matt / Kunststoff, satiniert  
 luminaire en suspension; acier, nickel mat / plastique, satiné

L 880, B 60, H 1100







4x 5,4W      4x 630lm

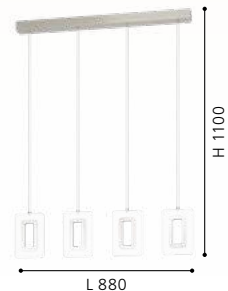

9 002759 991074



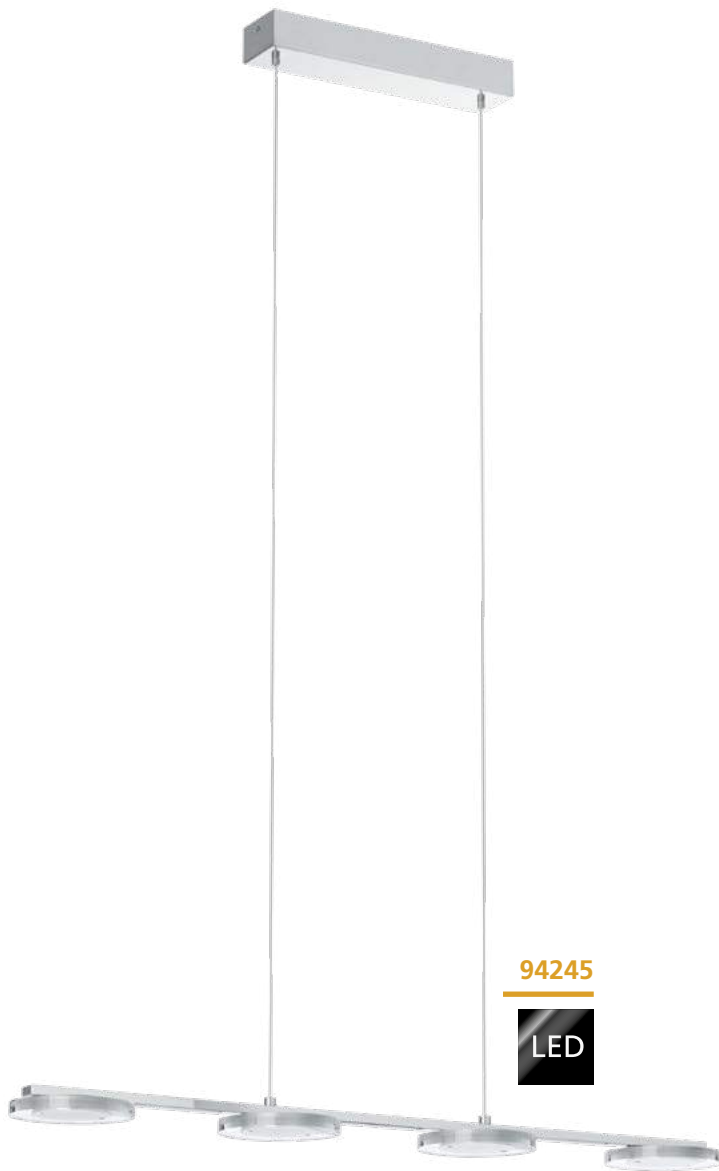



94245

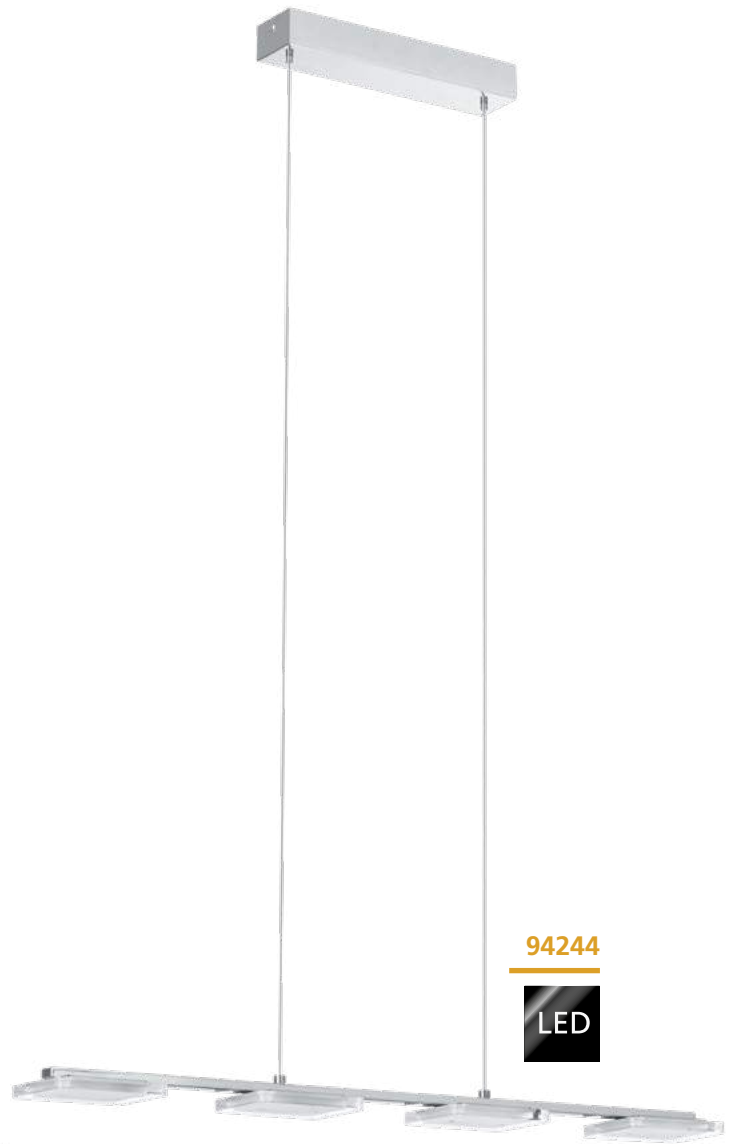

94244



### 94245 CARTAMA

pendant light; steel, chrome / plastic, clear, satined  
 Hängeleuchte; Stahl, chrom / Kunststoff, klar, satiniert  
 luminaire en suspension; acier, chrome / plastique, clair, satiné

L 775, B 115, H 1100



4x 4,5W  
 4x  
 480lm



9 002759 942458

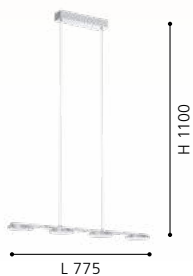

### 94244 CARTAMA

pendant light; steel, chrome / plastic, clear, satined  
 Hängeleuchte; Stahl, chrom / Kunststoff, klar, satiniert  
 luminaire en suspension; acier, chrome / plastique, clair, satiné

L 780, B 90, H 1100



4x 4,5W  
 4x  
 480lm



9 002759 942441

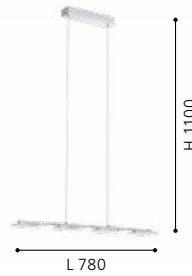



### 97366 MONTEFINO

pendant light; steel, black / glass, clear  
 Hängeleuchte; Stahl, schwarz / Glas, klar  
 luminaire en suspension; acier, noir / verre, clair

H 1100, Ø 110



E27 1x 60W



9 002759 973667

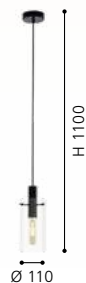

### 97367 MONTEFINO

pendant light; steel, black / glass, clear  
 Hängeleuchte; Stahl, schwarz / Glas, klar  
 luminaire en suspension; acier, noir / verre, clair

L 730, B 110, H 1100



E27 3x 60W



9 002759 973674



### 97368 MONTEFINO

pendant light; steel, black / glass, clear  
 Hängeleuchte; Stahl, schwarz / Glas, klar  
 luminaire en suspension; acier, noir / verre, clair

H 1500, Ø 350



E27 5x 60W



9 002759 973681





**97368**



98056

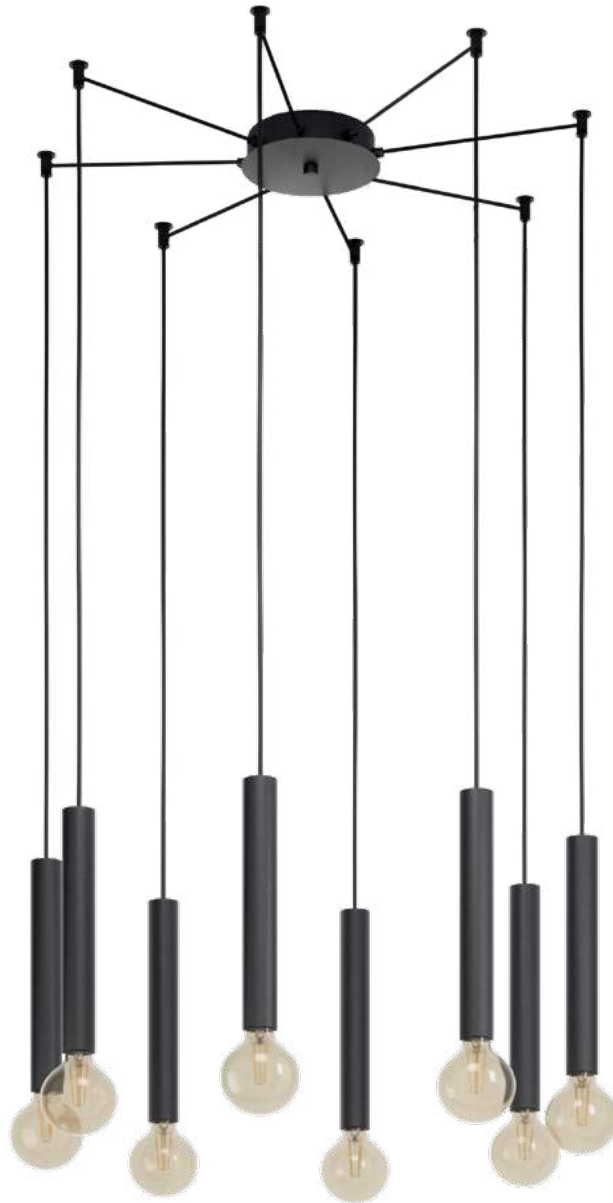

98083



98058

### 98056 CORTENOVA

pendant light; steel, black  
Hängeleuchte; Stahl, schwarz  
luminaire en suspension; acier, noir

H 1100, Ø 105

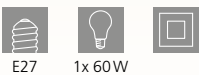

9 002759 980566



### 98083 CORTENOVA

pendant light; steel, black  
Hängeleuchte; Stahl, schwarz  
luminaire en suspension; acier, noir

H 2000, Ø 185

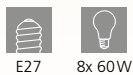

9 002759 980832



### 98058 CORTENOVA

pendant light; steel, black  
Hängeleuchte; Stahl, schwarz  
luminaire en suspension; acier, noir

H 1500, Ø 350



9 002759 980580





98057

### 98057 CORTENOVA

pendant light; steel, black  
Hängeleuchte; Stahl, schwarz  
luminaire en suspension; acier, noir

L 840, B 60, H 1100



E27



4x 60W



9 002759 980573







98661



98661 | 98662 | 98663



98663

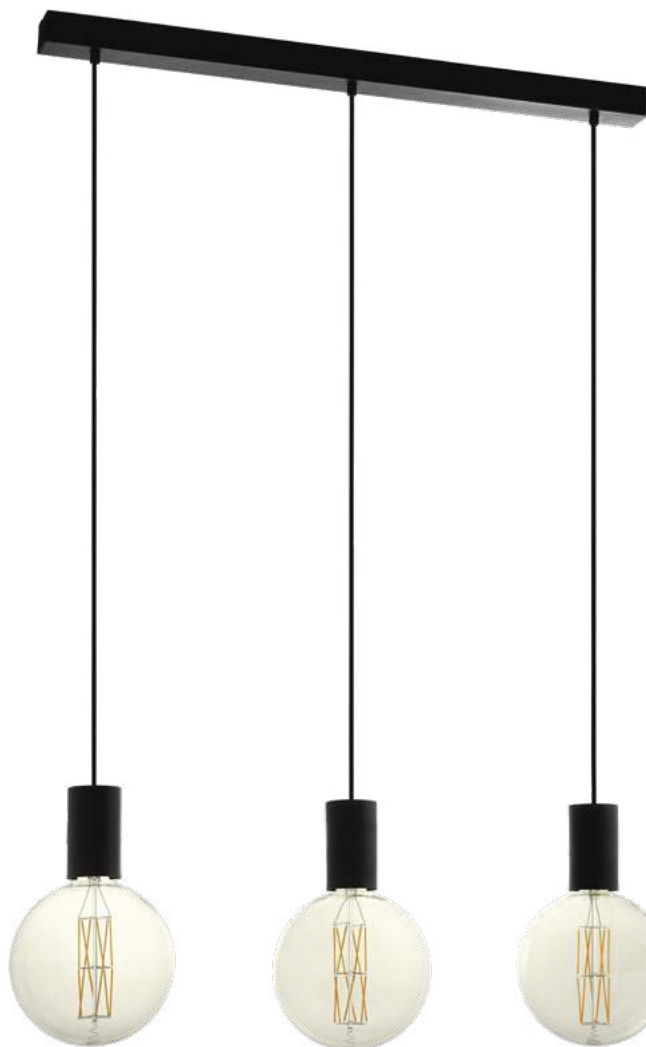

98662

### 98661 POZUETA

pendant light; steel, black  
Hängeleuchte; Stahl, schwarz  
luminaire en suspension; acier, noir

H 1100, Ø 125



E27 1x 40W



9 002759 986612

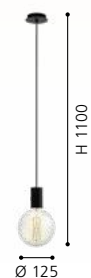

### 98663 POZUETA

pendant light; steel, black  
Hängeleuchte; Stahl, schwarz  
luminaire en suspension; acier, noir

H 1500, Ø 330



E27 3x 40W



9 002759 986636



### 98662 POZUETA

pendant light; steel, black  
Hängeleuchte; Stahl, schwarz  
luminaire en suspension; acier, noir

L 840, B 65, H 1100



E27 3x 40W



9 002759 986629





98346



98347

### 98346 BOCADELLA

pendant light; steel, black  
 Hängeleuchte; Stahl, schwarz  
 luminaire en suspension; acier, noir

H 1100, Ø 640



E27 9x 60W

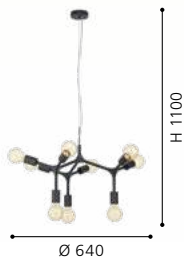

### 98347 BOCADELLA

pendant light; steel, black  
 Hängeleuchte; Stahl, schwarz  
 luminaire en suspension; acier, noir

H 1100, Ø 920



E27 12x 60W

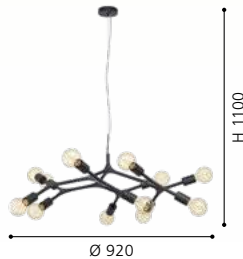

### 98909 MEZZANA

pendant light; steel, black  
 Hängeleuchte; Stahl, schwarz  
 luminaire en suspension; acier, noir

L 650, B 650, H 1100



E27 8x 40W

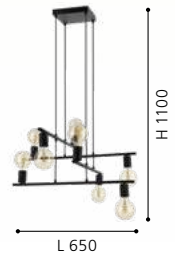



98909



98017



98016



99811

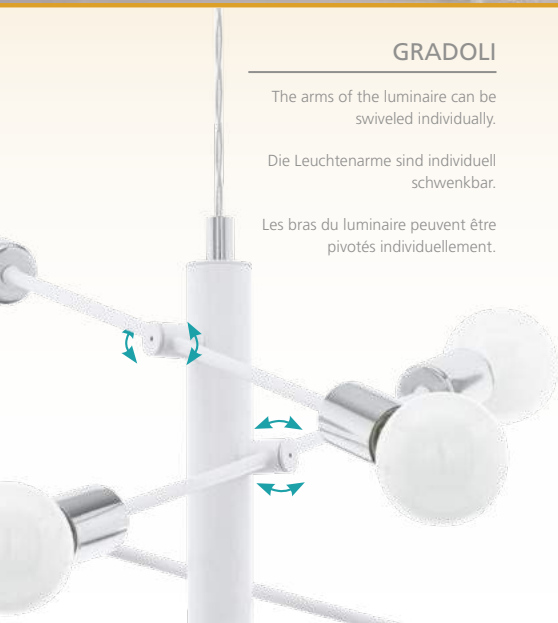

## GRADOLI

The arms of the luminaire can be swiveled individually.

Die Leuchtenarme sind individuell schwenkbar.

Les bras du luminaire peuvent être pivotés individuellement.

### 98017 GRADOLI

pendant light; steel, white, chrome  
Hängeleuchte; Stahl, weiss, chrom  
luminaire en suspension; acier, blanc, chrome

H 1100, Ø 710



9 002759 980177



### 98016 GRADOLI

pendant light; steel, white, chrome  
Hängeleuchte; Stahl, weiss, chrom  
luminaire en suspension; acier, blanc, chrome

H 1100, Ø 550

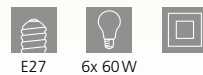

9 002759 980160

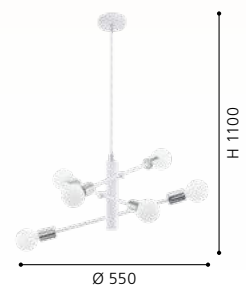





98835



98834 | 98835



98834

### 99811 GRADOLI 1

pendant light; steel, brushed brass  
Hängeleuchte; Stahl, messing-gebürstet  
luminaire en suspension; acier, laiton brossé

H 1100, Ø 710

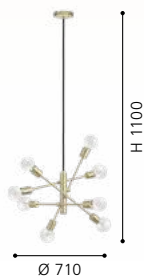
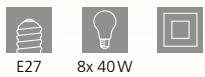

### 98835 MANIZALES

pendant light; steel, brushed brass  
Hängeleuchte; Stahl, messing-gebürstet  
luminaire en suspension; acier, laiton brossé

L 1010, B 50, H 1100

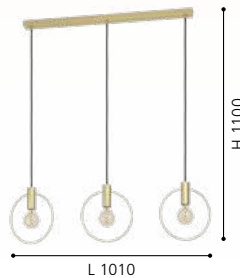
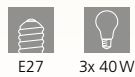

### 98834 MANIZALES

pendant light; steel, brushed brass  
Hängeleuchte; Stahl, messing-gebürstet  
luminaire en suspension; acier, laiton brossé

L 250, B 105, H 1100

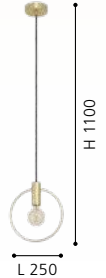



### 97734 MONTEBALDO

pendant light; steel, black, gold  
 Hängeleuchte; Stahl, schwarz, gold  
 luminaire en suspension; acier, noir, or

L 850, B 100, H 1100

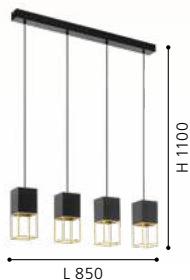
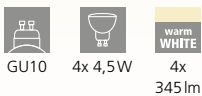

### 97733 MONTEBALDO

pendant light; steel, black, gold  
 Hängeleuchte; Stahl, schwarz, gold  
 luminaire en suspension; acier, noir, or

L 100, B 100, H 1100

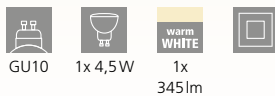

### 98858 BITACHITO

pendant light; steel, black, brass  
 Hängeleuchte; Stahl, schwarz, messing  
 luminaire en suspension; acier, noir, laiton

L 930, B 55, H 1100

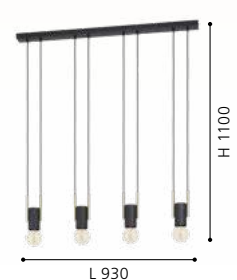

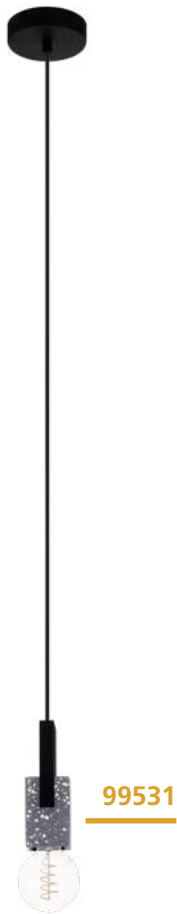

99531



99531 | 99532



99532

### 99531 LOBATIA

pendant light; steel, wood, black / terrazzo, grey, white  
 Hängeleuchte; Stahl, Holz, schwarz / Terrazzo, grau, weiss  
 luminaire en suspension; acier, bois, noir / terrazzo, gris, blanc

H 1100, Ø 105



E27 1x 40W



9 002759 995317



### 99532 LOBATIA

pendant light; steel, wood, black / terrazzo, grey, white  
 Hängeleuchte; Stahl, Holz, schwarz / Terrazzo, grau, weiss  
 luminaire en suspension; acier, bois, noir / terrazzo, gris, blanc

L 925, B 55, H 1100



E27 4x 40W



9 002759 995324



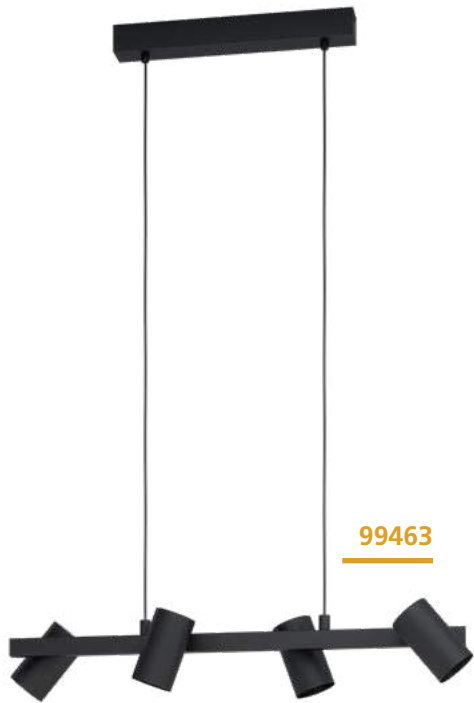

**99463**



**99464**

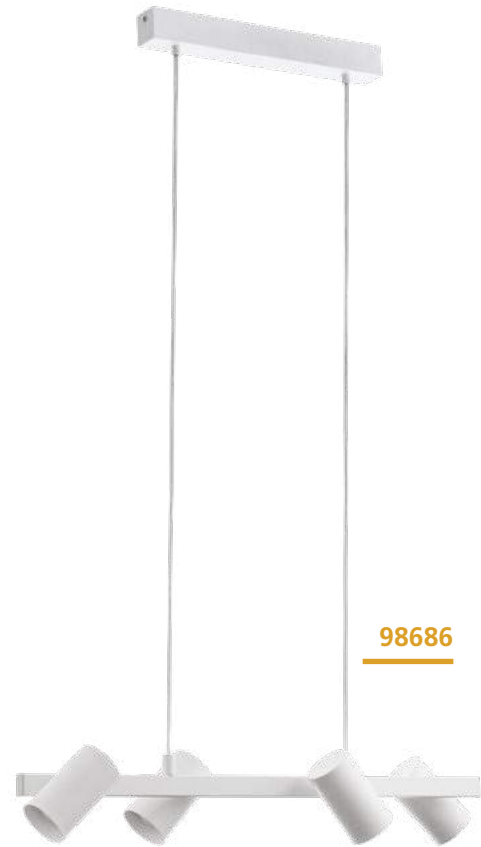

**98686**

### 99463 GATUELA 1

pendant light; steel, black  
Hängeleuchte; Stahl, schwarz  
luminaire en suspension; acier, noir

L 760, B 190, H 1100



E14

4x 25W



9 002759 994631



### 99464 GATUELA 1

pendant light; steel, black  
Hängeleuchte; Stahl, schwarz  
luminaire en suspension; acier, noir

L 1160, B 190, H 1100



E14

6x 25W



9 002759 994648

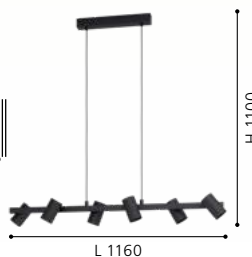

### 98686 GATUELA

pendant light; steel, white, satin nickel  
Hängeleuchte; Stahl, weiss, nickel-matt  
luminaire en suspension; acier, blanc, nickel mat

L 760, B 190, H 1100



E14

4x 25W



9 002759 986865

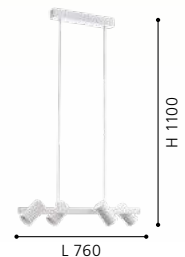



### 98687 GATUELA

pendant light; steel, white, satin nickel  
 Hängeleuchte; Stahl, weiss, nickel-matt  
 luminaire en suspension; acier, blanc, nickel mat

L 1160, B 190, H 1100

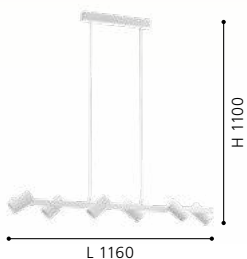

### 99819 ROVIRA

pendant light; aluminium, steel, silver / plastic, white  
 Hängeleuchte; Alu, Stahl, silber / Kunststoff, weiss  
 luminaire en suspension; aluminium, acier, argent / plastique, blanc

L 770, B 50, H 1100

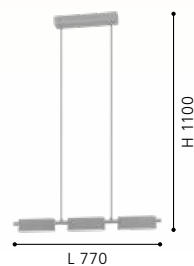

### 99821 ROVIRA

pendant light; aluminium, steel, black / plastic, white  
 Hängeleuchte; Alu, Stahl, schwarz / Kunststoff, weiss  
 luminaire en suspension; aluminium, acier, noir / plastique, blanc

L 770, B 50, H 1100

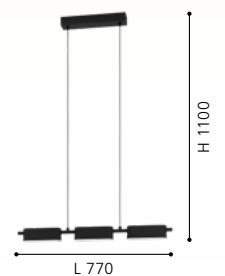





98441



EGLO  
RECOMMENDS  
**11595**

98192 | 98441

98192

### 98441 CAMARGO

pendant light; steel, black / glass opal-matt, white  
Hängeleuchte; Stahl, schwarz / Glas opal-matt, weiss  
luminaire en suspension; acier, noir / verre opale mat, blanc

H 1500, Ø 350



E14 3x 40W



9 002759 984410



### 98192 CAMARGO

pendant light; steel, black / glass opal-matt, white  
Hängeleuchte; Stahl, schwarz / Glas opal-matt, weiss  
luminaire en suspension; acier, noir / verre opale mat, blanc

L 350, B 200, H 1500



E27 1x 40W



9 002759 981921

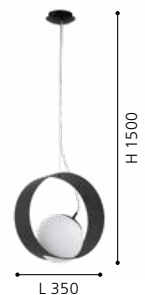



98681

LED



98682

LED

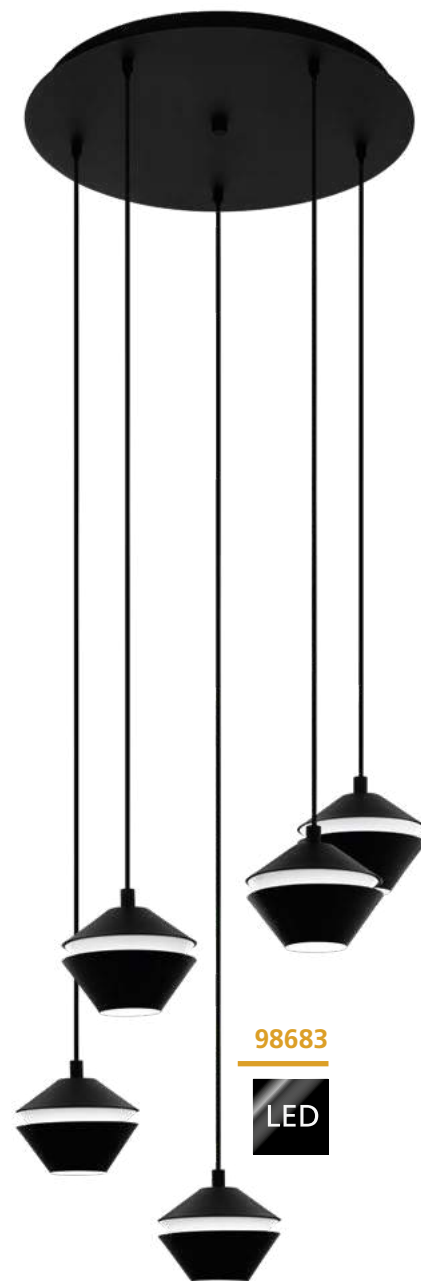

98683

LED

### 98681 PERPIGO

pendant light; steel, black / plastic, white  
 Hängeleuchte; Stahl, schwarz / Kunststoff, weiss  
 luminaire en suspension; acier, noir / plastique, blanc

H 1100, Ø 165

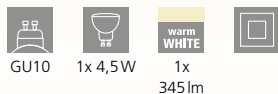

GU10 1x 4,5W 1x 345lm



9 002759 986810

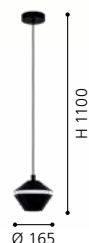

### 98682 PERPIGO

pendant light; steel, black / plastic, white  
 Hängeleuchte; Stahl, schwarz / Kunststoff, weiss  
 luminaire en suspension; acier, noir / plastique, blanc

L 865, B 165, H 1100



GU10 3x 4,5W 3x 345lm



9 002759 986827

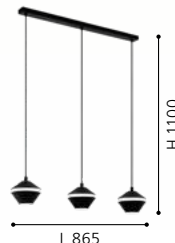

### 98683 PERPIGO

pendant light; steel, black / plastic, white  
 Hängeleuchte; Stahl, schwarz / Kunststoff, weiss  
 luminaire en suspension; acier, noir / plastique, blanc

H 1500, Ø 555

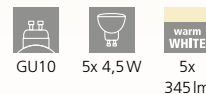

GU10 5x 4,5W 5x 345lm



9 002759 986834

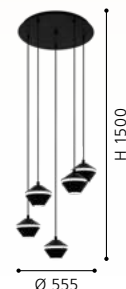



### 98492 AMONTILLADO

pendant light; aluminium, steel, black / plastic, white  
 Hängeleuchte; Alu, Stahl, schwarz / Kunststoff, weiss  
 luminaire en suspension; aluminium, acier, noir / plastique, blanc

L 1160, B 85, H 1100



27W 3500lm



9 002759 984922

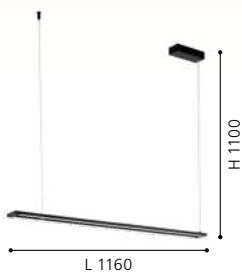

### 99599 CAMBULOS

pendant light; steel, black / plastic, white  
 Hängeleuchte; Stahl, schwarz / Kunststoff, weiss  
 luminaire en suspension; acier, noir / plastique, blanc

L 935, B 105, H 1100



2x 17W 4000lm



9 002759 995997



### 98495 SPADAFORA

pendant light; aluminium, steel, black / plastic, clear, white  
 Hängeleuchte; Alu, Stahl, schwarz / Kunststoff, klar, weiss  
 luminaire en suspension; aluminium, acier, noir / plastique, clair, blanc

L 1160, B 80, H 1100



14,5W 2050lm



9 002759 984953

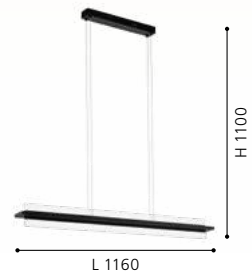



98836



### 98836 ERMUA

pendant light; steel, wood, black, brown / plastic, white  
Hängeleuchte; Stahl, Holz, schwarz, braun / Kunststoff, weiss  
luminaire en suspension; acier, bois, noir, marron / plastique, blanc

L 1000, B 165, H 1100



27W



3850lm



9 002759 988364

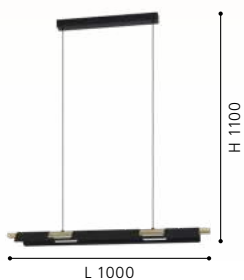

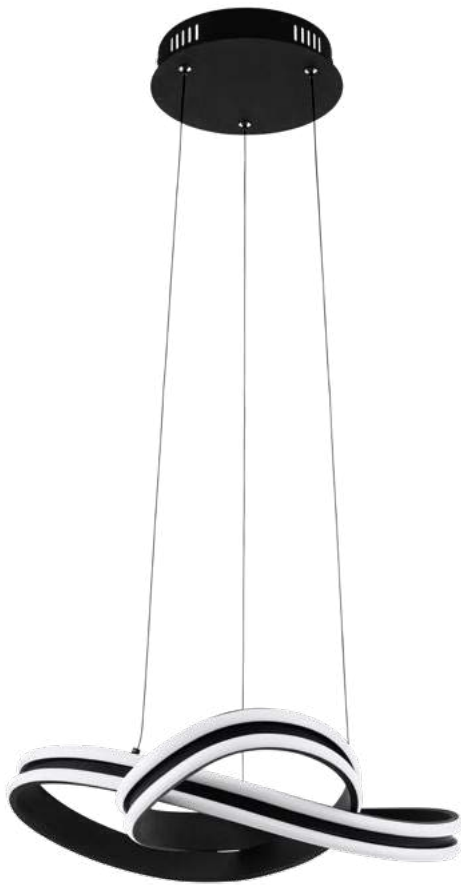

99249

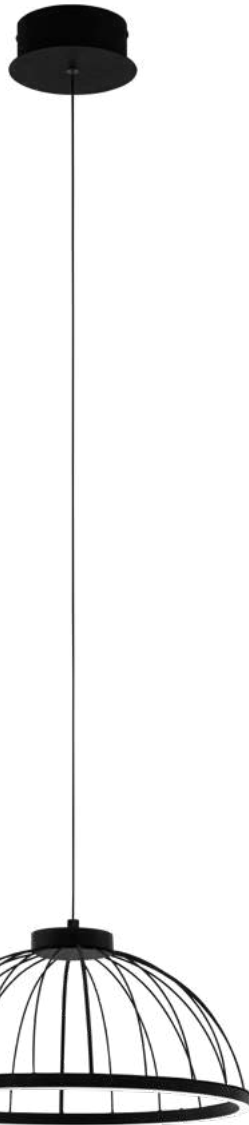

99401

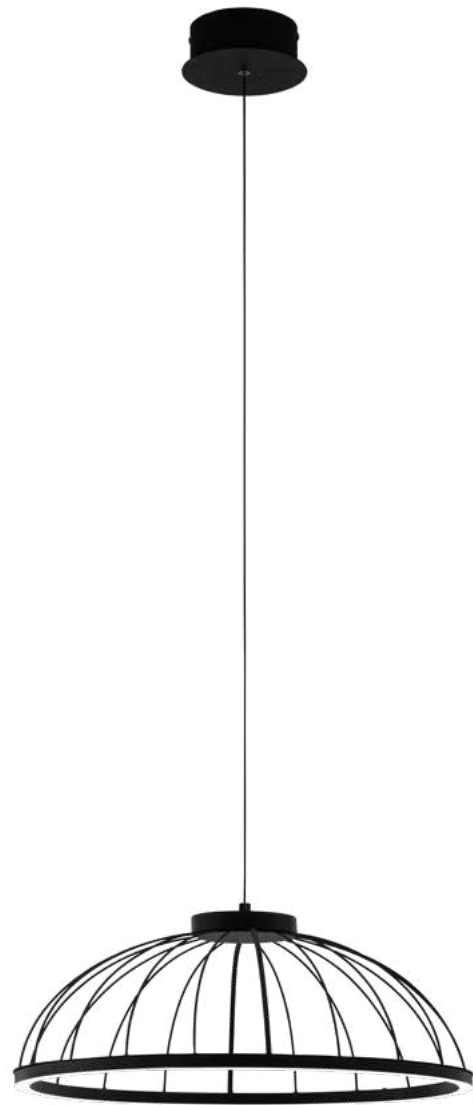

99403



### 99249 CORREDERA

pendant light; steel, black / plastic, white  
 Hängeleuchte; Stahl, schwarz / Kunststoff, weiss  
 luminaire en suspension; acier, noir / plastique, blanc

H 1200, Ø 500



2x 18W



2x 2500lm



9 002759 992491

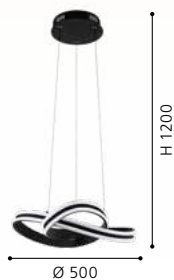

### 99401 BOGOTENILLO

pendant light; steel, black / plastic, white  
 Hängeleuchte; Stahl, schwarz / Kunststoff, weiss  
 luminaire en suspension; acier, noir / plastique, blanc

H 1200, Ø 400



22W



2750lm



9 002759 994013



### 99403 BOGOTENILLO

pendant light; steel, black / plastic, white  
 Hängeleuchte; Stahl, schwarz / Kunststoff, weiss  
 luminaire en suspension; acier, noir / plastique, blanc

H 1200, Ø 500



27W



3400lm



9 002759 994037







99358



99818



### 99358 CODRIALES

pendant light; steel, black / plastic, white  
 Hängeleuchte; Stahl, schwarz / Kunststoff, weiss  
 luminaire en suspension; acier, noir / plastique, blanc

L 780, B 300, H 1100



30W 3700lm



9 002759 993580



### 99818 SALITRE

pendant light; aluminium, black / plastic, white  
 Hängeleuchte; Alu, schwarz / Kunststoff, weiss  
 luminaire en suspension; aluminium, noir / plastique, blanc

H 1100, Ø 730



29W 4000lm



9 002759 998189

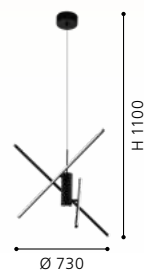



**99081**



**99082**

**99083**

99081 | 99082 | 99083

### 99081 VALECROSIA

pendant light; steel, black, white  
Hängeleuchte; Stahl, schwarz, weiss  
luminaire en suspension; acier, noir, blanc

H 1100, Ø 420

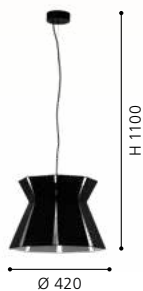

### 99082 VALECROSIA

pendant light; steel, black, white  
Hängeleuchte; Stahl, schwarz, weiss  
luminaire en suspension; acier, noir, blanc

L 180, B 180, H 1100



### 99083 VALECROSIA

pendant light; steel, black, white  
Hängeleuchte; Stahl, schwarz, weiss  
luminaire en suspension; acier, noir, blanc

L 840, B 180, H 1100

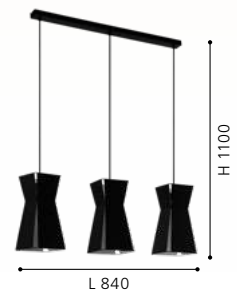

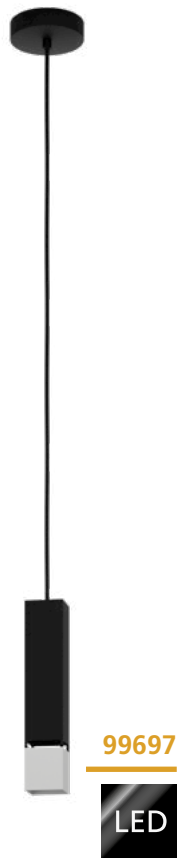

99697

LED



99698

LED

### 99697 BUTRANO

pendant light; steel, black, silver  
 Hängeleuchte; Stahl, schwarz, silber  
 luminaire en suspension; acier, noir, argent

L 55, B 55, H 1100

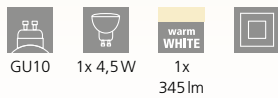

GU10 1x 4,5W 1x 345lm



### 99698 BUTRANO

pendant light; steel, black, silver  
 Hängeleuchte; Stahl, schwarz, silber  
 luminaire en suspension; acier, noir, argent

L 770, B 55, H 1100

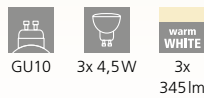

GU10 3x 4,5W 3x 345lm

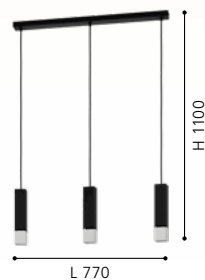



99073



99071

99072

### 99073 MIRTAZZA

pendant light; steel, black / steel, champagne  
Hängeleuchte; Stahl, schwarz / Stahl, champagner  
luminaire en suspension; acier, noir / acier, champagne

H 1100, Ø 590



9 002759 990732



### 99071 MIRTAZZA

pendant light; steel, black / steel, champagne  
Hängeleuchte; Stahl, schwarz / Stahl, champagner  
luminaire en suspension; acier, noir / acier, champagne

H 1100, Ø 180



9 002759 990718



### 99072 MIRTAZZA

pendant light; steel, black / steel, champagne  
Hängeleuchte; Stahl, schwarz / Stahl, champagner  
luminaire en suspension; acier, noir / acier, champagne

L 880, B 180, H 1100



9 002759 990725





98688



98689



97066

### 98688 OKINZURI

pendant light; steel, nickel-nero  
Hängeleuchte; Stahl, nickel-nero  
luminaire en suspension; acier, nickel noir

H 1100, Ø 450



E27 1x 60W



9 002759 986889



### 98689 OKINZURI

pendant light; steel, brass  
Hängeleuchte; Stahl, messing  
luminaire en suspension; acier, laiton

H 1100, Ø 450



E27 1x 60W



9 002759 986896



### 97066 ESTEVAU

pendant light; steel, dark brown  
Hängeleuchte; Stahl, dunkelbraun  
luminaire en suspension; acier, marron foncé

L 975, B 145, H 1100



E27 4x 60W



9 002759 970666







92251



92252



92251 | 92252 | 94388 | 94389

### 92251 RAZONI

pendant light; steel, white / satin glass, steel, white  
Hängeleuchte; Stahl, weiss / Glas satiniert, Stahl, weiss  
luminaire en suspension; acier, blanc / verre satiné, acier, blanc

H 1300, Ø 190



E27



1x 60W





### 92252 RAZONI

pendant light; steel, black / satin glass, steel, black, white  
 Hängeleuchte; Stahl, schwarz / Glas satiniert, Stahl, schwarz, weiss  
 luminaire en suspension; acier, noir / verre satiné, acier, noir, blanc

H 1300, Ø 190

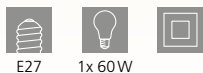

### 94388 RAZONI

pendant light; steel, white / satin glass, steel, white  
 Hängeleuchte; Stahl, weiss / Glas satiniert, Stahl, weiss  
 luminaire en suspension; acier, blanc / verre satiné, acier, blanc

L 990, B 190, H 1100



### 94389 RAZONI

pendant light; steel, black / satin glass, steel, black, white  
 Hängeleuchte; Stahl, schwarz / Glas satiniert, Stahl, schwarz, weiss  
 luminaire en suspension; acier, noir / verre satiné, acier, noir, blanc

L 990, B 190, H 1100

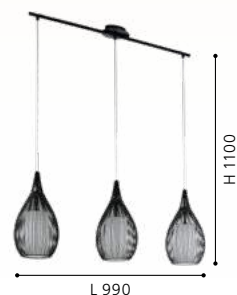



DESIGN  
HIGHLIGHT  
DETAIL

EGLO  
RECOMMENDS  
**11596**

99635 | 99636

99634

99636

**99634 MASETA**

pendant light; steel, black / smoked glass, black-transparent  
Hängeleuchte; Stahl, schwarz / Rauchglas, schwarz-transparent  
luminaire en suspension; acier, noir / verre fumé, noir transparent

L 930, B 225, H 1100



**99636 MASETA**

pendant light; steel, gold-coloured / glass opal-matt, white  
Hängeleuchte; Stahl, goldfarben / Glas opal-matt, weiss  
luminaire en suspension; acier, doré / verre opale mat, blanc

L 930, B 225, H 1100



**99633 MASETA**

pendant light; steel, black / smoked glass, black-transparent  
Hängeleuchte; Stahl, schwarz / Rauchglas, schwarz-transparent  
luminaire en suspension; acier, noir / verre fumé, noir transparent

H 1100, Ø 225

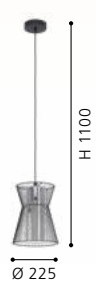

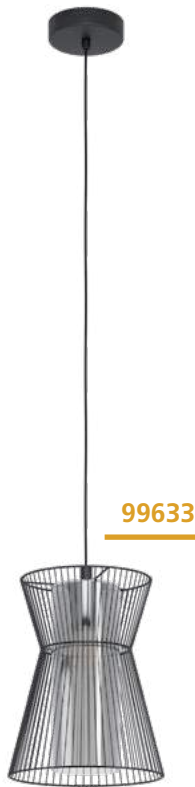

99633



99633 | 99634



99635

### 99635 MASETA

pendant light; steel, gold-coloured / glass opal-matt, white  
 Hängeleuchte; Stahl, goldfarben / Glas opal-matt, weiss  
 luminaire en suspension; acier, doré / verre opale mat, blanc

H 1100, Ø 225



E27 1x 40W







### 99705 FLORESTA

pendant light; steel, black / glass vaporized, black-transparent  
 Hängeleuchte; Stahl, schwarz / Glas bedampft, schwarz-transparent  
 luminaire en suspension; acier, noir / verre vaporisé, noir transparent

H 1100, Ø 195

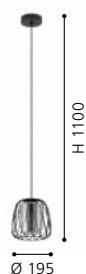

### 99706 FLORESTA

pendant light; steel, black / glass vaporized, black-transparent  
 Hängeleuchte; Stahl, schwarz / Glas bedampft, schwarz-transparent  
 luminaire en suspension; acier, noir / verre vaporisé, noir transparent

L 890, B 190, H 1100

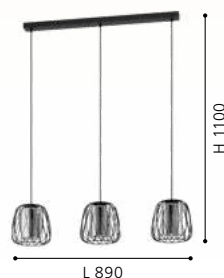

### 99707 ZOCABON

pendant light; steel, black / glass, clear  
 Hängeleuchte; Stahl, schwarz / Glas, klar  
 luminaire en suspension; acier, noir / verre, clair

L 815, B 110, H 1100







99619



99618

### 99619 MULEGES

pendant light; steel, black / glass opal-matt, white  
 Hängeleuchte; Stahl, schwarz / Glas opal-matt, weiss  
 luminaire en suspension; acier, noir / verre opale mat, blanc

L 960, B 160, H 1100



### 99618 MULEGES

pendant light; steel, black / glass opal-matt, white  
 Hängeleuchte; Stahl, schwarz / Glas opal-matt, weiss  
 luminaire en suspension; acier, noir / verre opale mat, blanc

H 1100, Ø 160

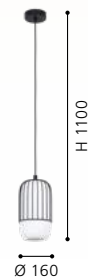



99661



99662

### 99661 CURASAO

pendant light; steel, black / steel, fabric, black, gold  
 Hängeleuchte; Stahl, schwarz / Stahl, Textil, schwarz, gold  
 luminaire en suspension; acier, noir / acier, tissu, noir, or

H 1100, Ø 335



E27 1x 40W



9 002759 996611



### 99662 CURASAO

pendant light; steel, black / steel, fabric, black, gold  
 Hängeleuchte; Stahl, schwarz / Stahl, Textil, schwarz, gold  
 luminaire en suspension; acier, noir / acier, tissu, noir, or

L 995, B 235, H 1100



E27 3x 40W



9 002759 996628



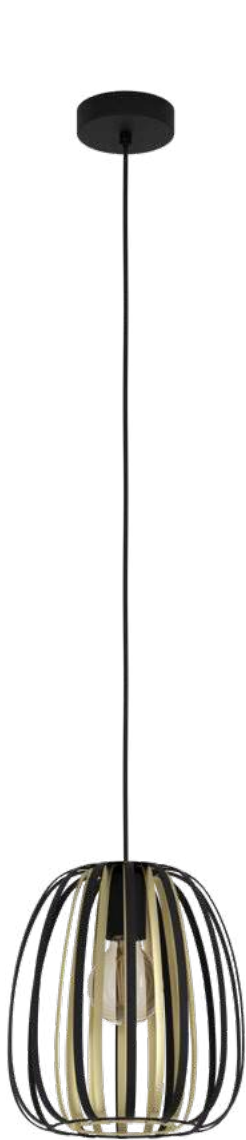

99665

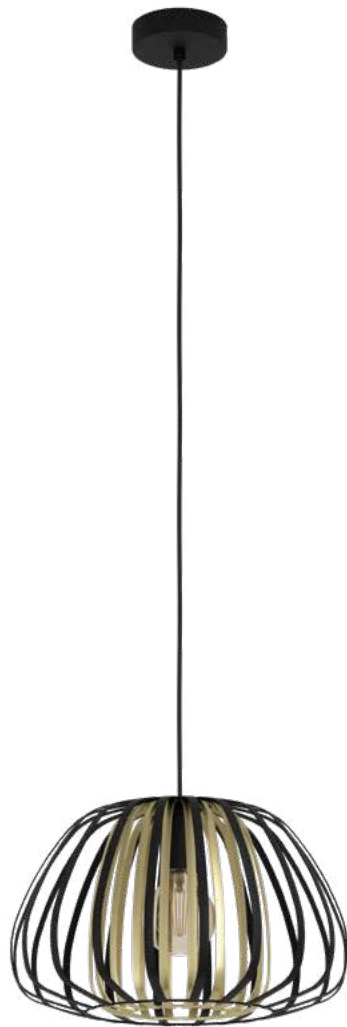

99666



### 99665 ENCINITOS

pendant light; steel, black, gold  
Hängeleuchte; Stahl, schwarz, gold  
luminaire en suspension; acier, noir, or

H 1100, Ø 255



E27 1x 40W



9 002759 996659



### 99666 ENCINITOS

pendant light; steel, black, gold  
Hängeleuchte; Stahl, schwarz, gold  
luminaire en suspension; acier, noir, or

H 1100, Ø 375



E27 1x 40W



9 002759 996666





**99694**

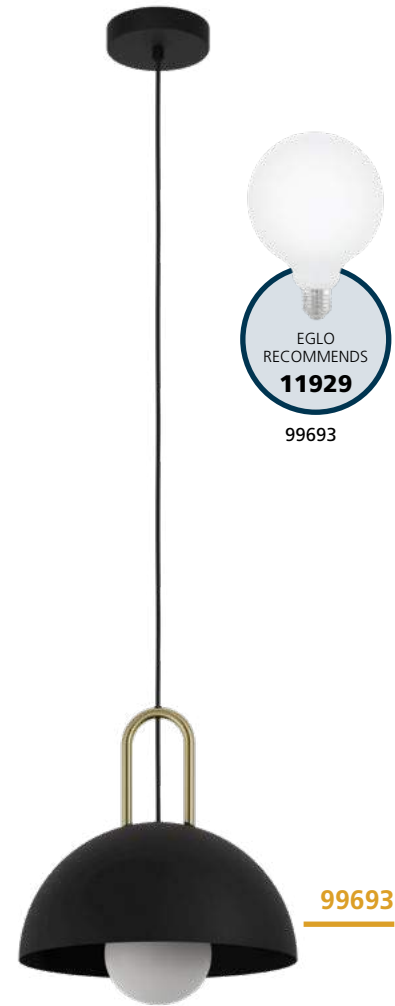

**99693**

**99694 CALMANERA**

pendant light; steel, black, brass  
 Hängeleuchte; Stahl, schwarz, messing  
 luminaire en suspension; acier, noir, laiton

L 900, B 200, H 1100



**99693 CALMANERA**

pendant light; steel, black, brass  
 Hängeleuchte; Stahl, schwarz, messing  
 luminaire en suspension; acier, noir, laiton

H 1100, Ø 325

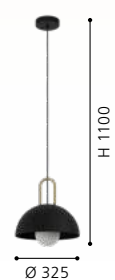



99695 | 99696

99696

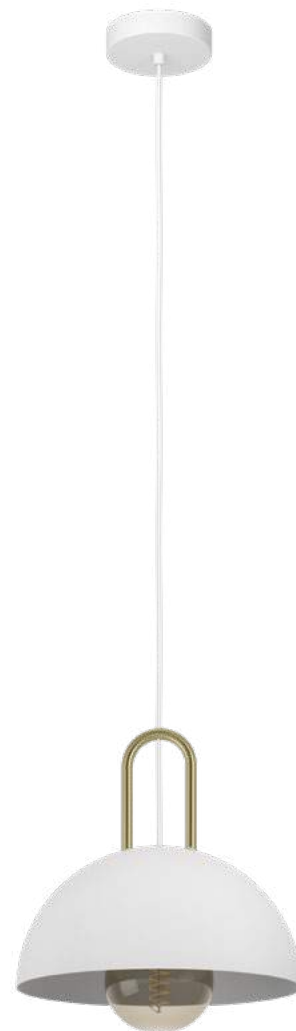

99695

### 99696 CALMANERA

pendant light; steel, white, brass  
 Hängeleuchte; Stahl, weiss, messing  
 luminaire en suspension; acier, blanc, laiton

L 900, B 200, H 1100



9 002759 996963

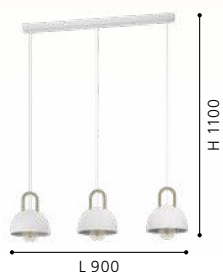

### 99695 CALMANERA

pendant light; steel, white, brass  
 Hängeleuchte; Stahl, weiss, messing  
 luminaire en suspension; acier, blanc, laiton

H 1100, Ø 325



9 002759 996956

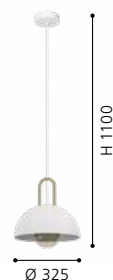





DESIGN  
HIGHLIGHT  
DETAIL



98839



### 98839 LOSALOMAS

pendant light; steel, Mokka colour, brushed brass  
Hängeleuchte; Stahl, Mokkafarben, messing-gebürstet  
luminaire en suspension; acier, mocha couleur, laiton brossé

L 835, B 135, H 1100

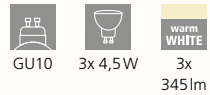

### 98838 LOSALOMAS

pendant light; steel, Mokka colour, brushed brass  
Hängeleuchte; Stahl, Mokkafarben, messing-gebürstet  
luminaire en suspension; acier, mocha couleur, laiton brossé

H 1100, Ø 135

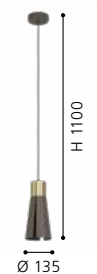
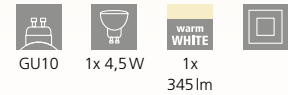



98838

LED



99439





99438



### 99439 SEGEZIA

pendant light; steel, Mokka colour / steel, Mokka colour, gold  
 Hängeleuchte; Stahl, Mokkafarben / Stahl, Mokka, gold  
 luminaire en suspension; acier, mocha couleur / acier, Mokka, or

H 1100, Ø 350



### 99438 SEGEZIA

pendant light; steel, Mokka colour / steel, Mokka colour, gold  
 Hängeleuchte; Stahl, Mokkafarben / Stahl, Mokka, gold  
 luminaire en suspension; acier, mocha couleur / acier, Mokka, or

L 880, B 180, H 1100





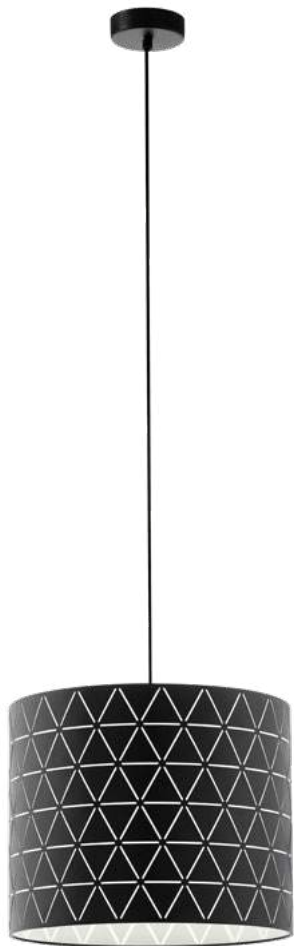

98351

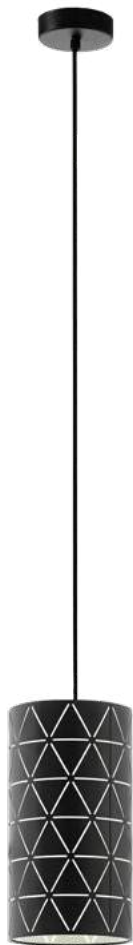

98352



98353

### 98351 RAMON

pendant light; steel, black / film, white  
Hängeleuchte; Stahl, schwarz / Folie, weiss  
luminaire en suspension; acier, noir / film, blanc

H 1100, Ø 370



9 002759 983512

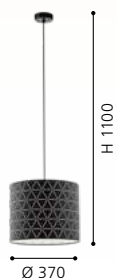

### 98352 RAMON

pendant light; steel, black / film, white  
Hängeleuchte; Stahl, schwarz / Folie, weiss  
luminaire en suspension; acier, noir / film, blanc

H 1100, Ø 160



9 002759 983529

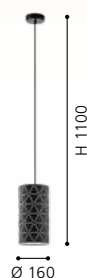

### 98353 RAMON

pendant light; steel, black / film, white  
Hängeleuchte; Stahl, schwarz / Folie, weiss  
luminaire en suspension; acier, noir / film, blanc

L 860, B 160, H 1100



9 002759 983536

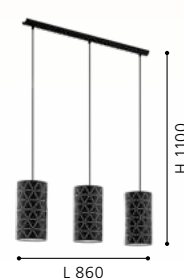





98456



98071

### 98456 CANTALLOPS

pendant light; steel, black  
 Hängeleuchte; Stahl, schwarz  
 luminaire en suspension; acier, noir

L 1150, B 520, H 1100



E14 6x 40W



9 002759 984564

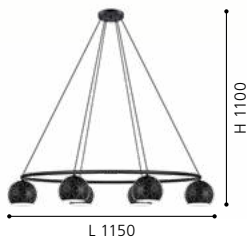

### 98071 CAMASTRA

pendant light; steel, black, gold  
 Hängeleuchte; Stahl, schwarz, gold  
 luminaire en suspension; acier, noir, or

H 1100, Ø 225



E27 1x 40W



9 002759 980719

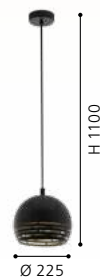

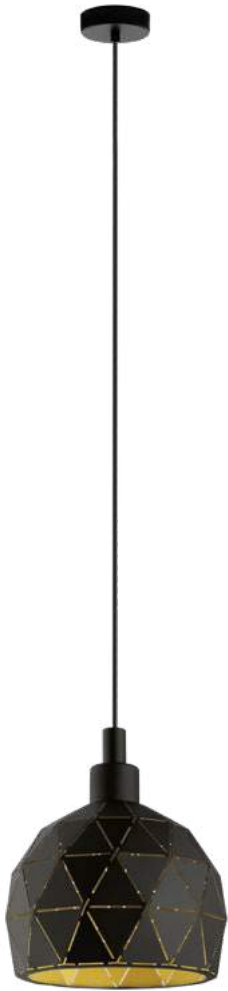

33345



97845



97841

### 33345 ROCCAFORTE

pendant light; steel, black, gold  
Hängeleuchte; Stahl, schwarz, gold  
luminaire en suspension; acier, noir, or

H 1100, Ø 170



E14 1x 40W



9 002759 333454

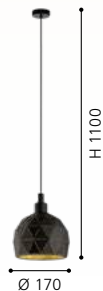

### 97845 ROCCAFORTE

pendant light; steel, black, gold  
Hängeleuchte; Stahl, schwarz, gold  
luminaire en suspension; acier, noir, or

H 1100, Ø 300



E27 1x 60W



9 002759 978457



### 97841 ROCCAFORTE

pendant light; steel, black, gold  
Hängeleuchte; Stahl, schwarz, gold  
luminaire en suspension; acier, noir, or

H 1100, Ø 400



E27 1x 60W



9 002759 978419





**97846**

### 97846 ROCCAFORTE

pendant light; steel, black, gold  
Hängeleuchte; Stahl, schwarz, gold  
luminaire en suspension; acier, noir, or

L 750, B 170, H 1100



E14



3x 40W



9 002759 978464

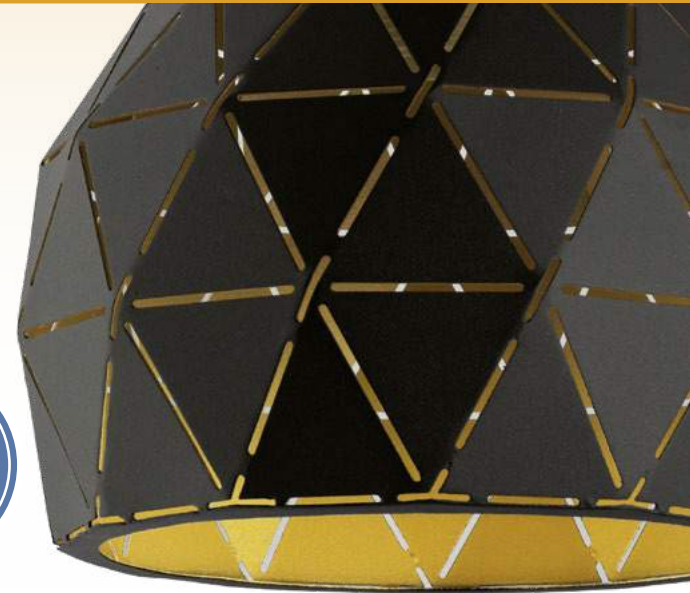
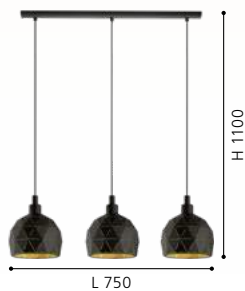





33344



97854

### 33344 ROCCAFORTE

pendant light; steel, white  
Hängeleuchte; Stahl, weiss  
luminaire en suspension; acier, blanc

H 1100, Ø 170



E14



1x 40W



9 002759 333447

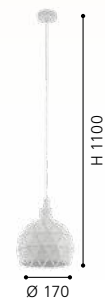



97855



97857

### 97854 ROCCAFORTE

pendant light; steel, white  
Hängeleuchte; Stahl, weiss  
luminaire en suspension; acier, blanc

H 1100, Ø 300



E27 1x 60W



9 002759 978549



Ø 300

H 1100, Ø 400

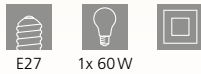

E27 1x 60W



9 002759 978556



Ø 400

### 97857 ROCCAFORTE

pendant light; steel, white  
Hängeleuchte; Stahl, weiss  
luminaire en suspension; acier, blanc

L 750, B 170, H 1100

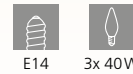

E14 3x 40W



9 002759 978570

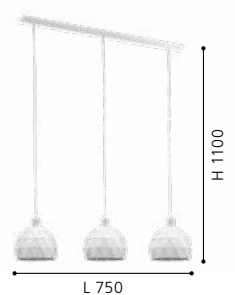

L 750





93373



93374



### 93373 CAMPILO

pendant light; plastic, white / paper threads, white  
 Hängeleuchte; Kunststoff, weiss / Papierfäden, weiss  
 luminaire en suspension; plastique, blanc / fils de papier, blanc

H 1100, Ø 450

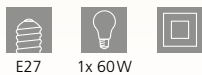

9 002759 933739



### 93374 CAMPILO

pendant light; plastic, white / paper threads, beige  
 Hängeleuchte; Kunststoff, weiss / Papierfäden, beige  
 luminaire en suspension; plastique, blanc / fils de papier, beige

H 1100, Ø 450



9 002759 933746

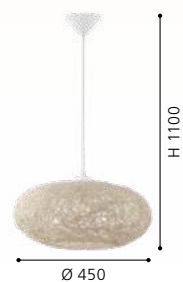



95385



95383



95384

### 95385 OBREGON

pendant light; steel, brown, creme, oak  
 Hängeleuchte; Stahl, braun, creme, eiche  
 luminaire en suspension; acier, marron, crème, chêne

H 1100, Ø 350



9 002759 953850

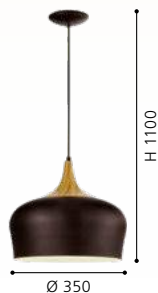

### 95383 OBREGON

pendant light; steel, creme, oak  
 Hängeleuchte; Stahl, creme, eiche  
 luminaire en suspension; acier, crème, chêne

H 1100, Ø 350



9 002759 953836



### 95384 OBREGON

pendant light; steel, white, chrome  
 Hängeleuchte; Stahl, weiss, chrom  
 luminaire en suspension; acier, blanc, chrome

H 1100, Ø 350



9 002759 953843



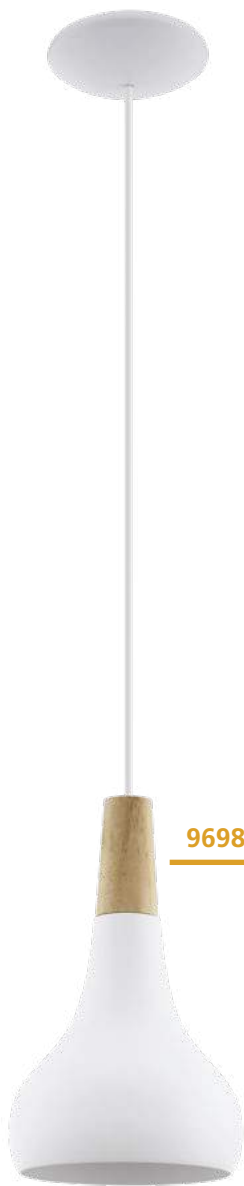

96981



96982



96983

### 96981 SABINAR

pendant light; steel, white / wood, brown  
Hängeleuchte; Stahl, weiss / Holz, braun  
luminaire en suspension; acier, blanc / bois, marron

H 1100, Ø 180



9 002759 969813



### 96982 SABINAR

pendant light; steel, white / wood, brown  
Hängeleuchte; Stahl, weiss / Holz, braun  
luminaire en suspension; acier, blanc / bois, marron

H 1100, Ø 280

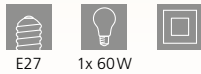

9 002759 969820



### 96983 SABINAR

pendant light; steel, white / wood, brown  
Hängeleuchte; Stahl, weiss / Holz, braun  
luminaire en suspension; acier, blanc / bois, marron

H 1100, Ø 400



9 002759 969837



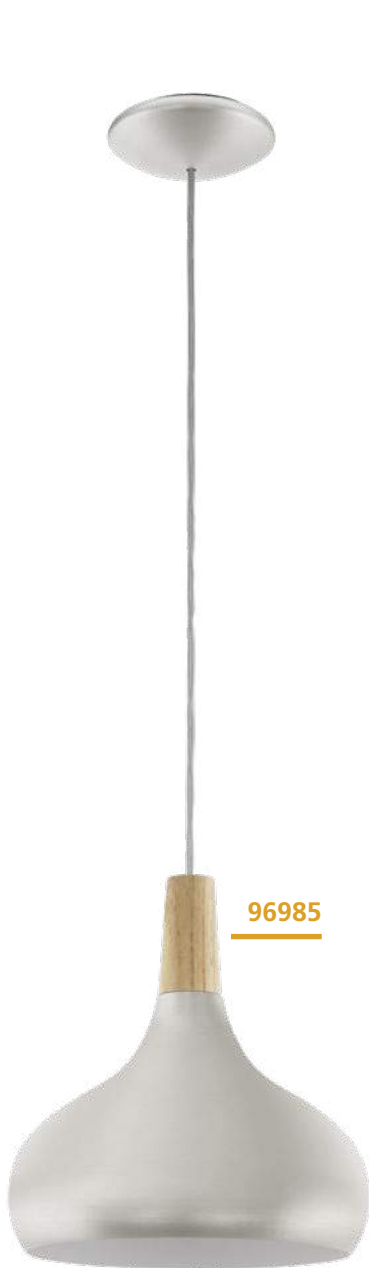

96985



96986



### 96985 SABINAR

pendant light; steel, brushed silver / wood, brown  
 Hängeleuchte; Stahl, silber gebürstet / Holz, braun  
 luminaire en suspension; acier, argent brossé / bois, marron

H 1100, Ø 280



9 002759 969851

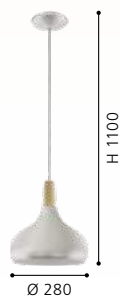

### 96986 SABINAR

pendant light; steel, brushed silver / wood, brown  
 Hängeleuchte; Stahl, silber gebürstet / Holz, braun  
 luminaire en suspension; acier, argent brossé / bois, marron

H 1100, Ø 400



9 002759 969868





### 98591 CASTRALVO

pendant light; steel, wood, satin nickel, brown / fabric, white  
 Hängeleuchte; Stahl, Holz, nickel-matt, braun / Textil, weiss  
 luminaire en suspension; acier, bois, nickel mat, marron / tissu, blanc

L 1210, B 150, H 1100



E27 5x 28W



9 002759 985912

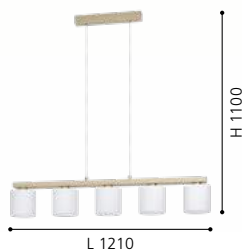

### 98592 CASTRALVO

pendant light; steel, wood, satin nickel, brown / glass vaporized, amber  
 Hängeleuchte; Stahl, Holz, nickel-matt, braun / Glas bedampft, amber  
 luminaire en suspension; acier, bois, nickel mat, marron / verre vaporisé, ambre

luminaire en suspension; acier, bois, nickel mat, marron / verre vaporisé, ambre

L 1210, B 150, H 1100



E27 5x 28W



9 002759 985929

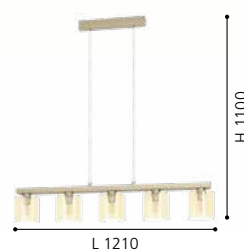





99701



99702

### 99701 VIGLIONI

pendant light; steel, wood, black, brown / glass vaporized, black-transparent

Hängeleuchte; Stahl, Holz, schwarz, braun / Glas bedampft, schwarz-transparent

luminaire en suspension; acier, bois, noir, marron / verre vaporisé, noir transparent

L 230, B 165, H 1100



E27



1x 40W



9 002759 997014

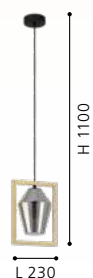

L 230

### 99702 VIGLIONI

pendant light; steel, wood, black, brown / glass vaporized, black-transparent

Hängeleuchte; Stahl, Holz, schwarz, braun / Glas bedampft, schwarz-transparent

luminaire en suspension; acier, bois, noir, marron / verre vaporisé, noir transparent

L 1060, B 165, H 1100



E27



3x 40W



9 002759 997021

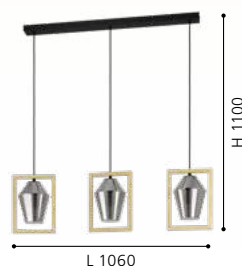

L 1060



**95755**



**94935**



**94936**

### 95755 NUVANO

pendant light; steel, brown, gold  
Hängeleuchte; Stahl, braun, gold  
luminaire en suspension; acier, marron, or

H 1100, Ø 480



E27

1x 60W



9 002759 957551



### 94935 GAETANO 1

pendant light; steel, black, gold  
Hängeleuchte; Stahl, schwarz, gold  
luminaire en suspension; acier, noir, or

H 1500, Ø 380



E27

1x 60W



9 002759 949358



### 94936 GAETANO 1

pendant light; steel, black, gold  
Hängeleuchte; Stahl, schwarz, gold  
luminaire en suspension; acier, noir, or

H 1500, Ø 530



E27

1x 60W



9 002759 949365





99663

LED

### 99663 NUVANO

pendant light; steel, black, gold  
 Hängeleuchte; Stahl, schwarz, gold  
 luminaire en suspension; acier, noir, or

L 985, B 225, H 1100



GU10



3x 4,5W



3x

345 lm

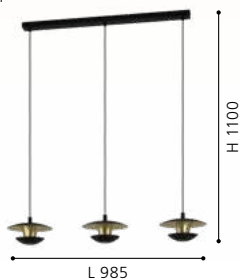

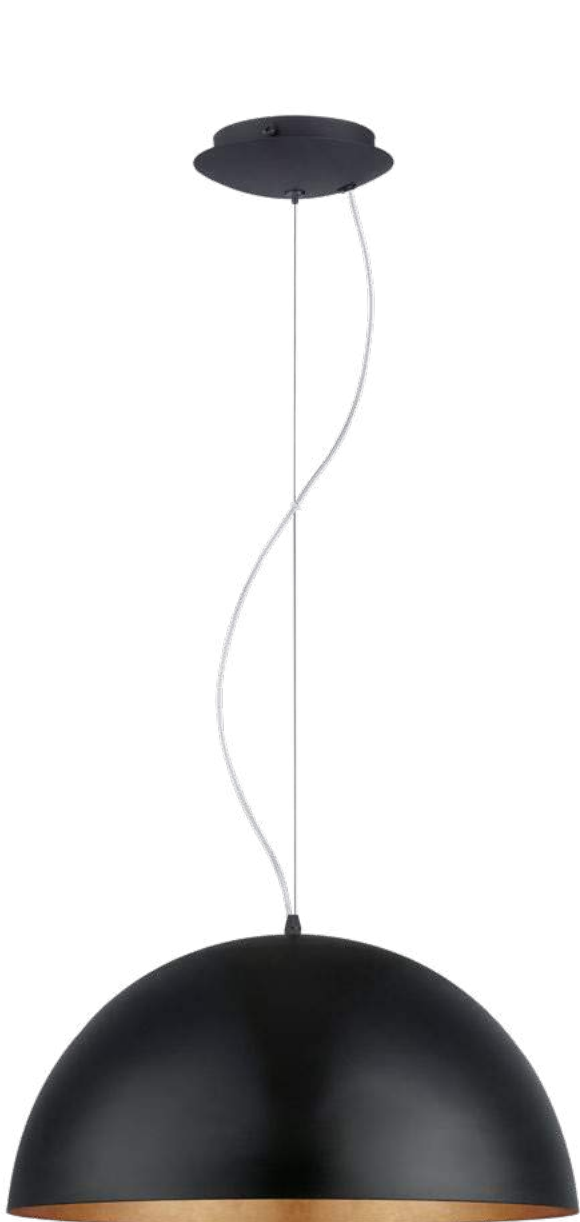

**94938**

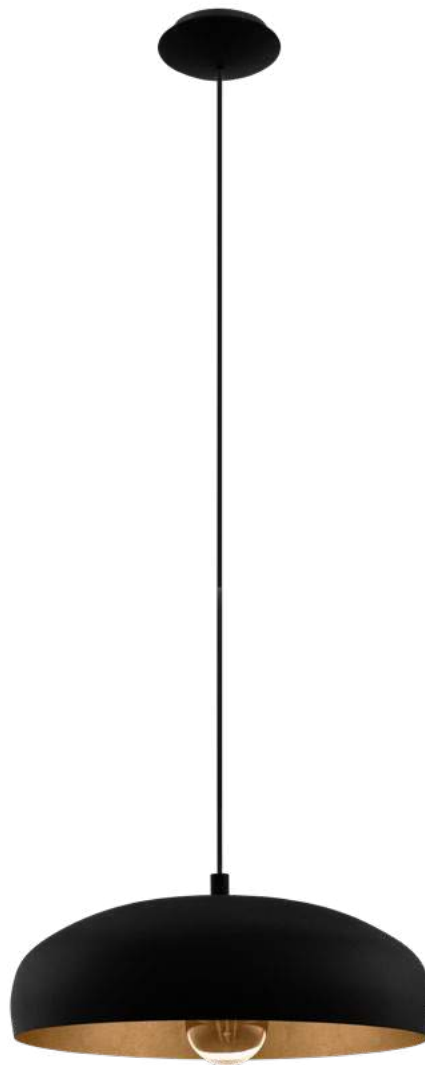

**94605**



**94606**

### 94938 GAETANO 1

pendant light; steel, black, copper  
 Hängeleuchte; Stahl, schwarz, kupfer  
 luminaire en suspension; acier, noir, cuivre

H 1500, Ø 530



9 002759 949389



### 94605 MOGANO 1

pendant light; steel, black, copper  
 Hängeleuchte; Stahl, schwarz, kupfer  
 luminaire en suspension; acier, noir, cuivre

H 1100, Ø 400



9 002759 946050

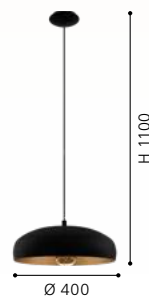

### 94606 MOGANO 1

pendant light; steel, white, copper  
 Hängeleuchte; Stahl, weiss, kupfer  
 luminaire en suspension; acier, blanc, cuivre

H 1100, Ø 400



9 002759 946067

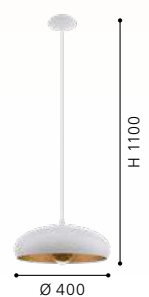



87055



31666

### 87055 BRENDA

pendant light; plastic, steel, white, chrome / steel, white  
 Hängeleuchte; Kunststoff, Stahl, weiss, chrom / Stahl, weiss  
 luminaire en suspension; plastique, acier, blanc, chrome / acier, blanc

H 1300, Ø 430



E27 1x 60W



9 002759 870553

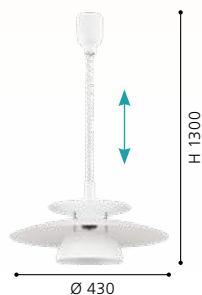

### 31666 BRENDA

pendant light; plastic, steel, black / steel, black, copper  
 Hängeleuchte; Kunststoff, Stahl, schwarz / Stahl, schwarz, kupfer  
 luminaire en suspension; plastique, acier, noir / acier, noir, cuivre

H 1100, Ø 430



E27 1x 60W



9 002759 316662

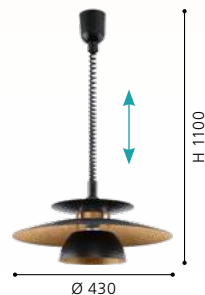

### BRENDA

This luminaires are flexible in height thanks to the spiral cables.

Diese Leuchten sind durch die Spiralkabel in der Höhe verstellbar.

La hauteur de ces lumières peut être ajustée à l'aide du câble en spirale.







**98735**



**99451**

**98734**

**98735 BRENDA**

pendant light; steel, black, satin nickel  
 Hängeleuchte; Stahl, schwarz, nickel-matt  
 luminaire en suspension; acier, noir, nickel mat

H 1500, Ø 320



9 002759 987350

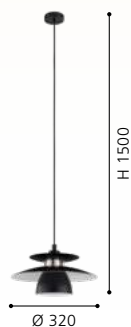

**98734 BRENDA**

pendant light; steel, white, satin nickel  
 Hängeleuchte; Stahl, weiss, nickel-matt  
 luminaire en suspension; acier, blanc, nickel mat

H 1500, Ø 320



9 002759 987343



**99451 GAETANO 1**

pendant light; steel, black, grey  
 Hängeleuchte; Stahl, schwarz, grau  
 luminaire en suspension; acier, noir, gris

H 1100, Ø 380



9 002759 994518

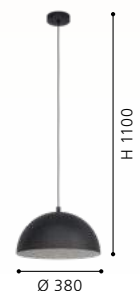

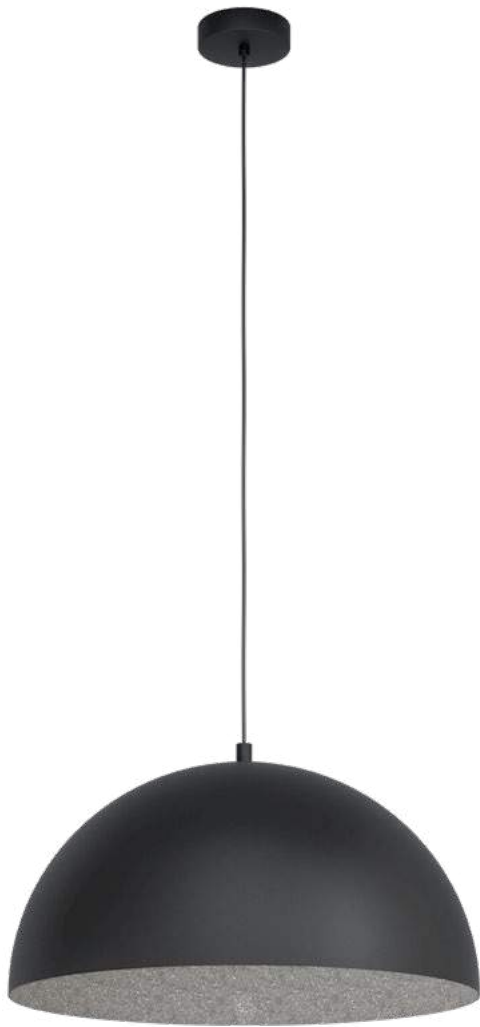

99452

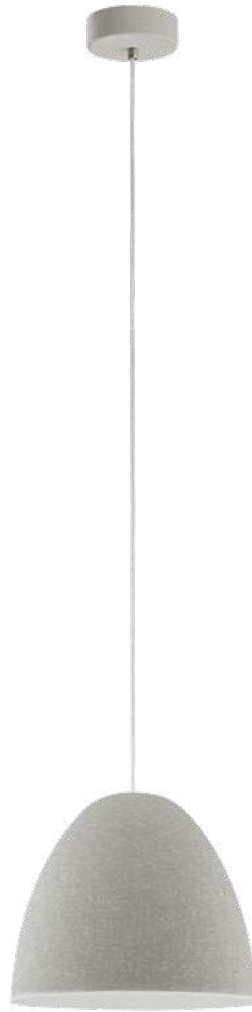

94353

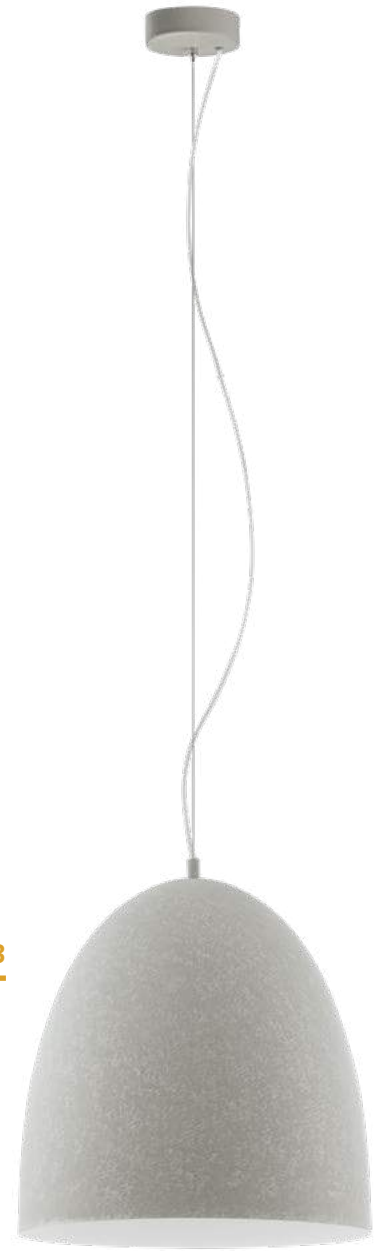

94354

### 99452 GAETANO 1

pendant light; steel, black, grey  
Hängeleuchte; Stahl, schwarz, grau  
luminaire en suspension; acier, noir, gris

H 1100, Ø 530



E27 1x 40W



9 002759 994525



### 94353 SARABIA

pendant light; steel, grey  
Hängeleuchte; Stahl, grau  
luminaire en suspension; acier, gris

H 1100, Ø 275



E27 1x 60W



9 002759 943530

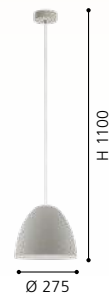

### 94354 SARABIA

pendant light; steel, grey  
Hängeleuchte; Stahl, grau  
luminaire en suspension; acier, gris

H 2000, Ø 405



E27 1x 60W



9 002759 943547



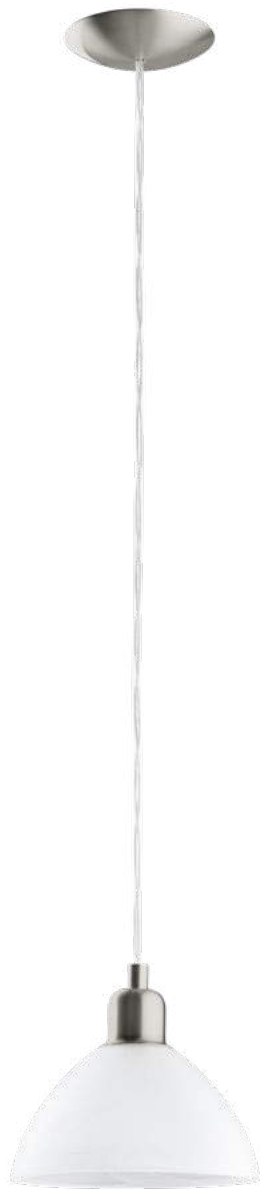

**87054**

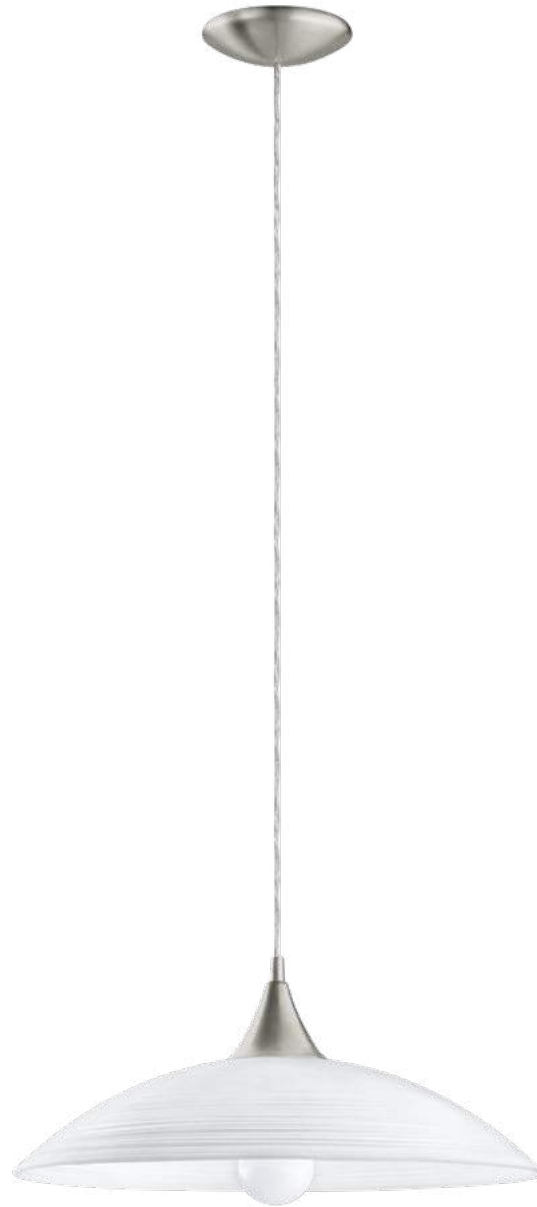

**91496**

### 87054 BRENDA

pendant light; steel, satin nickel / glass alabaster, white  
 Hängeleuchte; Stahl, nickel-matt / Glas alabaster, weiss  
 luminaire en suspension; acier, nickel mat / verre albâtre, blanc

H 1100, Ø 195



9 002759 870546



### 91496 LAZOLO

pendant light; steel, satin nickel / satin glass, white painted  
 Hängeleuchte; Stahl, nickel-matt / Glas satiniert, weiss lackiert  
 luminaire en suspension; acier, nickel mat / verre satiné, blanc laqué

H 1100, Ø 420



9 002759 914967

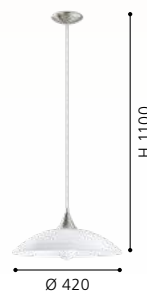

### 93468 MONTEFIO

pendant light; stainless steel, satin nickel / glass alabaster, white  
 Hängeleuchte; Edelstahl, nickel-matt / Glas alabaster, weiss  
 luminaire en suspension; acier inoxydable, nickel mat / verre albâtre, blanc

L 885, B 175, H 880 - 1300



9 002759 934682

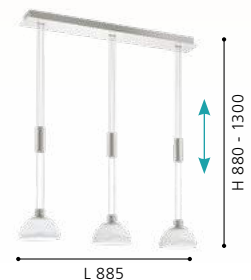



93468

LED



### 87008 LORD 2

pendant light; plastic, steel, silver, satin nickel / glass alabaster, white

Hängeleuchte; Kunststoff, Stahl, silber, nickel-matt / Glas alabaster, weiss

luminaire en suspension; plastique, acier, argent, nickel mat / verre albâtre, blanc

H 1100, Ø 360



### 87009 LORD 2

pendant light; plastic, wood, silver, satin nickel, beech / glass alabaster, white

Hängeleuchte; Kunststoff, Holz, silber, nickel-matt, Buche / Glas alabaster, weiss

luminaire en suspension; plastique, bois, argent, nickel mat, hêtre / verre albâtre, blanc

H 1100, Ø 360



### 3355, 87008, 87009



These luminaires are flexible in height thanks to the spiral cables.

Diese Leuchten sind durch die Spiralkabel in der Höhe verstellbar.

La hauteur de ces lumières peut être ajustée à l'aide du câble en spirale.

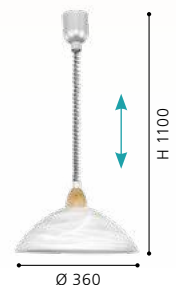





3355



90978



### 3355 ALESSANDRA

pendant light; plastic, white / glass alabaster, white  
 Hängeleuchte; Kunststoff, weiss / Glas alabaster, weiss  
 luminaire en suspension; plastique, blanc / verre albâtre, blanc

H 1100, Ø 380



9 002759 335502

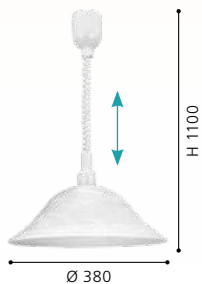

### 90978 ALBANY

pendant light; plastic, white / glass alabaster, white  
 Hängeleuchte; Kunststoff, weiss / Glas alabaster, weiss  
 luminaire en suspension; plastique, blanc / verre albâtre, blanc

H 1100, Ø 350

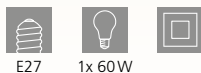

9 002759 909789

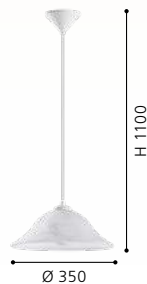

### 3355, 87008, 87009, 90978

These luminaires come with high quality processed alabaster glass.

Diese Leuchten sind mit hochwertigem Alabasterglas ausgestattet.

Ces luminaires viennent avec un abat-jour en verre d'albâtre haut de gamme.



### 3041 VETRO

pendant light; plastic, white / satin glass, white, purple, black  
 Hängeleuchte; Kunststoff, weiss / Glas satiniert, weiss, lila, schwarz  
 luminaire en suspension; plastique, blanc / verre satiné, blanc, violet, noir

H 1100, Ø 420



9 002759 304102

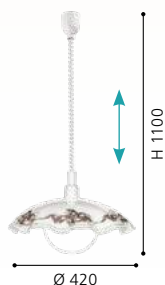

### 82786 VETRO

pendant light; plastic, white / glass, white, brown  
 Hängeleuchte; Kunststoff, weiss / Glas, weiss, braun  
 luminaire en suspension; plastique, blanc / verre, blanc, marron

H 1100, Ø 350

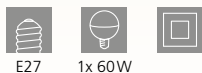

9 002759 827861

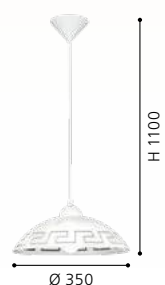

### 82785 VETRO

pendant light; plastic, white / satin glass, white  
 Hängeleuchte; Kunststoff, weiss / Glas satiniert, weiss  
 luminaire en suspension; plastique, blanc / verre satiné, blanc

H 1100, Ø 350



9 002759 827854

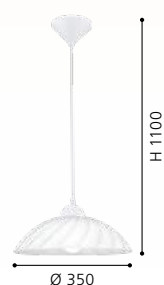



96474

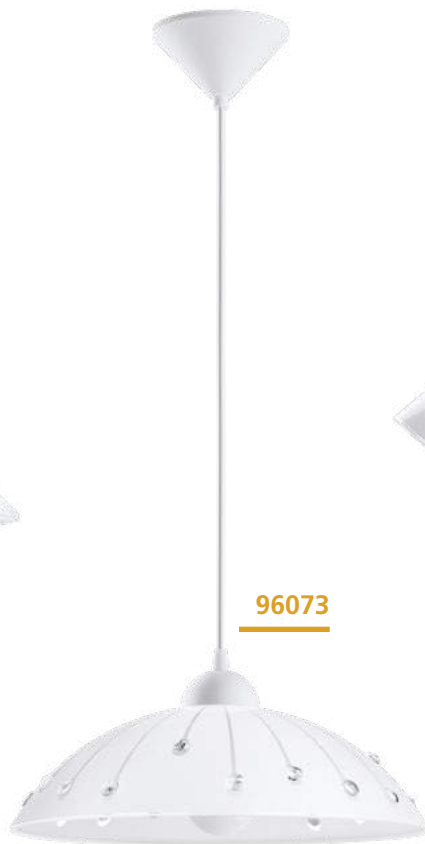

96073



96072

### 3041, 96072, 96474

These luminaires are flexible in height thanks to the spiral cables.

Diese Leuchten sind durch die Spiralkabel in der Höhe verstellbar.

La hauteur de ces lumières peut être ajustée à l'aide du câble en spirale.



### 96474 ALVEZ

pendant light; plastic, white / glass with structure, white, clear  
Hängeleuchte; Kunststoff, weiss / Glas mit Struktur, weiss, klar  
luminaire en suspension; plastique, blanc / verre avec structure, blanc, clair

H 1100, Ø 420



E27 1x 60W



9 002759 964740

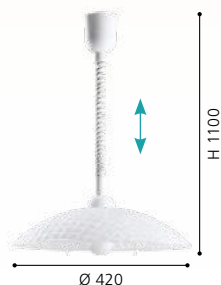

### 96073 VETRO

pendant light; plastic, white / satin glass, crystal, white, clear  
Hängeleuchte; Kunststoff, weiss / Glas satiniert, Kristall, weiss, klar  
luminaire en suspension; plastique, blanc / verre satiné, cristal, blanc, clair

H 1100, Ø 350

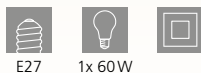

E27 1x 60W



9 002759 960735



### 96072 VETRO

pendant light; plastic, white / satin glass, crystal, white, clear  
Hängeleuchte; Kunststoff, weiss / Glas satiniert, Kristall, weiss, klar  
luminaire en suspension; plastique, blanc / verre satiné, cristal, blanc, clair

H 1100, Ø 415



E27 1x 60W



9 002759 960728



# WALL & CEILING LUMINAIRES

WAND- & DECKENLEUCHTEN  
APPLIQUES & PLAFONNIERS

## OUR ALL-ROUNDERS -

The range of wall and ceiling luminaires goes from simple to unusual designs. No matter if for the entrance area, hallway or your living rooms – these luminaires give the right light.

## UNSERE ALLROUNDER -

Das Sortiment an Wand- und Deckenleuchten reicht von schlichten bis hin zu ausgefallenen Designs. Egal ob für Eingangsbereich, Flur oder Ihre Wohnräume - diese Leuchten spenden das passende Licht.



## NOS PASSE-PARTOUT -

La gamme d'éclairages muraux et de plafonds s'étend de designs simples à extraordinaires. Que ce soit pour l'entrée, le couloir ou vos espaces d'habitat - ces luminaires apportent la lumière appropriée.



Travel makes  
you realize that  
no matter how  
much you know,  
there's always





# OVERVIEW

## WALL & CEILING LUMINAIRES

							
ALTAFLOR p. 418-420	MONIROTE p. 419, 421	IPOLITTO p. 422	ROLIMARE p. 422	GROMOLA p. 422	AMONTILLADO p. 424	SPADAFORA p. 424	MARINELLO 1 p. 424
							
MARINELLO p. 425	MIRLAS p. 426	TAMURIA p. 428	MENDIETA p. 430	PASSA RELLA p. 430	TREMEDAL p. 431	MUSARA p. 431	LABARETU p. 431
							
BOCADELLA 1 p. 432	BELSIANA p. 434	ENCINITOS p. 435	BELSIANA 1 p. 435	STAITI p. 436-437	PASSANO 1 p. 436	MONTEBALDO p. 436	SILENTINA p. 438-439
							
MOGANO p. 440	VALCASOTTO p. 442, 498	BASURTU p. 443	MAROJALES p. 445	VERSUOLA p. 445	CONDRA 1 p. 446	CABO p. 448	MASIANO 1 p. 450-451
							
FRADELO 1 p. 452-453	FRADELO p. 454-456	ACOLLA 1 p. 458	ACOLLA p. 458	CARDITO p. 459	FUERTECUSA p. 459	PITALE p. 460	VALLEMARE p. 460
							
SORRENTA 1 p. 461	NERINI p. 461	CANICOSA 2 p. 462	MONTENOVO p. 463	POZONDON p. 463	PALOMARO p. 464-466	PALOMARO 1 p. 464-466	PASTORE p. 468
							
PASTORE 1 p. 468	PASTORE 2 p. 469	GIRON p. 470	GIRON-S p. 471	FRANIA p. 472-473, 476	FRANIA-S p. 474-475, 478-479	ZAMUDILO p. 480	SILERAS p. 480-481

 This product is available in different colors and shapes./ Dieser Artikel ist in unterschiedlichen Farben und Formen verfügbar.  
Cet article est disponible en différentes couleurs et formes.

 RUIDERA p. 481	 VOLTAGO 2 p. 482-483	 LANCIANO 1 p. 484	 LANCIANO p. 484-485	 BENARIBA p. 486	 CAPASSO 1 p. 487	 COMPETA 2 p. 488	 COMPETA 1 p. 488-490
 COGOLETO p. 489	 PALERMO 2 p. 491	 CAPASSO p. 492	 NIEVES p. 492-493	 PESCAITO p. 494	 MUSURITA p. 494-495	 LAURITO p. 496	 SELUCI p. 496-497
 PENJAMO p. 499	 MENTALURGIA p. 500	 REDUCTA 2 p. 501	 LEGANES p. 501	 TORONJA p. 501	 ELLA p. 502	 DURELO p. 503	 PLANET p. 504
 LED PLANET p. 504	 PLANET 1 p. 506-509	 RICONTO 1 p. 510	 MARGITTA 1 p. 510-511	 VEREDA p. 511	 MARS p. 512-513, 518	 SCALEA 1 p. 512	 MARS 1 p. 512-514
 MAGITTA 1 p. 514	 RAYA p. 514	 GRAFIK p. 516	 NEMO p. 516	 SALOME p. 518-519	 MALVA p. 520	 MESTRE p. 520-521	 IMPERIAL p. 520
 ALMERA p. 521	 PASCAL 1 p. 521	 CAMPANIA p. 522	 GERBERA 1 p. 522	 COLTI p. 522	 TABILLANO 1 p. 524	 SAN PERI p. 524	 STAITI 1 p. 524
 GALDAKAO p. 526	 CIGLIE p. 527	 CARTIGNANO p. 528	 CIVITATE p. 529	 TAZZOLI p. 530	 GURARE p. 530	 ZINACUA p. 531	 ZUBIALDE p. 532

# OVERVIEW

## WALL & CEILING LUMINAIRES



BELATEGI  
p. 533



ONO 2  
p. 533



MACCACARI  
p. 534



MACCACARI  
p. 534



FELONICHE  
p. 535



SANIA 4  
p. 536-537



PASSA  
p. 538-541



GASCUERIA  
p. 542



ELIZONDO  
p. 542



FALICETTO  
p. 542



MONGODIO 1  
p. 544



ELGVERO  
p. 545



CADEGAL  
p. 546-547



REMIDOS  
p. 547



METRASS  
p. 548



METRASS 2  
p. 549



METRASS 1  
p. 550-551



CUPELLA  
p. 551



LASANA  
p. 552



SARGINTO  
p. 552-553



This product is available in different colors and shapes./ Dieser Artikel ist in unterschiedlichen Farben und Formen verfügbar.  
Cet article est disponible en différentes couleurs et formes.

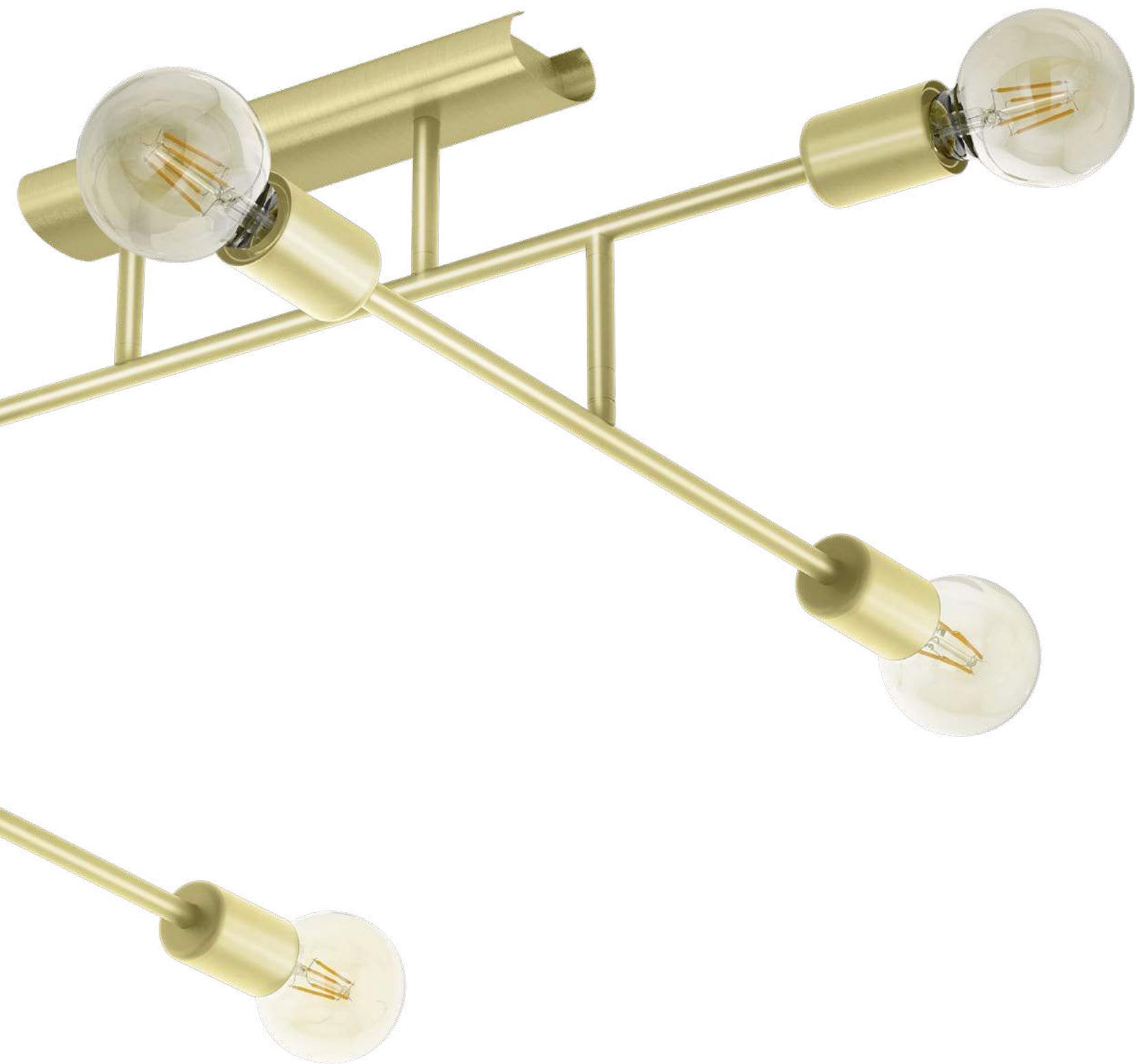

# FUNCTIONAL OVERVIEW

## FUNKTIONSÜBERSICHT

## PRÉSENTATION FONCTIONNELLE

The listed boxes inform you about the respective functions of our wall and ceiling luminaires. You will find them on the catalogue pages next to the product illustrations. The coloured symbol area indicates the special characteristics of the respective luminaire/luminaire family, e.g. dimming function. In the grey area below you will find detailed information on this function, e.g. dimmable from 10 % - 100 %.

For luminaires that come with a remote control, you can control the respective functions with the remote control. For luminaires without remote control, the functions can be switched directly on the wall switch.

Die angeführten Boxen informieren Sie über die jeweiligen Funktionen unserer Wand- und Deckenleuchten. Sie finden sie auf den Katalogseiten jeweils neben den Produktabbildungen. Der farbige Symbolbereich weist darauf hin, welche besonderen Eigenschaften die jeweilige Leuchte/Leuchtenfamilie bietet, z.B. Dimmfunktion. Im grauen Bereich darunter finden Sie detaillierte Angaben zu dieser Funktion, z.B. dimmbar von 10 % - 100 %.

Ist eine Fernbedienung im Lieferumfang enthalten, können Sie die jeweiligen Funktionen mit der Fernbedienung steuern. Bei Leuchten ohne Fernbedienung können die Funktionen direkt am Wandschalter geschaltet werden.

Les boîtes de dialogue présentes vous informent sur les fonctions respectives de nos appliques et plafonniers. Vous les trouverez sur les pages du catalogue à côté des illustrations des produits. La zone colorée des symboles indique les caractéristiques particulières de chaque luminaire/famille de luminaires, par ex. la fonction de graduation. Dans la zone grise ci-dessous, vous trouverez des informations détaillées sur cette fonction, par ex. graduable de 10 % - 100 %.

Pour les luminaires équipés d'une télécommande, vous pouvez commander les fonctions correspondantes à l'aide de la télécommande. Pour les luminaires sans télécommande, les fonctions peuvent être commutées directement sur l'interrupteur mural.



**DIMMABLE**

e.g./z.B./par ex.  
10 - 100 %

The brightness of the luminaire can be steplessly controlled.

Die Helligkeit der Leuchte kann stufenlos im angegebenen Bereich gesteuert werden.

La luminosité du luminaire peut être réglée en continu.



**STEP DIMMING**

e.g./z.B./par ex.  
10 % / 50 % / 100 %

The brightness of the luminaire can be controlled step by step.

Die Helligkeit der Leuchte kann schrittweise gesteuert werden.

La luminosité du luminaire peut être réglée pas à pas.



**TUNABLE WHITE**

e.g./z.B./par ex.  
2700 - 6500 K

The colour temperature can be controlled from warm to cold white LED light.

Die Farbtemperatur kann von warm- bis kaltweißem LED-Licht gesteuert werden.

La température de couleur peut être réglée de la lumière DEL blanche chaude à la lumière DEL blanche froide.



**STEP TUNABLE**

e.g./z.B./par ex.  
3000 / 4000 / 5000 K

The colour temperature of warm to cold white LED light can be changed directly on the wall switch in 3 preset steps.

Die Farbtemperatur von warm- bis kaltweißem LED-Licht kann direkt am Wandschalter in 3 voreingestellten Schritten verändert werden.

La température de couleur peut être modifiée de la lumière DEL blanche chaude à la lumière DEL blanche froide directement sur l'interrupteur mural en 3 étapes prédéfinies.



**NIGHT LIGHT FUNCTION**

Luminaires can be switched to a night light mode. With included remote control or, for luminaires without remote control, via wall switch (ambient light).

Leuchten können auf einen Nacht-Licht-Modus umgeschaltet werden. Mit inkludierter Fernbedienung oder bei Leuchten ohne Fernbedienung per Wandschalter (Ambient light).

Les luminaires peuvent être commutés en mode veilleuse. Avec télécommande incluse ou, pour les luminaires sans télécommande, via interrupteur mural (lumière ambiante).



**TIMER FUNCTION**

e.g./z.B./par ex.  
off after 30 sec.

The luminaire switches itself off after a preset time.

Die Leuchte schaltet sich nach einer voreingestellten Zeit selbst aus.

La lumière s'éteint d'elle-même après une durée prédéfinie.







99788

LED

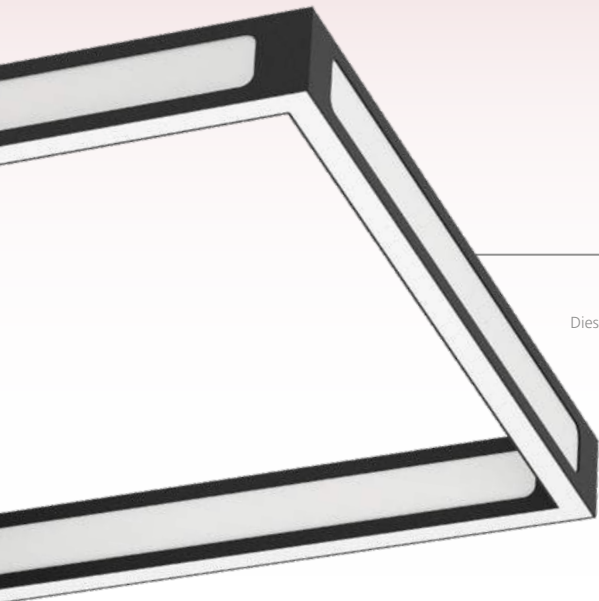

#### ALTAFLOR

These luminaires have an additional glow on the inside.

Diese Leuchten haben einen zusätzlichen Lichtschein nach Innen.

Ces luminaires ont une lueur supplémentaire à l'intérieur.

#### 99788 ALTAFLOR

ceiling light; steel, black / plastic, white  
Deckenleuchte; Stahl, schwarz / Kunststoff, weiss  
plafonnier; acier, noir / plastique, blanc

L 640, B 295, H 70

LED

24W

warm  
WHITE

2400lm



9 002759 997885

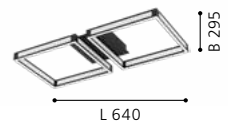

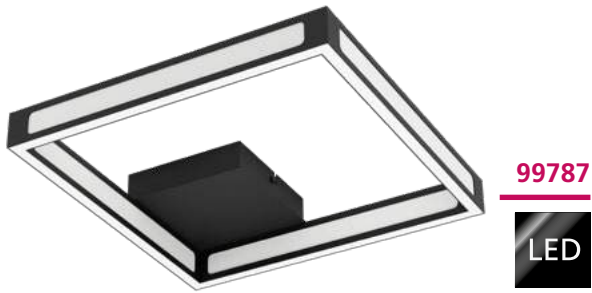

99787



99789

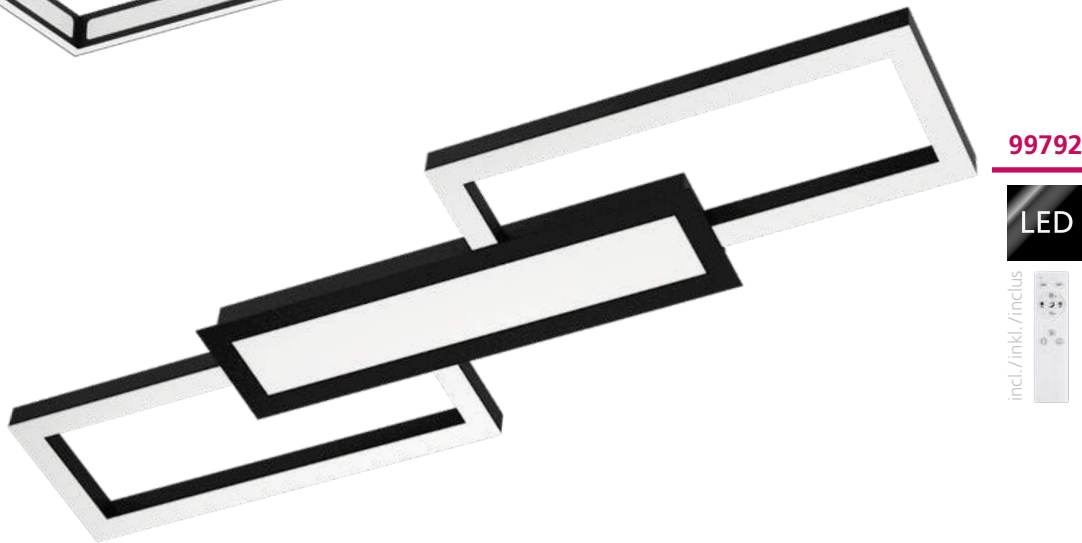

99792



### 99787 ALTAFLOR

ceiling light; steel, black / plastic, white  
Deckenleuchte; Stahl, schwarz / Kunststoff, weiss  
plafonnier; acier, noir / plastique, blanc

L 310, B 310, H 70



12W 1200lm

### 99789 ALTAFLOR

ceiling light; steel, black / plastic, white  
Deckenleuchte; Stahl, schwarz / Kunststoff, weiss  
plafonnier; acier, noir / plastique, blanc

L 990, B 295, H 70



36W 3600lm

### 99792 MONIROTE

ceiling light; steel, aluminium, black / plastic, white  
Deckenleuchte; Stahl, Alu, schwarz / Kunststoff, weiss  
plafonnier; acier, aluminium, noir / plastique, blanc

L 780, H 45



37W 4450lm remote



9 002759 997878

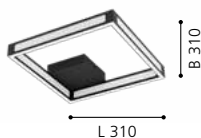

9 002759 997892

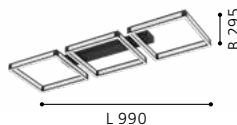

9 002759 997922

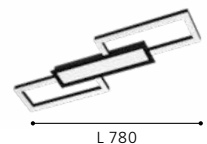



99784



99785

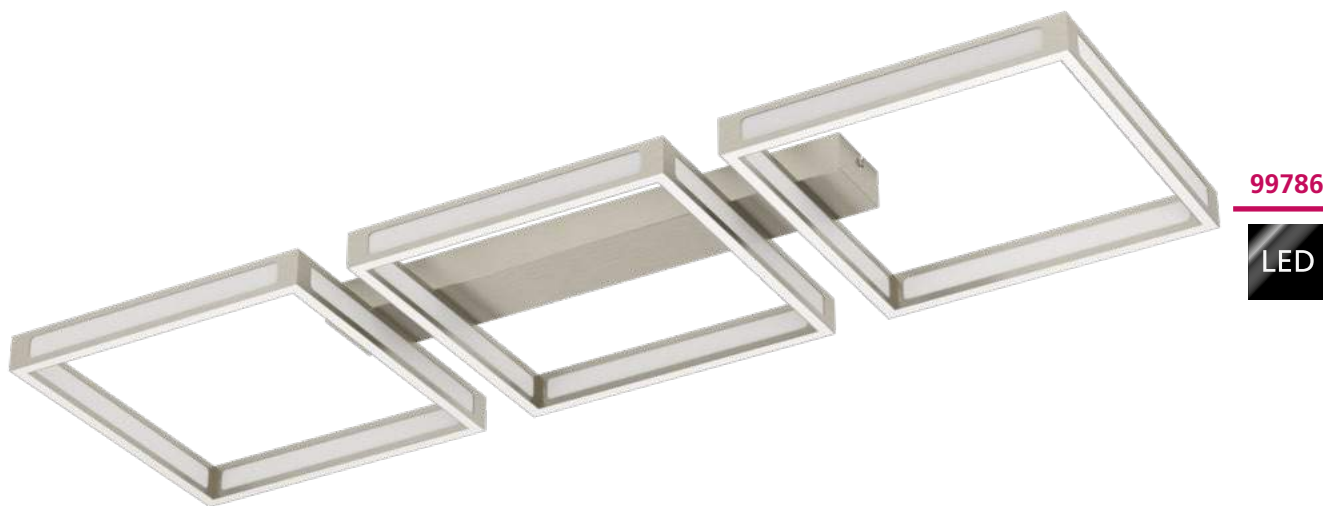

99786



### 99784 ALTAFLOR

ceiling light; steel, satin nickel / plastic, white  
 Deckenleuchte; Stahl, nickel-matt / Kunststoff, weiss  
 plafonnier; acier, nickel mat / plastique, blanc

L 310, B 310, H 70



12W 1200lm

### 99785 ALTAFLOR

ceiling light; steel, satin nickel / plastic, white  
 Deckenleuchte; Stahl, nickel-matt / Kunststoff, weiss  
 plafonnier; acier, nickel mat / plastique, blanc

L 640, B 295, H 70



24W 2400lm

### 99786 ALTAFLOR

ceiling light; steel, satin nickel / plastic, white  
 Deckenleuchte; Stahl, nickel-matt / Kunststoff, weiss  
 plafonnier; acier, nickel mat / plastique, blanc

L 990, B 295, H 70



36W 3600lm



9 002759 997847

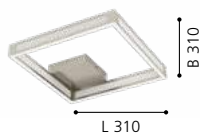

9 002759 997854

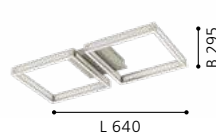

9 002759 997861

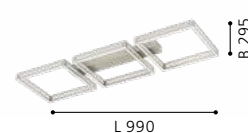





99791



incl./inkl./inclus



**99791 MONIROTE**

ceiling light; steel, aluminium, satin nickel / plastic, white  
 Deckenleuchte; Stahl, Alu, nickel-matt / Kunststoff, weiss  
 plafonnier; acier, aluminium, nickel mat / plastique, blanc

L 780, H 45



37W



4450lm



remote



9 002759 997915



L 780



99791

These luminaires have an additional glow on the inside.

Diese Leuchten haben einen zusätzlichen Lichtschein nach Innen.

Ces luminaires ont une lueur supplémentaire à l'intérieur.



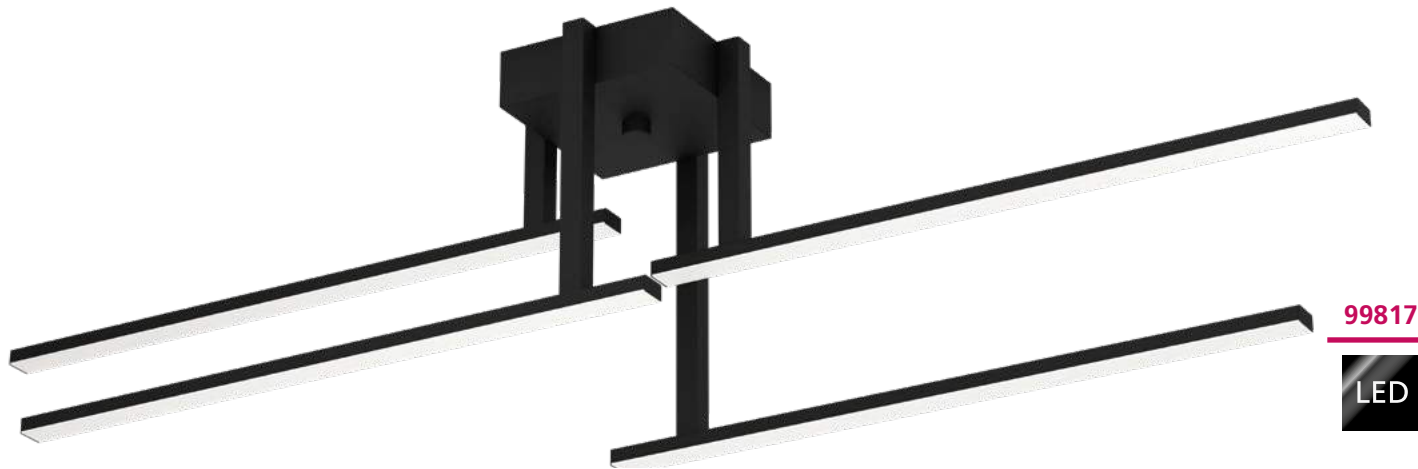

99817



99395



### 99817 IPOLITTO

ceiling light; aluminium, steel, black / plastic, white  
Deckenleuchte; Alu, Stahl, schwarz / Kunststoff, weiss  
plafonnier; aluminium, acier, noir / plastique, blanc

L 780, B 165, H 235



32W 3840lm



9 002759 998172

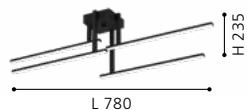

L 780

### 99395 ROLIMARE

ceiling light; aluminium, black / plastic, white  
Deckenleuchte; Alu, schwarz / Kunststoff, weiss  
plafonnier; aluminium, noir / plastique, blanc

L 420, B 400, H 130



35W 5500lm



9 002759 993955



L 420

### 98539 GROMOLA

ceiling light; aluminium, steel, black, champagne  
Deckenleuchte; Alu, Stahl, schwarz, champagner  
plafonnier; aluminium, acier, noir, champagne

H 330, Ø 540



33,8W 4000lm



9 002759 985394

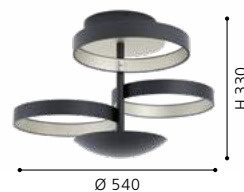

Ø 540



98539

LED



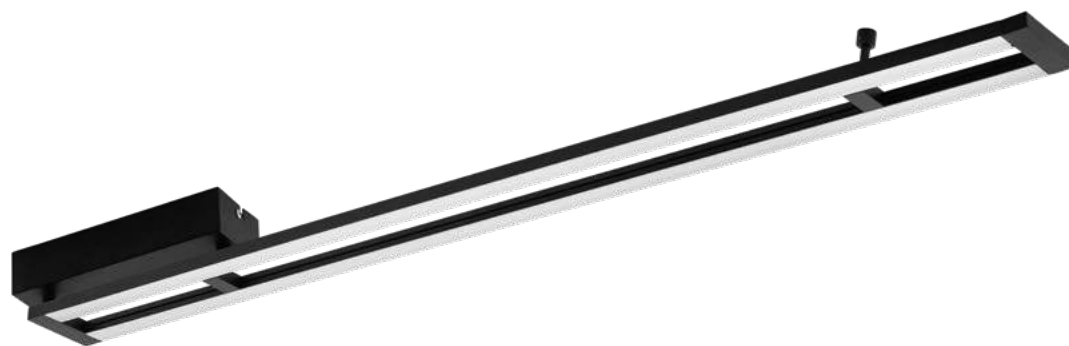

98491



98494



### 98491 AMONTILLADO

ceiling light; aluminium, steel, black / plastic, white  
 Deckenleuchte; Alu, Stahl, schwarz / Kunststoff, weiss  
 plafonnier; aluminium, acier, noir / plastique, blanc

L 1160, B 85



27W 3500lm

### 98494 SPADAFORA

ceiling light; aluminium, steel, black / plastic, clear, white  
 Deckenleuchte; Alu, Stahl, schwarz / Kunststoff, klar, weiss  
 plafonnier; aluminium, acier, noir / plastique, clair, blanc

L 1160, B 80, H 100



21W 2500lm

### 99793 MARINELLO 1

ceiling light; aluminium, steel, wood, black, brown / plastic, white  
 Deckenleuchte; Alu, Stahl, Holz, schwarz, braun / Kunststoff, weiss  
 plafonnier; aluminium, acier, bois, noir, marron / plastique, blanc

L 500, B 500, H 90



5x 5,25W 3700lm



9 002759 984915

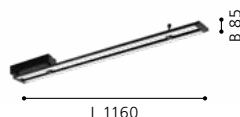

9 002759 984946



9 002759 997939

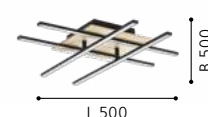



99793



99659



### 99659 MARINELLO

ceiling light; aluminium, steel, wood, black, brown / plastic, white

Deckenleuchte; Alu, Stahl, Holz, schwarz, braun / Kunststoff, weiss

plafonnier; aluminium, acier, bois, noir, marron / plastique, blanc

L 485, B 485, H 55



2x 17W



2040lm



4,2W



510lm



remote



9 002759 996598

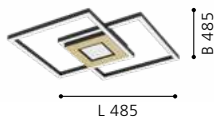



98861



98861 | 98862 | 98863



98862



### 98861 MIRLAS

ceiling light; wood, steel, brown / plastic, white  
Deckenleuchte; Holz, Stahl, braun / Kunststoff, weiss  
plafonnier; bois, acier, marron / plastique, blanc

L 360, B 210, H 90



E27



2x 9W

### 98862 MIRLAS

ceiling light; wood, steel, brown / plastic, white  
Deckenleuchte; Holz, Stahl, braun / Kunststoff, weiss  
plafonnier; bois, acier, marron / plastique, blanc

L 540, B 520, H 90



E27



4x 9W

### 98863 MIRLAS

ceiling light; wood, steel, brown / plastic, white  
Deckenleuchte; Holz, Stahl, braun / Kunststoff, weiss  
plafonnier; bois, acier, marron / plastique, blanc

L 540, B 520, H 90



E27



6x 9W



9 002759 988616

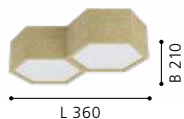

9 002759 988623

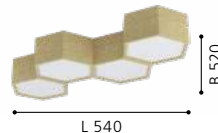

9 002759 988630

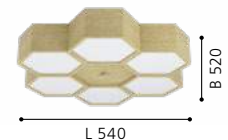





98863



99656

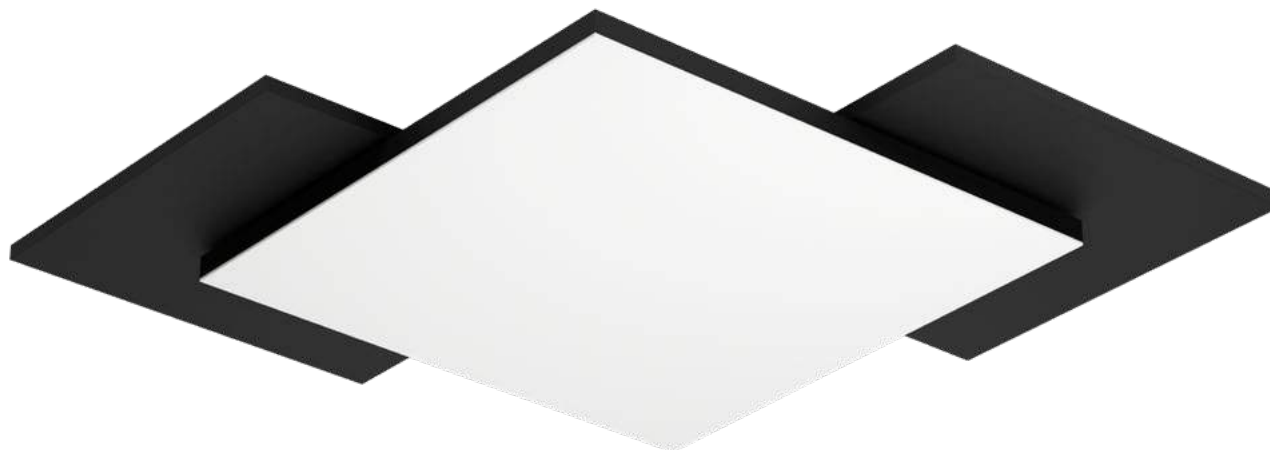

### TUMARIA

This luminaires have rotatable panels in wood look and black.

Diese Artikel verfügen über Platten in Holzoptik und schwarz zum Wechseln.

Ces luminaires a des panneaux en bois optique et noir à changer.

#### 99656 TAMURIA

ceiling light; steel, wood, black, brown / plastic, white  
Deckenleuchte; Stahl, Holz, schwarz, braun / Kunststoff, weiss  
plafonnier; acier, bois, noir, marron / plastique, blanc

L 435, B 435, H 70



24W 2800lm

#### 99655 TAMURIA

ceiling light; steel, wood, black, brown / plastic, white  
Deckenleuchte; Stahl, Holz, schwarz, braun / Kunststoff, weiss  
plafonnier; acier, bois, noir, marron / plastique, blanc

L 285, B 285, H 60



12W 1100lm



9 002759 996567



9 002759 996550





99655

LED





98675



98756



### 98675 MENDIETA

ceiling light; steel, black  
Deckenleuchte; Stahl, schwarz  
plafonnier; acier, noir

98756

The angle of the tailpipes can be installed individually.

Der Winkel der Endrohre kann individuell montiert werden.

L'angle des sorties d'échappement peut être installé individuellement.

L 1160, B 120, H 270



### 98756 PASSA RELLA

ceiling light; steel, black  
Deckenleuchte; Stahl, schwarz  
plafonnier; acier, noir

L 1605, B 110, H 120



9 002759 986759



9 002759 987565



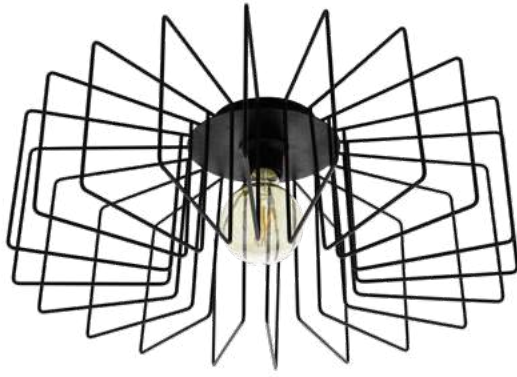

98507



98679



99014

### 98507 TREMEDAL

ceiling light; steel, black  
Deckenleuchte; Stahl, schwarz  
plafonnier; acier, noir

H 215, Ø 560



E27 1x 28W



9 002759 985073

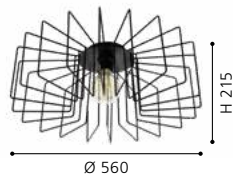

### 98679 MUSARA

ceiling light; steel, black  
Deckenleuchte; Stahl, schwarz  
plafonnier; acier, noir

H 850, Ø 790

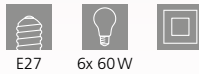

E27 6x 60W



9 002759 986797

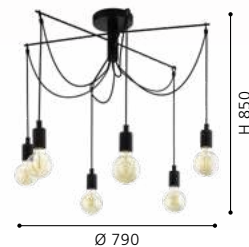

### 99014 LABARETU

ceiling light; steel, black  
Deckenleuchte; Stahl, schwarz  
plafonnier; acier, noir

L 780, B 60, H 300



E27 4x 60W



9 002759 990145







**98317**



**98318**

### 98317 BOCADELLA 1

ceiling light; steel, black  
Deckenleuchte; Stahl, schwarz  
plafonnier; acier, noir

H 215, Ø 345



E27



3x 60W



9 002759 983178

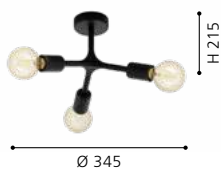

### 98318 BOCADELLA 1

ceiling light; steel, black  
Deckenleuchte; Stahl, schwarz  
plafonnier; acier, noir

H 365, Ø 640



E27



9x 60W



9 002759 983185

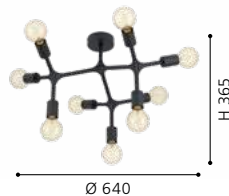

### 98319 BOCADELLA 1

ceiling light; steel, black  
Deckenleuchte; Stahl, schwarz  
plafonnier; acier, noir

H 360, Ø 920



E27



12x 60W



9 002759 983192

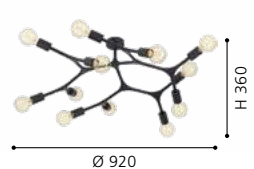



98319



**98034**



**98035**

**98034 BELSIANA**

ceiling light; steel, black  
Deckenleuchte; Stahl, schwarz  
plafonnier; acier, noir

L 890, B 510, H 350



9 002759 980344

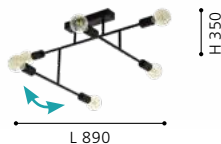

**98035 BELSIANA**

ceiling light; steel, black  
Deckenleuchte; Stahl, schwarz  
plafonnier; acier, noir

L 1180, B 510, H 350



9 002759 980351





99664

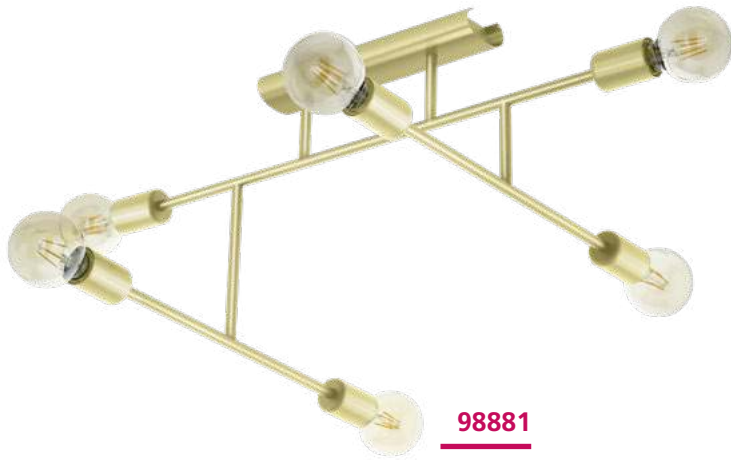

98881



98882

### 99664 ENCINITOS

ceiling light; steel, black, gold  
Deckenleuchte; Stahl, schwarz, gold  
plafonnier; acier, noir, or

H 260, Ø 450



E27 1x 40W



9 002759 996642

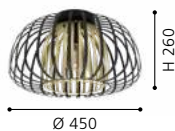

### 98881 BELSIANA 1

ceiling light; steel, brushed brass  
Deckenleuchte; Stahl, messing-gebürstet  
plafonnier; acier, laiton brossé

L 1155, B 495, H 455



E27 6x 40W



9 002759 988814

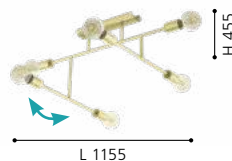

### 98882 BELSIANA 1

ceiling light; steel, brushed brass  
Deckenleuchte; Stahl, messing-gebürstet  
plafonnier; acier, laiton brossé

L 1180, B 380, H 350



E27 8x 40W



9 002759 988821

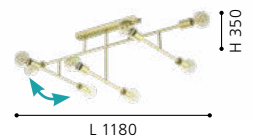

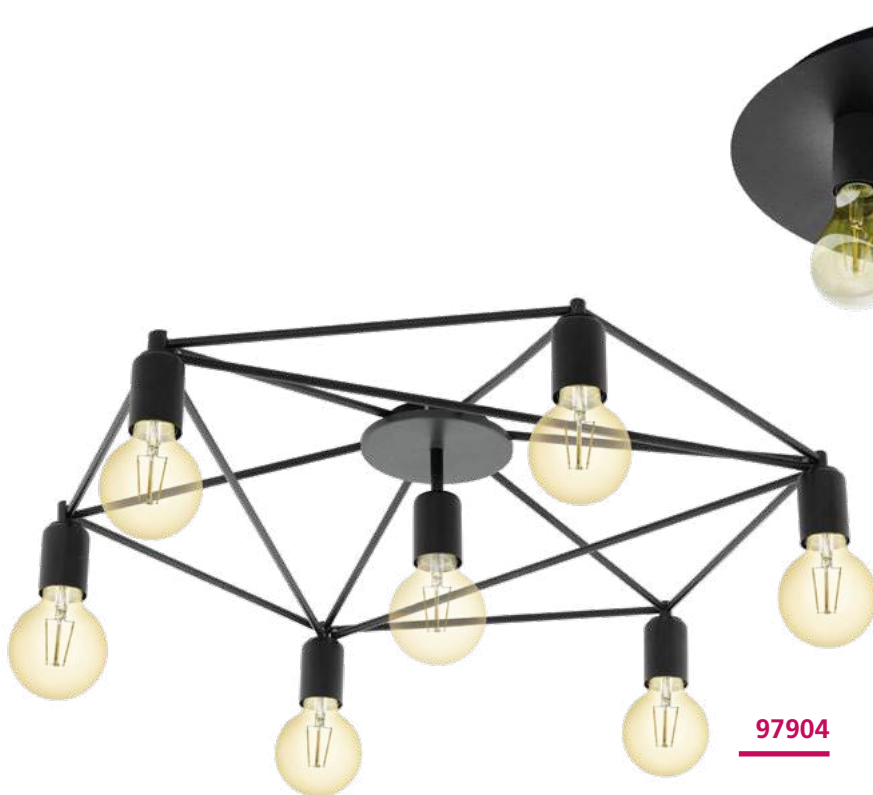

98156

97904



97731

LED

### 97904 STAITI

ceiling light; steel, black  
Deckenleuchte; Stahl, schwarz  
plafonnier; acier, noir

H 140, Ø 760



### 98156 PASSANO 1

ceiling light; steel, black  
Deckenleuchte; Stahl, schwarz  
plafonnier; acier, noir

H 95, Ø 450



### 97731 MONTEBALDO

ceiling light; steel, black, gold  
Deckenleuchte; Stahl, schwarz, gold  
plafonnier; acier, noir, or

L 380, B 380, H 170

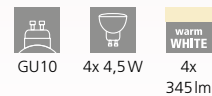

9 002759 979041



Ø 760



9 002759 981563



Ø 450



9 002759 977313



INCL.

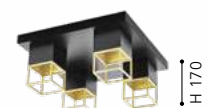

L 380





97903



97895



### 97903 STAITI

ceiling light; steel, white / fabric, white  
Deckenleuchte; Stahl, weiss / Textil, weiss  
plafonnier; acier, blanc / tissu, blanc

H 235, Ø 840



E27 7x 40W



9 002759 979034

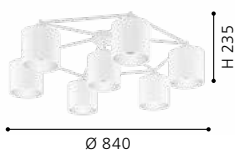

### 97895 STAITI

ceiling light; steel, black / fabric, black, gold  
Deckenleuchte; Stahl, schwarz / Textil, schwarz, gold  
plafonnier; acier, noir / tissu, noir, or

H 235, Ø 840



E27 7x 40W



9 002759 978952

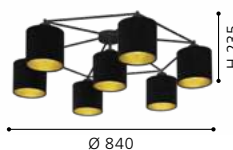



**98331**



**98332**



**98334**

**98331 SILENTINA**

ceiling light; steel, black  
Deckenleuchte; Stahl, schwarz  
plafonnier; acier, noir

L 180, B 180, H 205



E27



1x 40W

**98332 SILENTINA**

ceiling light; steel, black  
Deckenleuchte; Stahl, schwarz  
plafonnier; acier, noir

L 360, B 180, H 205



E27



2x 40W

**98334 SILENTINA**

ceiling light; steel, black  
Deckenleuchte; Stahl, schwarz  
plafonnier; acier, noir

L 360, B 360, H 205



E27



4x 40W



9 002759 983314

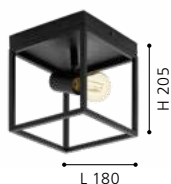

9 002759 983321

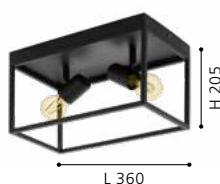

9 002759 983345





**98333**

### 98333 SILENTINA

ceiling light; steel, black  
Deckenleuchte; Stahl, schwarz  
plafonnier; acier, noir

L 540, B 180, H 205



E27



3x 40W



9 002759 983338





94547



94548

### 94547 MOGANO

ceiling light; steel, black, copper  
 Deckenleuchte; Stahl, schwarz, kupfer  
 plafonnier; acier, noir, cuivre

H 170, Ø 400



E27 1x 60W



9 002759 945473

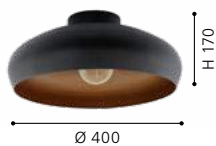

### 94548 MOGANO

ceiling light; steel, white, silver  
 Deckenleuchte; Stahl, weiss, silber  
 plafonnier; acier, blanc, argent

H 170, Ø 400



E27 1x 60W



9 002759 945480



### 43637 MOGANO

ceiling light; steel, black  
 Deckenleuchte; Stahl, schwarz  
 plafonnier; acier, noir

H 170, Ø 400

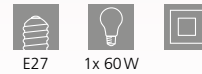

E27 1x 60W



9 002759 436377

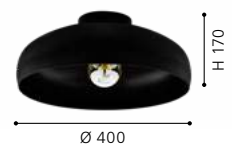



43637







99515



99514



99516



### 99514 VALCASOTTO

ceiling light; steel, black  
Deckenleuchte; Stahl, schwarz  
plafonnier; acier, noir

L 110, B 110, H 100

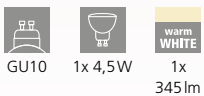

### 99515 VALCASOTTO

ceiling light; steel, black  
Deckenleuchte; Stahl, schwarz  
plafonnier; acier, noir

L 570, B 100, H 100

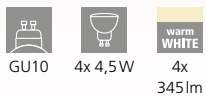

### 99516 VALCASOTTO

ceiling light; steel, black  
Deckenleuchte; Stahl, schwarz  
plafonnier; acier, noir

L 320, B 320, H 100

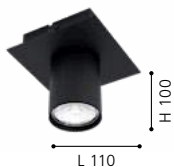
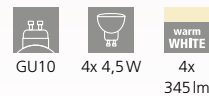



**99667**

**99667 BASURTU**

ceiling light; steel, black  
Deckenleuchte; Stahl, schwarz  
plafonnier; acier, noir

H 270, Ø 1050



E27



5x 40W



9 002759 996673

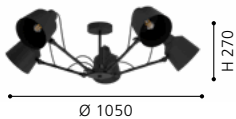



98515



**98514**



99021



98514 | 98515



**99021**

### 98515 MAROJALES

ceiling light; steel, black / glass vaporized, black-transparent  
 Deckenleuchte; Stahl, schwarz / Glas bedampft, schwarz-transparent  
 plafonnier; acier, noir / verre vaporisé, noir transparent

L 1215, B 180, H 280



E27 4x 28W



9 002759 985158



L 1215

### 98514 MAROJALES

ceiling light; steel, black / glass vaporized, black-transparent  
 Deckenleuchte; Stahl, schwarz / Glas bedampft, schwarz-transparent  
 plafonnier; acier, noir / verre vaporisé, noir transparent

L 555, B 180, H 280



E27 2x 28W



9 002759 985141



L 555

### 99021 VERSUOLA

ceiling light; steel, black / glass opal-matt, white  
 Deckenleuchte; Stahl, schwarz / Glas opal-matt, weiss  
 plafonnier; acier, noir / verre opale mat, blanc

L 770, B 200, H 325



E27 3x 40W



9 002759 990213



L 770

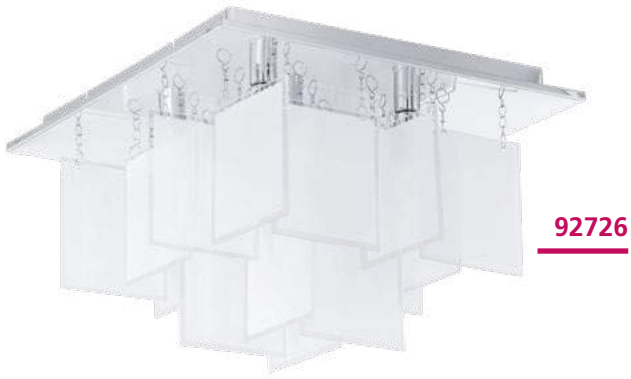

**92726**



**92813**

### 92726 CONDRA 1

ceiling light; steel, chrome / satin glass, white  
Deckenleuchte; Stahl, chrom / Glas satiniert, weiss  
plafonnier; acier, chrome / verre satiné, blanc

L 370, B 370, H 235



G9 5x 33W

### 92813 CONDRA 1

ceiling light; steel, chrome / satin glass, white, clear  
Deckenleuchte; Stahl, chrom / Glas satiniert, weiss, klar  
plafonnier; acier, chrome / verre satiné, blanc, clair

L 770, B 770, H 485



G9 16x 18W

### 92727 CONDRA 1

ceiling light; steel, chrome / satin glass, white  
Deckenleuchte; Stahl, chrom / Glas satiniert, weiss  
plafonnier; acier, chrome / verre satiné, blanc

L 470, B 470, H 300



G9 8x 18W



9 002759 927264

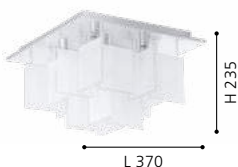

L 370



9 002759 928131

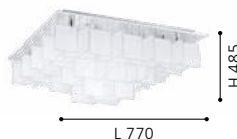

L 770



9 002759 927271



L 470





92727



30932

LED



30933

LED

### 30933 CABO

ceiling light; stainless steel, chrome / satin glass, white, clear  
Deckenleuchte; Edelstahl, chrom / Glas satiniert, weiss, klar  
plafonnier; acier inoxydable, chrome / verre satiné, blanc, clair

H 70, Ø 350

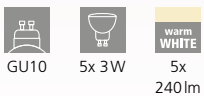

### 30932 CABO

ceiling light; stainless steel, chrome / satin glass, white, clear  
Deckenleuchte; Edelstahl, chrom / Glas satiniert, weiss, klar  
plafonnier; acier inoxydable, chrome / verre satiné, blanc, clair

L 340, B 340, H 70

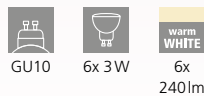

### 30931 CABO

ceiling light; stainless steel, chrome / satin glass, white, clear  
Deckenleuchte; Edelstahl, chrom / Glas satiniert, weiss, klar  
plafonnier; acier inoxydable, chrome / verre satiné, blanc, clair

L 290, B 290, H 70

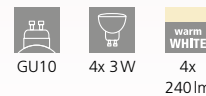



30931

LED





99361

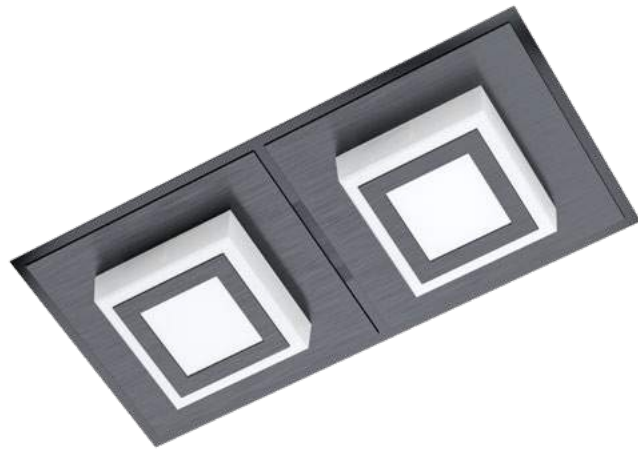

99362



99363



### 99361 MASIANO 1

wall / ceiling light; aluminium, steel, black / plastic, satiné  
Wand- / Deckenleuchte; Alu, Stahl, schwarz / Kunststoff, satiniert

applique / plafonnier; aluminium, acier, noir / plastique, satiné

L 120, B 120, H 55



1x 3,3W  
1x  
340lm

### 99362 MASIANO 1

wall / ceiling light; aluminium, steel, black / plastic, satiné  
Wand- / Deckenleuchte; Alu, Stahl, schwarz / Kunststoff, satiniert

applique / plafonnier; aluminium, acier, noir / plastique, satiné

L 250, B 120, H 50



2x 3,3W  
2x  
340lm

### 99363 MASIANO 1

wall / ceiling light; aluminium, steel, black / plastic, satiné  
Wand- / Deckenleuchte; Alu, Stahl, schwarz / Kunststoff, satiniert

applique / plafonnier; aluminium, acier, noir / plastique, satiné

L 440, B 120, H 50



3x 3,3W  
3x  
340lm



9 002759 993610

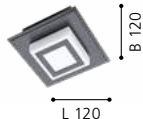

9 002759 993627

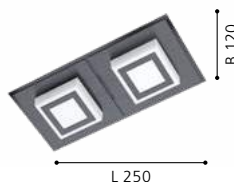

9 002759 993634

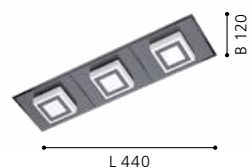



99364



### 99364 MASIANO 1

wall / ceiling light; aluminium, steel, black / plastic, satined

Wand- / Deckenleuchte; Alu, Stahl, schwarz / Kunststoff, satiniert

applique / plafonnier; aluminium, acier, noir / plastique, satiné

L 250, B 250, H 55

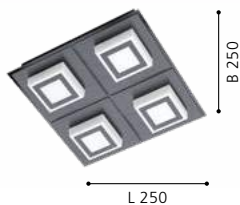





99324

LED



99325

LED



99328

LED

### 99324 FRADELO 1

wall / ceiling light; steel, black / plastic, crystal, black, clear  
Wand- / Deckenleuchte; Stahl, schwarz / Kunststoff, Kristall, schwarz, klar  
applique / plafonnier; acier, noir / plastique, cristal, noir, clair

L 140, B 140, H 60



1x 4W  
1x  
400lm

### 99325 FRADELO 1

wall / ceiling light; steel, black / plastic, crystal, black, clear  
Wand- / Deckenleuchte; Stahl, schwarz / Kunststoff, Kristall, schwarz, klar  
applique / plafonnier; acier, noir / plastique, cristal, noir, clair

L 460, B 140, H 60



3x 4W  
3x  
400lm

### 99328 FRADELO 1

ceiling light; steel, black / plastic, crystal, black, clear  
Deckenleuchte; Stahl, schwarz / Kunststoff, Kristall, schwarz, klar  
plafonnier; acier, noir / plastique, cristal, noir, clair

L 520, B 520, H 95



12W  
1250lm



9 002759 993245

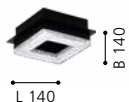

9 002759 993252

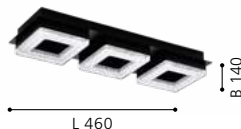

9 002759 993283

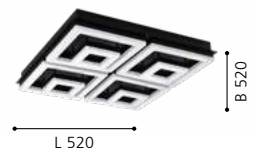



99327

LED

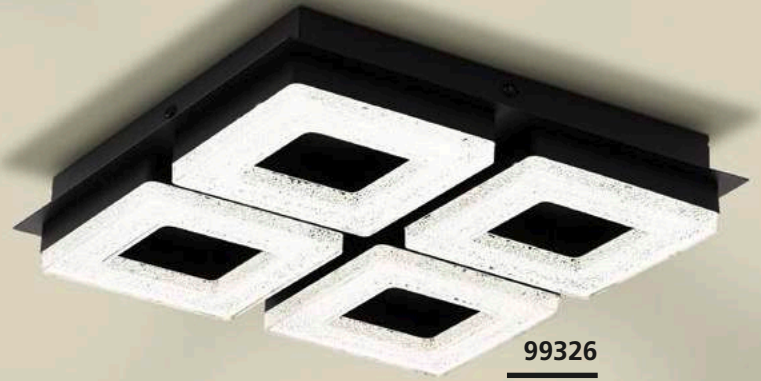

99326

LED



### 99327 FRADELO 1

ceiling light; steel, black / plastic, crystal, black, clear  
 Deckenleuchte; Stahl, schwarz / Kunststoff, Kristall, schwarz, klar  
 plafonnier; acier, noir / plastique, cristal, noir, clair

L 260, B 260, H 85



12W 1250lm

### 99326 FRADELO 1

wall / ceiling light; steel, black / plastic, crystal, black, clear  
 Wand- / Deckenleuchte; Stahl, schwarz / Kunststoff, Kristall, schwarz, klar  
 applique / plafonnier; acier, noir / plastique, cristal, noir, clair

L 280, B 280, H 60



4x 4W 4x 400lm



9 002759 993276

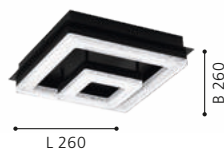

9 002759 993269

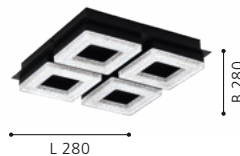

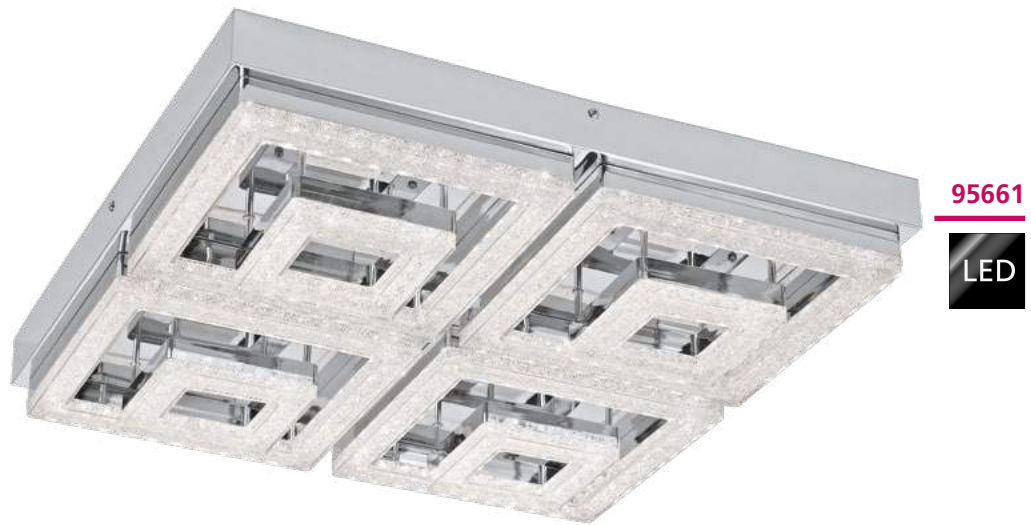
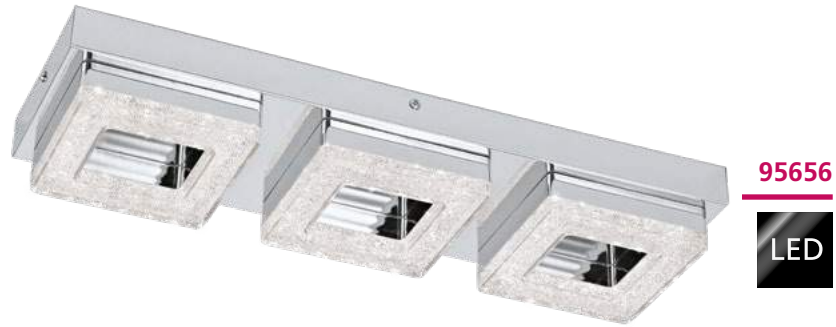

### 95655 FRADELO

wall / ceiling light; steel, chrome / plastic, crystal, chrome, clear  
 Wand- / Deckenleuchte; Stahl, chrom / Kunststoff, Kristall, chrom, klar  
 applique / plafonnier; acier, chrome / plastique, cristal, chrome, clair

L 140, B 140, H 60



1x 4W 400lm

### 95656 FRADELO

wall / ceiling light; steel, chrome / plastic, crystal, chrome, clear  
 Wand- / Deckenleuchte; Stahl, chrom / Kunststoff, Kristall, chrom, klar  
 applique / plafonnier; acier, chrome / plastique, cristal, chrome, clair

L 460, B 140, H 60



3x 4W 1200lm

### 95661 FRADELO

ceiling light; steel, chrome / plastic, crystal, chrome, clear  
 Deckenleuchte; Stahl, chrom / Kunststoff, Kristall, chrom, klar  
 plafonnier; acier, chrome / plastique, cristal, chrome, clair

L 520, B 520, H 95



48W 5000lm



9 002759 956554



9 002759 956561



9 002759 956615



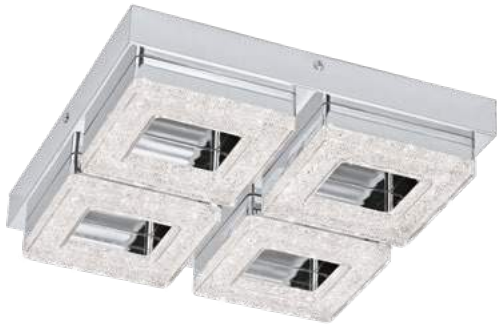

95657

LED



95659

LED



95658

LED



### 95657 FRADELO

wall / ceiling light; steel, chrome / plastic, crystal, chrome, clear  
Wand- / Deckenleuchte; Stahl, chrom / Kunststoff, Kristall, chrom, klar  
applique / plafonnier; acier, chrome / plastique, cristal, chrome, clair

L 280, B 280, H 60



4x 4W 1600lm

### 95659 FRADELO

ceiling light; steel, chrome / plastic, crystal, chrome, clear  
Deckenleuchte; Stahl, chrom / Kunststoff, Kristall, chrom, klar  
plafonnier; acier, chrome / plastique, cristal, chrome, clair

L 260, B 260, H 85



12W 1250lm

### 95658 FRADELO

wall / ceiling light; steel, chrome / plastic, crystal, chrome, clear  
Wand- / Deckenleuchte; Stahl, chrom / Kunststoff, Kristall, chrom, klar  
applique / plafonnier; acier, chrome / plastique, cristal, chrome, clair

L 440, B 440, H 70



9x 4W 3600lm



9 002759 956578



9 002759 956592

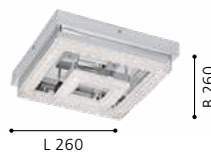

9 002759 956585







95662



95663



### 95662 FRADELO

wall / ceiling light; steel, chrome / plastic, crystal, chrome, clear  
Wand- / Deckenleuchte; Stahl, chrom / Kunststoff, Kristall, chrom, klar  
applique / plafonnier; acier, chrome / plastique, cristal, chrome, clair

L 140, B 140, H 60



1x 4W



400lm



### 95663 FRADELO

wall / ceiling light; steel, chrome / plastic, crystal, chrome, clear  
Wand- / Deckenleuchte; Stahl, chrom / Kunststoff, Kristall, chrom, klar  
applique / plafonnier; acier, chrome / plastique, cristal, chrome, clair

L 460, B 140, H 60



3x 4W



1200lm



### 95664 FRADELO

wall / ceiling light; steel, chrome / plastic, crystal, chrome, clear  
Wand- / Deckenleuchte; Stahl, chrom / Kunststoff, Kristall, chrom, klar  
applique / plafonnier; acier, chrome / plastique, cristal, chrome, clair

L 280, B 280, H 60



4x 4W



1600lm



9 002759 956622



9 002759 956639



9 002759 956646







95664

LED





99357

LED



99356

LED



95639

LED

### 99357 ACOLLA 1

wall / ceiling light; steel, black / glass with crystals, white, clear  
Wand- / Deckenleuchte; Stahl, schwarz / Glas mit Kristallen, weiss, klar  
applique / plafonnier; acier, noir / verre avec cristaux, blanc, clair

H 90, Ø 370



16W 1500lm

### 99356 ACOLLA 1

wall / ceiling light; steel, black / glass with crystals, white, clear  
Wand- / Deckenleuchte; Stahl, schwarz / Glas mit Kristallen, weiss, klar  
applique / plafonnier; acier, noir / verre avec cristaux, blanc, clair

H 85, Ø 290



11W 950lm

### 95639 ACOLLA

wall / ceiling light; steel, chrome / glass with crystals, white, clear  
Wand- / Deckenleuchte; Stahl, chrom / Glas mit Kristallen, weiss, klar  
applique / plafonnier; acier, chrome / verre avec cristaux, blanc, clair

H 85, Ø 290



11W 950lm



9 002759 993573



Ø 370



9 002759 993566



Ø 290



9 002759 956394



Ø 290



32025

LED



32026

LED



98597

LED

### 32025 CARDITO

ceiling light; steel, chrome / glass, crystal, clear  
Deckenleuchte; Stahl, chrom / Glas, Kristall, klar  
plafonnier; acier, chrome / verre, cristal, clair

L 320, B 320, H 55



16W 1700lm

### 32026 CARDITO

ceiling light; steel, chrome / glass, crystal, clear  
Deckenleuchte; Stahl, chrom / Glas, Kristall, klar  
plafonnier; acier, chrome / verre, cristal, clair

L 440, B 440, H 55



4x 6,7W 3400lm

### 98597 FUERTESCUSA

wall light; steel, chrome / crystal, clear  
Wandleuchte; Stahl, chrom / Kristall, klar  
applique; acier, chrome / cristal, clair

L 130, H 130, A 110

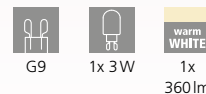

G9 1x 3W 1x 360lm



9 002759 320256



9 002759 320263



9 002759 985974

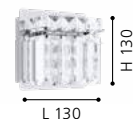



95162

LED



### 95162 PITALE

ceiling light; steel, chrome / satin glass, white  
Deckenleuchte; Stahl, chrom / Glas satiniert, weiss  
plafonnier; acier, chrome / verre satiné, blanc

H 100, Ø 630



G9



6x 3W



6x  
360lm

### PITALE, VALLEMARE

These luminaires come with high quality glass crystals.

Diese Leuchten sind mit hochwertigen Glaskristallen ausgestattet.

Ces luminaires viennent avec des cristaux de verre de haute qualité.



9 002759 951627



INCL.



Ø 630

### 97487 VALLEMARE

wall / ceiling light; aluminium, steel, chrome / plastic, crystal, white, clear

Wand- / Deckenleuchte; Alu, Stahl, chrom / Kunststoff, Kristall, weiss, klar

applique / plafonnier; aluminium, acier, chrome / plastique, cristal, blanc, clair

H 125, Ø 650



5x 6,6W



5x  
800lm



9 002759 974879



Ø 650





95689



95576



97487



### 95689 SORRENTA 1

wall / ceiling light; steel, white / glass with crystals, white, clear  
Wand- / Deckenleuchte; Stahl, weiss / Glas mit Kristallen, weiss, klar  
applique / plafonnier; acier, blanc / verre avec cristaux, blanc, clair

H 95, Ø 315



16W 1500lm

### 95576 NERINI

wall / ceiling light; steel, white / glass with crystals, white, black, clear  
Wand- / Deckenleuchte; Stahl, weiss / Glas mit Kristallen, weiss, schwarz, klar  
applique / plafonnier; acier, blanc / verre avec cristaux, blanc, noir, clair

H 90, Ø 315



16W 1500lm



9 002759 956899



Ø 315



9 002759 955762



Ø 315

### SORRENTA 1, NERINI

These luminaires come with high quality glass crystals.

Diese Leuchten sind mit hochwertigen Glaskristallen ausgestattet.

Ces luminaires viennent avec des cristaux de verre de haute qualité.





98527

LED

incl./inkl./inclus



TUNABLE WHITE	STEP DIMMING	NIGHT LIGHT FUNCTION	<b>98527</b>
<ol style="list-style-type: none"> <li>warmwhite (2700K/100%)</li> <li>neutralwhite 3850K (2700K/50% + 5000K/50%)</li> <li>coldwhite (5000K/100%)</li> </ol>			<b>98685</b>



98685

LED

incl./inkl./inclus



### 98527 CANICOSA 2

wall / ceiling light; plastic, steel, black, gold / plastic with granille, transparent

Wand- / Deckenleuchte; Kunststoff, Stahl, schwarz, gold / Kunststoff mit Granille, transparent

applique / plafonnier; plastique, acier, noir, or / plastique avec granille, transparent

H 90, Ø 495



24,5W



3000lm



remote



### 98685 CANICOSA 2

wall / ceiling light; plastic, steel, black, gold / plastic with granille, transparent

Wand- / Deckenleuchte; Kunststoff, Stahl, schwarz, gold / Kunststoff mit Granille, transparent

applique / plafonnier; plastique, acier, noir, or / plastique avec granille, transparent

H 145, Ø 765



37W



4600lm



remote



9 002759 985271



9 002759 986858





98023



98487



98488



### 98023 MONTENOVO

wall / ceiling light; steel, white / glass, white, gold  
Wand- / Deckenleuchte; Stahl, weiss / Glas, weiss, gold  
applique / plafonnier; acier, blanc / verre, blanc, or

H 100, Ø 395



16W 1500lm



9 002759 980238



### 98487 POZONDON

ceiling light; steel, gold-coloured / plastic, white  
Deckenleuchte; Stahl, goldfarben / Kunststoff, weiss  
plafonnier; acier, doré / plastique, blanc

H 100, Ø 380



18W 2000lm



9 002759 984878

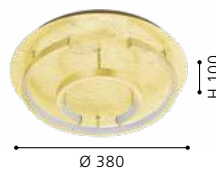

### 98488 POZONDON

ceiling light; steel, gold-coloured / plastic, white  
Deckenleuchte; Stahl, goldfarben / Kunststoff, weiss  
plafonnier; acier, doré / plastique, blanc

H 120, Ø 520



24W 2850lm



9 002759 984885

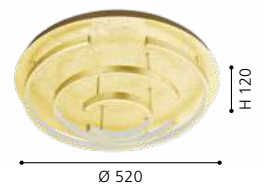

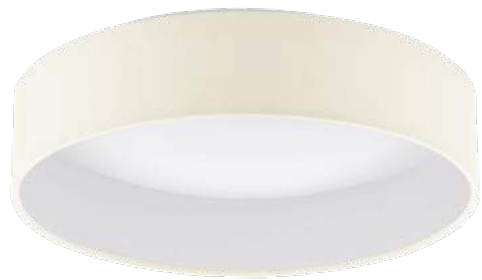

93392

LED



96537

LED



93394

LED

### PALOMARO, PALOMARO 1

Convenient light effect due to the indirect illumination

Angenehmer Lichteffect durch indirekte Beleuchtung

Effet de lumière pratique en raison de l'éclairage indirect

#### 93392 PALOMARO

ceiling light; plastic, white / fabric, creme  
Deckenleuchte; Kunststoff, weiss / Textil, creme  
plafonnier; plastique, blanc / tissu, crème

H 90, Ø 320

LED

11W

warm  
WHITE

950lm



#### 96537 PALOMARO 1

ceiling light; plastic, white / fabric, creme  
Deckenleuchte; Kunststoff, weiss / Textil, creme  
plafonnier; plastique, blanc / tissu, crème

H 100, Ø 405

LED

18W

warm  
WHITE

2000lm



#### 93394 PALOMARO

ceiling light; plastic, white / fabric, creme  
Deckenleuchte; Kunststoff, weiss / Textil, creme  
plafonnier; plastique, blanc / tissu, crème

H 110, Ø 500

LED

24W

warm  
WHITE

2100lm



9 002759 933920



9 002759 965372



9 002759 933944

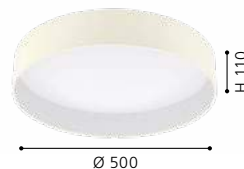



96539



93949



93952



### 93949 PALOMARO

ceiling light; plastic, white / fabric, taupe  
Deckenleuchte; Kunststoff, weiss / Textil, taupe  
plafonnier; plastique, blanc / tissu, taupe

H 90, Ø 320



11W 950lm

### 96539 PALOMARO 1

ceiling light; plastic, white / fabric, taupe  
Deckenleuchte; Kunststoff, weiss / Textil, taupe  
plafonnier; plastique, blanc / tissu, taupe

H 100, Ø 405



18W 2000lm

### 93952 PALOMARO

ceiling light; plastic, white / fabric, taupe  
Deckenleuchte; Kunststoff, weiss / Textil, taupe  
plafonnier; plastique, blanc / tissu, taupe

H 110, Ø 500



24W 2100lm



9 002759 939496



9 002759 965396



9 002759 939526





96538



93395



93397



### 93395 PALOMARO

ceiling light; plastic, white / fabric, anthracite  
Deckenleuchte; Kunststoff, weiss / Textil, anthrazit  
plafonnier; plastique, blanc / tissu, anthracite

H 90, Ø 320



11W 950lm

### 96538 PALOMARO 1

ceiling light; plastic, white / fabric, anthracite  
Deckenleuchte; Kunststoff, weiss / Textil, anthrazit  
plafonnier; plastique, blanc / tissu, anthracite

H 100, Ø 405



18W 2000lm

### 93397 PALOMARO

ceiling light; plastic, white / fabric, anthracite  
Deckenleuchte; Kunststoff, weiss / Textil, anthrazit  
plafonnier; plastique, blanc / tissu, anthracite

H 110, Ø 500



24W 2100lm



9 002759 933951



9 002759 965389



9 002759 933975







## PALOMARO, PALOMARO 1

Convenient light effect due to the indirect illumination

Angenehmer Lichteffekt durch indirekte Beleuchtung

Effet de lumière pratique en raison de l'éclairage indirect



**97479**



**97838**



**98409**

### 97479 PASTORE

ceiling light; steel, white / fabric, anthracite-brown, white, grey  
Deckenleuchte; Stahl, weiss / Textil, anthrazit-braun, weiss, grau  
plafonnier; acier, blanc / tissu, anthracite marron, blanc, gris

L 610, B 495, H 255



E27



3x 60W

### 97838 PASTORE

ceiling light; steel, white / fabric, brown, grey, white, black  
Deckenleuchte; Stahl, weiss / Textil, braun, grau, weiss, schwarz  
plafonnier; acier, blanc / tissu, marron, gris, blanc, noir

H 285, Ø 990



E27



6x 40W

### 98409 PASTORE 1

ceiling light; steel, white / fabric, taupe  
Deckenleuchte; Stahl, weiss / Textil, taupe  
plafonnier; acier, blanc / tissu, taupe

H 250, Ø 990



E27



6x 40W



9 002759 974794

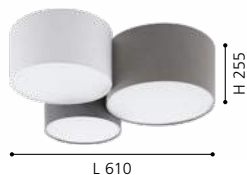

L 610



9 002759 978389



Ø 990



9 002759 984090



Ø 990



**99508**



97479 | 97838 | 98409  
99508 | 99509



**99509**



### 99508 PASTORE 2

ceiling light; steel, white / fabric, black, white  
Deckenleuchte; Stahl, weiss / Textil, schwarz, weiss  
plafonnier; acier, blanc / tissu, noir, blanc

L 610, B 495, H 255



E27 3x 60W



9 002759 995089



### 99509 PASTORE 2

ceiling light; steel, white / fabric, black, white  
Deckenleuchte; Stahl, weiss / Textil, schwarz, weiss  
plafonnier; acier, blanc / tissu, noir, blanc

H 285, Ø 990



E27 6x 40W



9 002759 995096





97526



incl./inkl./inclus



97527



incl./inkl./inclus



97528



incl./inkl./inclus



 <b>TUNABLE WHITE</b> 3000 - 5000 K	 <b>DIMMABLE</b> 10 - 100 %	 <b>TIMER FUNCTION</b> off after 30sec.	 <b>NIGHT LIGHT FUNCTION</b>	<b>97526</b>	<b>97541</b>
				<b>97527</b>	<b>97542</b>
				<b>97528</b>	<b>97543</b>

### 97526 GIRON

ceiling light; steel, white / plastic, white  
Deckenleuchte; Stahl, weiss / Kunststoff, weiss  
plafonnier; acier, blanc / plastique, blanc

H 75, Ø 570



40W



4000lm



remote

### 97527 GIRON

ceiling light; steel, white / plastic, white  
Deckenleuchte; Stahl, weiss / Kunststoff, weiss  
plafonnier; acier, blanc / plastique, blanc

H 85, Ø 760



60W



5800lm



remote

### 97528 GIRON

ceiling light; steel, white / plastic, white  
Deckenleuchte; Stahl, weiss / Kunststoff, weiss  
plafonnier; acier, blanc / plastique, blanc

H 120, Ø 1000



80W



7800lm



remote



9 002759 975265



Ø 570



9 002759 975272



Ø 760



9 002759 975289



Ø 1000





97541



incl./inkl./inclus



97542



incl./inkl./inclus



97543



incl./inkl./inclus

### 97541 GIRON-S

ceiling light; steel, white / plastic with crystal effect, white  
Deckenleuchte; Stahl, weiss / Kunststoff m.Kristalleffekt, weiss  
plafonnier; acier, blanc / plastique avec effet cristal, blanc

H 75, Ø 570



40W

4000lm

remote

### 97542 GIRON-S

ceiling light; steel, white / plastic with crystal effect, white  
Deckenleuchte; Stahl, weiss / Kunststoff m.Kristalleffekt, weiss  
plafonnier; acier, blanc / plastique avec effet cristal, blanc

H 85, Ø 760



60W

5800lm

remote

### 97543 GIRON-S

ceiling light; steel, white / plastic with crystal effect, white  
Deckenleuchte; Stahl, weiss / Kunststoff m.Kristalleffekt, weiss  
plafonnier; acier, blanc / plastique avec effet cristal, blanc

H 120, Ø 1000



80W

7800lm

remote



9 002759 975418



Ø 570



9 002759 975425



Ø 760



9 002759 975432



Ø 1000





97871



97872



97873



### 97871 FRANIA

wall / ceiling light; steel, white / plastic, white  
Wand- / Deckenleuchte; Stahl, weiss / Kunststoff, weiss  
applique / plafonnier; acier, blanc / plastique, blanc

H 70, Ø 280



11,5W 1350lm

### 97872 FRANIA

wall / ceiling light; steel, white / plastic, white  
Wand- / Deckenleuchte; Stahl, weiss / Kunststoff, weiss  
applique / plafonnier; acier, blanc / plastique, blanc

H 70, Ø 330



17,3W 2000lm

### 97873 FRANIA

wall / ceiling light; steel, white / plastic, white  
Wand- / Deckenleuchte; Stahl, weiss / Kunststoff, weiss  
applique / plafonnier; acier, blanc / plastique, blanc

H 70, Ø 430



33,5W 3900lm



9 002759 978716



Ø 280



9 002759 978723



Ø 330



9 002759 978730



Ø 430



98446



### 98446 FRANIA

wall / ceiling light; steel, white / plastic, white  
Wand- / Deckenleuchte; Stahl, weiss / Kunststoff, weiss  
applique / plafonnier; acier, blanc / plastique, blanc

H 70, Ø 550

LED    warm WHITE   

49,5W    5700lm





97877



97878



97879



### 97877 FRANIA-S

wall / ceiling light; steel, white / plastic with crystal effect, white  
Wand- / Deckenleuchte; Stahl, weiss / Kunststoff m.Kristalleffekt, weiss  
applique / plafonnier; acier, blanc / plastique avec effet cristal, blanc

H 70, Ø 280



11,5W 1350lm

### 97878 FRANIA-S

wall / ceiling light; steel, white / plastic with crystal effect, white  
Wand- / Deckenleuchte; Stahl, weiss / Kunststoff m.Kristalleffekt, weiss  
applique / plafonnier; acier, blanc / plastique avec effet cristal, blanc

H 70, Ø 330



17,3W 2000lm

### 97879 FRANIA-S

wall / ceiling light; steel, white / plastic with crystal effect, white  
Wand- / Deckenleuchte; Stahl, weiss / Kunststoff m.Kristalleffekt, weiss  
applique / plafonnier; acier, blanc / plastique avec effet cristal, blanc

H 70, Ø 430



33,5W 3900lm



9 002759 978778



Ø 280



9 002759 978785



Ø 330



9 002759 978792



Ø 430



98448

LED

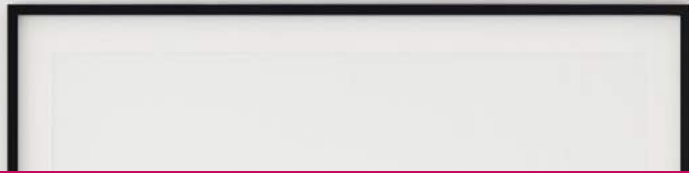

### 98448 FRANIA-S

wall / ceiling light; steel, white / plastic with crystal effect, white

Wand- / Deckenleuchte; Stahl, weiss / Kunststoff m. Kristalleffekt, weiss

applique / plafonnier; acier, blanc / plastique avec effet cristal, blanc

H 70, Ø 550

LED

warm  
WHITE



49,5W 5700lm





97874



97875



97876



### 97874 FRANIA

wall / ceiling light; steel, white / plastic, white  
Wand- / Deckenleuchte; Stahl, weiss / Kunststoff, weiss  
applique / plafonnier; acier, blanc / plastique, blanc

L 280, B 280, H 70



11,5W 1350lm

### 97875 FRANIA

wall / ceiling light; steel, white / plastic, white  
Wand- / Deckenleuchte; Stahl, weiss / Kunststoff, weiss  
applique / plafonnier; acier, blanc / plastique, blanc

L 330, B 330, H 70



17,3W 2000lm

### 97876 FRANIA

wall / ceiling light; steel, white / plastic, white  
Wand- / Deckenleuchte; Stahl, weiss / Kunststoff, weiss  
applique / plafonnier; acier, blanc / plastique, blanc

L 430, B 430, H 70



33,5W 3900lm



9 002759 978747

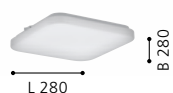

9 002759 978754



9 002759 978761







98447



### 98447 FRANIA

wall / ceiling light; steel, white / plastic, white  
Wand- / Deckenleuchte; Stahl, weiss / Kunststoff, weiss  
applique / plafonnier; acier, blanc / plastique, blanc

L 530, B 530, H 70



49,5W



5700lm



9 002759 984472





97881



97882



97883



### 97881 FRANIA-S

wall / ceiling light; steel, white / plastic with crystal effect, white  
Wand- / Deckenleuchte; Stahl, weiss / Kunststoff m.Kristalleffekt, weiss  
applique / plafonnier; acier, blanc / plastique avec effet cristal, blanc

L 280, B 280, H 70



11,5W 1350lm

### 97882 FRANIA-S

wall / ceiling light; steel, white / plastic with crystal effect, white  
Wand- / Deckenleuchte; Stahl, weiss / Kunststoff m.Kristalleffekt, weiss  
applique / plafonnier; acier, blanc / plastique avec effet cristal, blanc

L 330, B 330, H 70



17,3W 2000lm

### 97883 FRANIA-S

wall / ceiling light; steel, white / plastic with crystal effect, white  
Wand- / Deckenleuchte; Stahl, weiss / Kunststoff m.Kristalleffekt, weiss  
applique / plafonnier; acier, blanc / plastique avec effet cristal, blanc

L 430, B 430, H 70



33,5W 3900lm



9 002759 978815



9 002759 978822



9 002759 978839





98449

LED

### 98449 FRANIA-S

wall / ceiling light; steel, white / plastic with crystal effect, white

Wand- / Deckenleuchte; Stahl, weiss / Kunststoff m. Kristalleffekt, weiss

applique / plafonnier; acier, blanc / plastique avec effet cristal, blanc

L 530, B 530, H 70

LED

49,5W

warm  
WHITE

5700lm





99341



incl./inkl./inclus



99342



incl./inkl./inclus



97577



incl./inkl./inclus

**TUNABLE WHITE**  
2700 - 6500 K

**STEP DIMMING**  
10/25/50/100 %

97577

97578



### 99341 ZAMUDILO

ceiling light; steel, white / plastic with crystal effect, white, silver  
Deckenleuchte; Stahl, weiss / Kunststoff m. Kristalleffekt, weiss, silber  
plafonnier; acier, blanc / plastique avec effet cristal, blanc, argent

H 90, Ø 400

18W 1900lm remote

### 99342 ZAMUDILO

ceiling light; steel, white / plastic with crystal effect, white, silver  
Deckenleuchte; Stahl, weiss / Kunststoff m. Kristalleffekt, weiss, silber  
plafonnier; acier, blanc / plastique avec effet cristal, blanc, argent

H 90, Ø 500

24W 2800lm remote

### 97577 SILERAS

wall / ceiling light; steel, white / plastic with crystal effect, white  
Wand- / Deckenleuchte; Stahl, weiss / Kunststoff m. Kristalleffekt, weiss  
applique / plafonnier; acier, blanc / plastique avec effet cristal, blanc

H 85, Ø 450

21W 2500lm remote



9 002759 993412



Ø 400



9 002759 993429



Ø 500



9 002759 975777



Ø 450



97578



99109



99108



### 97578 SILERAS

wall / ceiling light; steel, white / plastic with crystal effect, white  
Wand- / Deckenleuchte; Stahl, weiss / Kunststoff m. Kristalleffekt, weiss  
applique / plafonnier; acier, blanc / plastique avec effet cristal, blanc

H 85, Ø 600



34W 4600lm

remote

### 99108 RUIDERA

ceiling light; steel, white / plastic, white, silver  
Deckenleuchte; Stahl, weiss / Kunststoff, weiss, silber  
plafonnier; acier, blanc / plastique, blanc, argent

H 90, Ø 480



22W 2400lm

### 99109 RUIDERA

ceiling light; steel, white / plastic, white, silver  
Deckenleuchte; Stahl, weiss / Kunststoff, weiss, silber  
plafonnier; acier, blanc / plastique, blanc, argent

L 480, B 480, H 90



22W 2400lm



9 002759 975784



Ø 600



9 002759 991081



Ø 480



9 002759 991098



L 480

B 480





95973



incl./inkl./inclus



### 95973 VOLTAGO 2

wall / ceiling light; steel, white / plastic with crystal effect, white  
 Wand- / Deckenleuchte; Stahl, weiss / Kunststoff m.Kristalleffekt, weiss  
 applique / plafonnier; acier, blanc / plastique avec effet cristal, blanc

H 125, Ø 580



30W



3500lm



remote

### 95971 VOLTAGO 2

wall / ceiling light; steel, white / plastic with crystal effect, white  
 Wand- / Deckenleuchte; Stahl, weiss / Kunststoff m.Kristalleffekt, weiss  
 applique / plafonnier; acier, blanc / plastique avec effet cristal, blanc

H 95, Ø 295



14W



1500lm



remote

### 95972 VOLTAGO 2

wall / ceiling light; steel, white / plastic with crystal effect, white  
 Wand- / Deckenleuchte; Stahl, weiss / Kunststoff m.Kristalleffekt, weiss  
 applique / plafonnier; acier, blanc / plastique avec effet cristal, blanc

H 105, Ø 380



20W



2500lm



remote



9 002759 959739



Ø 580



9 002759 959715



Ø 295



9 002759 959722



Ø 380



95971



95972



95975



95971

95972

95973

95975

STEP  
TUNABLE

2700 K  
4500 K  
6500 K

## 95975 VOLTAGO 2

wall / ceiling light; steel, white / plastic with crystal effect, white  
Wand- / Deckenleuchte; Stahl, weiss / Kunststoff m. Kristalleffekt, weiss  
applique / plafonnier; acier, blanc / plastique avec effet cristal, blanc

L 375, B 375, H 90



20W



2200lm



remote



9 002759 959753



## VOLTAGO 2

These luminaires come with an interesting glitter-effect.

Diese Leuchten sind mit einem interessanten Glitzer-Effekt ausgestattet.

Ces luminaires viennent avec un effet scintillant intéressant.



98323



incl./inkl./inclus



98324



incl./inkl./inclus



97737



incl./inkl./inclus

### 98323 LANCIANO 1

wall / ceiling light; steel, white, transparent / plastic with crystal effect, white, chrome

Wand- / Deckenleuchte; Stahl, weiss, transparent / Kunststoff m. Kristalleffekt, weiss, chrom

applique / plafonnier; acier, blanc, transparent / plastique avec effet cristal, blanc, chrome

H 75, Ø 400



24W



1900lm



remote

### 98324 LANCIANO 1

wall / ceiling light; steel, white, transparent / plastic with crystal effect, white, chrome

Wand- / Deckenleuchte; Stahl, weiss, transparent / Kunststoff m. Kristalleffekt, weiss, chrom

applique / plafonnier; acier, blanc, transparent / plastique avec effet cristal, blanc, chrome

H 80, Ø 560



36W



3300lm



remote

### 97737 LANCIANO

ceiling light; steel, plastic, white, transparent / plastic with crystal effect, white, silver

Deckenleuchte; Stahl, Kunststoff, weiss, transparent / Kunststoff m. Kristalleffekt, weiss, silber

plafonnier; acier, plastique, blanc, transparent / plastique avec effet cristal, blanc, argent

H 100, Ø 660



40W



4000lm



remote



9 002759 983239



Ø 400



9 002759 983246



Ø 560



9 002759 977375



Ø 660



97738

LED

incl./inkl./inclus

**97738 LANCIANO**





ceiling light; steel, white, transparent / plastic with crystal effect, white, silver

Deckenleuchte; Stahl, weiss, transparent / Kunststoff m. Kristalleffekt, weiss, silber

plafonnier; acier, blanc, transparent / plastique avec effet cristal, blanc, argent

H 105, Ø 860

 LED 80W	 tunable WHITE 7800lm	 remote	 CONTROL UNIT
---	---	---	--

 TUNABLE WHITE	 DIMMABLE	 TIMER FUNCTION	 NIGHT LIGHT FUNCTION
	10 - 100 %	off after 30sec.	

**98323**

**98324**

**97737**

**97738**





99344

LED



99343

LED

### 99344 BENARIBA

wall / ceiling light; steel, white / plastic, white  
Wand- / Deckenleuchte; Stahl, weiss / Kunststoff, weiss  
applique / plafonnier; acier, blanc / plastique, blanc

Ø 440

LED

warm  
WHITE  
2450lm



9 002759 993443



Ø 440

### 99343 BENARIBA

wall / ceiling light; steel, white / plastic, white  
Wand- / Deckenleuchte; Stahl, weiss / Kunststoff, weiss  
applique / plafonnier; acier, blanc / plastique, blanc

Ø 330

LED

warm  
WHITE  
2000lm



9 002759 993436



Ø 330

### 99465 BENARIBA

wall / ceiling light; steel, white / plastic, white  
Wand- / Deckenleuchte; Stahl, weiss / Kunststoff, weiss  
applique / plafonnier; acier, blanc / plastique, blanc

H 70, Ø 550

LED

warm  
WHITE  
4100lm



9 002759 994655



Ø 550





99465



96026



96025



### 96025 CAPASSO 1

wall / ceiling light; steel, white / plastic, white, chrome  
Wand- / Deckenleuchte; Stahl, weiss / Kunststoff, weiss, chrom  
applique / plafonnier; acier, blanc / plastique, blanc, chrome

H 70, Ø 340



23W 2500lm



9 002759 960254



Ø 340

### 96026 CAPASSO 1

wall / ceiling light; steel, white / plastic, white, chrome  
Wand- / Deckenleuchte; Stahl, weiss / Kunststoff, weiss, chrom  
applique / plafonnier; acier, blanc / plastique, blanc, chrome

H 70, Ø 400



24W 2600lm



9 002759 960261



Ø 400





99405

LED



95677

LED

### 99404 COMPETA 2

wall / ceiling light; steel, white / plastic, white, black, clear  
Wand- / Deckenleuchte; Stahl, weiss / Kunststoff, weiss, schwarz, klar  
applique / plafonnier; acier, blanc / plastique, blanc, noir, clair

H 85, Ø 335

LED

18W

warm  
WHITE

2000lm



9 002759 994044



### 99405 COMPETA 2

wall / ceiling light; steel, white / plastic, white, black, clear  
Wand- / Deckenleuchte; Stahl, weiss / Kunststoff, weiss, schwarz, klar  
applique / plafonnier; acier, blanc / plastique, blanc, noir, clair

L 340, B 340, H 75

LED

24W

warm  
WHITE

2600lm



9 002759 994051

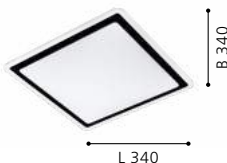

### 95677 COMPETA 1

wall / ceiling light; steel, white / plastic, white, silver, clear  
Wand- / Deckenleuchte; Stahl, weiss / Kunststoff, weiss, silber, klar  
applique / plafonnier; acier, blanc / plastique, blanc, argent, clair

H 75, Ø 335

LED

18W

warm  
WHITE

2000lm



9 002759 956776





**98258**

<b>TUNABLE WHITE</b>	<b>STEP DIMMING</b>
<ol style="list-style-type: none"> <li>warmwhite (2700K/100%)</li> <li>neutralwhite 3850K (2700K/50% + 5000K/50%)</li> <li>coldwhite (5000K/100%)</li> </ol>	
<b>TIMER FUNCTION</b>	<b>NIGHT LIGHT FUNCTION</b>
off after 30sec.	

**95679 COMPETA 1**

wall / ceiling light; steel, white / plastic, white, silver, clear  
 Wand- / Deckenleuchte; Stahl, weiss / Kunststoff, weiss, silber, klar  
 applique / plafonnier; acier, blanc / plastique, blanc, argent, clair

L 340, B 340, H 80



24W 2600lm

**95681 COMPETA 1**

wall / ceiling light; steel, white / plastic, white, silver, clear  
 Wand- / Deckenleuchte; Stahl, weiss / Kunststoff, weiss, silber, klar  
 applique / plafonnier; acier, blanc / plastique, blanc, argent, clair

L 430, B 430, H 95



24W 2600lm

**98258 COGOLETO**

wall / ceiling light; steel, plastic, white, silver / plastic, white  
 Wand- / Deckenleuchte; Stahl, Kunststoff, weiss, silber / Kunststoff, weiss  
 applique / plafonnier; acier, plastique, blanc, argent / plastique, blanc

L 490, B 490, H 60



30W 3200lm

remote



9 002759 956790



9 002759 956813



9 002759 982584





96032



96033



96034



### 96032 COMPETA 1

wall / ceiling light; steel, white / plastic, white, satined nickel  
Wand- / Deckenleuchte; Stahl, weiss / Kunststoff, weiss, nickel-  
matt  
applique / plafonnier; acier, blanc / plastique, blanc, nickel mat

H 55, Ø 245



18W



2000lm



### 96033 COMPETA 1

wall / ceiling light; steel, white / plastic, white, satined nickel  
Wand- / Deckenleuchte; Stahl, weiss / Kunststoff, weiss, nickel-  
matt  
applique / plafonnier; acier, blanc / plastique, blanc, nickel mat

H 55, Ø 325



23W



2500lm



### 96034 COMPETA 1

wall / ceiling light; steel, white / plastic, white, satined nickel  
Wand- / Deckenleuchte; Stahl, weiss / Kunststoff, weiss, nickel-  
matt  
applique / plafonnier; acier, blanc / plastique, blanc, nickel mat

H 55, Ø 430



24W



2600lm



9 002759 960322



Ø 245



9 002759 960339



Ø 325



9 002759 960346



Ø 430



95682



95684



### 95682 PALERMO 2

wall / ceiling light; steel, white / plastic, white, chrome  
Wand- / Deckenleuchte; Stahl, weiss / Kunststoff, weiss, chrom  
applique / plafonnier; acier, blanc / plastique, blanc, chrome

H 70, Ø 280



18W 2000lm



9 002759 956820



Ø 280

### 95684 PALERMO 2

wall / ceiling light; steel, white / plastic, white, chrome  
Wand- / Deckenleuchte; Stahl, weiss / Kunststoff, weiss, chrom  
applique / plafonnier; acier, blanc / plastique, blanc, chrome

H 60, Ø 410



24W 2600lm



9 002759 956844



Ø 410





96023

LED



98326

LED



96024

LED

### 96023 CAPASSO

wall / ceiling light; steel, white / plastic, white, chrome  
Wand- / Deckenleuchte; Stahl, weiss / Kunststoff, weiss, chrom  
applique / plafonnier; acier, blanc / plastique, blanc, chrome

H 65, Ø 340

LED

warm  
WHITE  
2500lm



9 002759 960230



Ø 340

### 96024 CAPASSO

wall / ceiling light; steel, white / plastic, white, chrome  
Wand- / Deckenleuchte; Stahl, weiss / Kunststoff, weiss, chrom  
applique / plafonnier; acier, blanc / plastique, blanc, chrome

H 70, Ø 400

LED

warm  
WHITE  
2600lm



9 002759 960247



Ø 400

### 98326 NIEVES

wall / ceiling light; steel, white / plastic, white, silver  
Wand- / Deckenleuchte; Stahl, weiss / Kunststoff, weiss, silber  
applique / plafonnier; acier, blanc / plastique, blanc, argent

H 70, Ø 510

LED

warm  
WHITE  
3700lm



9 002759 983260



Ø 510

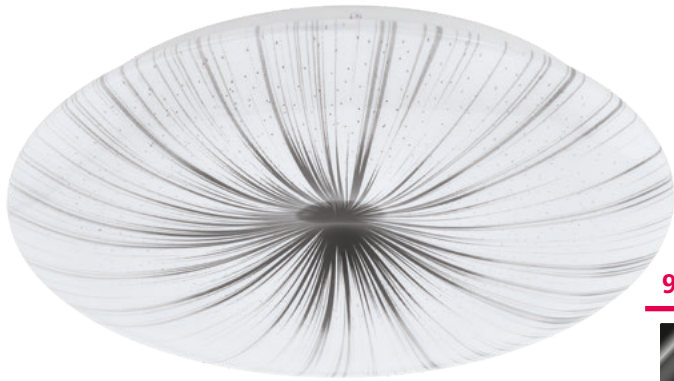

98325

LED



99699

### 98325 NIEVES

wall / ceiling light; steel, white / plastic, white, silver  
Wand- / Deckenleuchte; Stahl, weiss / Kunststoff, weiss, silber  
applique / plafonnier; acier, blanc / plastique, blanc, argent

H 65, Ø 410



24W 2400lm



9 002759 983253



Ø 410

### 99699 NIEVES

wall / ceiling light; steel, white / plastic, white, silver  
Wand- / Deckenleuchte; Stahl, weiss / Kunststoff, weiss, silber  
applique / plafonnier; acier, blanc / plastique, blanc, argent

H 60, Ø 310



11W 1350lm



9 002759 996994



Ø 310





99406



99407



98603



### 99406 PESCAITO

wall / ceiling light; steel, black / plastic, white, gold  
Wand- / Deckenleuchte; Stahl, schwarz / Kunststoff, weiss, gold  
applique / plafonnier; acier, noir / plastique, blanc, or

H 65, Ø 280



11W 1350lm

### 99407 PESCAITO

wall / ceiling light; steel, black / plastic, white, gold  
Wand- / Deckenleuchte; Stahl, schwarz / Kunststoff, weiss, gold  
applique / plafonnier; acier, noir / plastique, blanc, or

H 65, Ø 380



24W 2400lm

### 98603 MUSURITA

ceiling light; plastic, steel, black / plastic, white  
Deckenleuchte; Kunststoff, Stahl, schwarz / Kunststoff, weiss  
plafonnier; plastique, acier, noir / plastique, blanc

H 60, Ø 340



16,8W 2000lm



9 002759 994068



Ø 280



9 002759 994075



Ø 380



9 002759 986032



Ø 340



98604



98602



98601

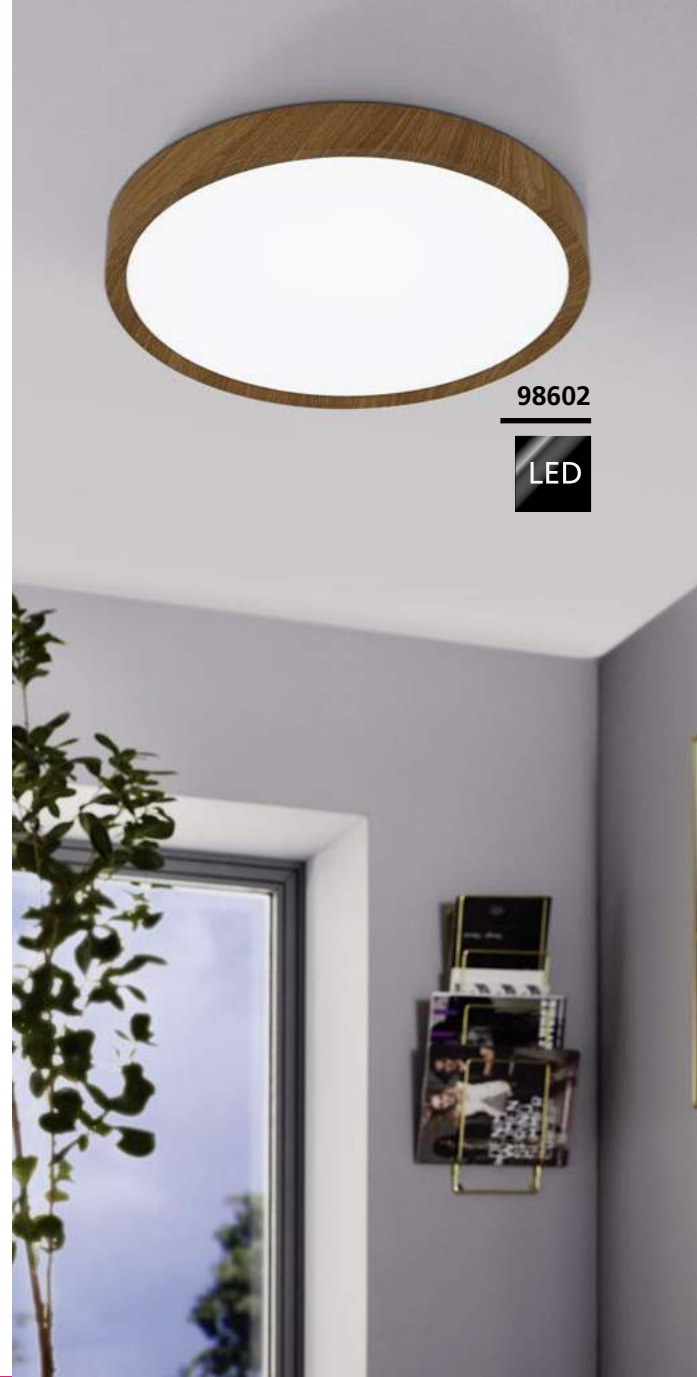

### 98604 MUSURITA

ceiling light; plastic, steel, black / plastic, white  
Deckenleuchte; Kunststoff, Stahl, schwarz / Kunststoff, weiss  
plafonnier; plastique, acier, noir / plastique, blanc

H 75, Ø 440



33,5W 3900lm

### 98601 MUSURITA

ceiling light; plastic, steel, natural wood look / plastic, white  
Deckenleuchte; Kunststoff, Stahl, Holzoptik natur / Kunststoff, weiss  
plafonnier; plastique, acier, aspect bois naturel / plastique, blanc

H 60, Ø 340



16,8W 2000lm

### 98602 MUSURITA

ceiling light; plastic, steel, natural wood look / plastic, white  
Deckenleuchte; Kunststoff, Stahl, Holzoptik natur / Kunststoff, weiss  
plafonnier; plastique, acier, aspect bois naturel / plastique, blanc

H 75, Ø 440



33,5W 3900lm



9 002759 986049



Ø 440



9 002759 986018



Ø 340



9 002759 986025



Ø 440



99782



99783



99779



### 99782 LAURITO

ceiling light; steel, white / plastic, grey, white  
Deckenleuchte; Stahl, weiss / Kunststoff, grau, weiss  
plafonnier; acier, blanc / plastique, gris, blanc

Ø 490



### 99783 LAURITO

ceiling light; steel, white / plastic, black, white  
Deckenleuchte; Stahl, weiss / Kunststoff, schwarz, weiss  
plafonnier; acier, blanc / plastique, noir, blanc

Ø 490



### 99779 SELUCI

ceiling light; steel, white / plastic, white, clear  
Deckenleuchte; Stahl, weiss / Kunststoff, weiss, klar  
plafonnier; acier, blanc / plastique, blanc, clair

H 70, Ø 490

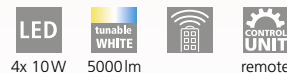





99781

LED



incl./inkl./inclus

### 99781 SELUCI

ceiling light; steel, black / plastic, white, clear  
Deckenleuchte; Stahl, schwarz / Kunststoff, weiss, klar  
plafonnier; acier, noir / plastique, blanc, clair

H 70, Ø 490

LED

4x 10W

tunable  
WHITE

5000lm



CONTROL  
UNIT

remote



9 002759 997816



Ø 490

### SELUCI

Convenient light effect due to the indirect illumination.

Angenehmer Lichteffect durch indirekte Beleuchtung.

Effet de lumière pratique en raison de l'éclairage indirect.



99623



99621



99622



### 99623 VALCASOTTO

ceiling light; steel, Mokka colour / plastic, white  
Deckenleuchte; Stahl, Mokkafarben / Kunststoff, weiss  
plafonnier; acier, mocha couleur / plastique, blanc

H 75, Ø 350



24W



2050lm



9 002759 996239



Ø 350

### 99621 VALCASOTTO

ceiling light; steel, black / plastic, white  
Deckenleuchte; Stahl, schwarz / Kunststoff, weiss  
plafonnier; acier, noir / plastique, blanc

H 75, Ø 350



24W



2050lm



9 002759 996215



Ø 350

### 99622 VALCASOTTO

ceiling light; steel, brown / plastic, white  
Deckenleuchte; Stahl, braun / Kunststoff, weiss  
plafonnier; acier, marron / plastique, blanc

H 75, Ø 350



24W



2050lm



9 002759 996222



Ø 350



99703



99704



**99704 PENJAMO**

ceiling light; steel, Mokka colour / plastic with crystal effect, white  
Deckenleuchte; Stahl, Mokkafarben / Kunststoff m. Kristalleffekt, weiss  
plafonnier; acier, mocha couleur / plastique avec effet cristal, blanc  
H 65, Ø 465



**99703 PENJAMO**

ceiling light; steel, black / plastic with crystal effect, white  
Deckenleuchte; Stahl, schwarz / Kunststoff m. Kristalleffekt, weiss  
plafonnier; acier, noir / plastique avec effet cristal, blanc  
H 65, Ø 465





99397



99397

The wall switch controls the luminaire's light colour.

Über den Wandschalter kann die Lichtfarbe der Leuchte gesteuert werden.

La couleur de lumière du luminaire peut être commandée par l'interrupteur mural.



99398



99398

The wall switch controls the luminaire's light colour.

Über den Wandschalter kann die Lichtfarbe der Leuchte gesteuert werden.

La couleur de lumière du luminaire peut être commandée par l'interrupteur mural.

### 99397 MENTALURGIA

wall / ceiling light; steel, white, chrome / plastic, white  
Wand- / Deckenleuchte; Stahl, weiss, chrom / Kunststoff, weiss  
applique / plafonnier; acier, blanc, chrome / plastique, blanc

L 495, B 465, H 65



9 002759 993979



L 495

### 99398 MENTALURGIA

wall / ceiling light; steel, white, chrome / plastic, white  
Wand- / Deckenleuchte; Stahl, weiss, chrom / Kunststoff, weiss  
applique / plafonnier; acier, blanc, chrome / plastique, blanc

L 490, B 490, H 65



9 002759 993986



L 490



99399

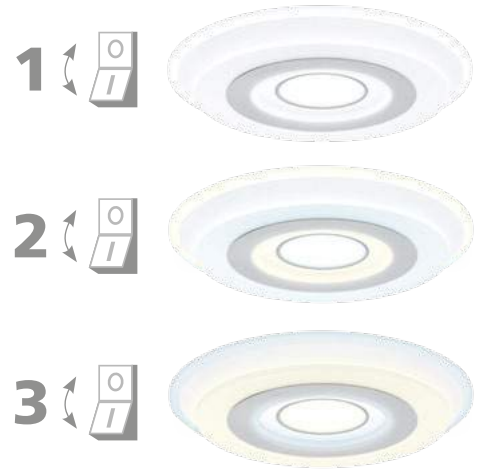

### 99399

The wall switch controls the luminaire's light colour.

Über den Wandschalter kann die Lichtfarbe der Leuchte gesteuert werden.

La couleur de lumière du luminaire peut être commandée par l'interrupteur mural.



95487



96851



### 99399 REDUCTA 2

wall / ceiling light; plastic, white  
Wand- / Deckenleuchte; Kunststoff, weiss  
applique / plafonnier; plastique, blanc

H 45, Ø 490



9 002759 993993



### 96851 LEGANES

ceiling light; steel, white / plastic, white  
Deckenleuchte; Stahl, weiss / Kunststoff, weiss  
plafonnier; acier, blanc / plastique, blanc

H 110, Ø 455



9 002759 968519



### 95487 TORONJA

ceiling light; steel, white  
Deckenleuchte; Stahl, weiss  
plafonnier; acier, blanc

H 205, Ø 550



9 002759 954871







**81635**



**83404**



**81636**

**81635 ELLA**

wall / ceiling light; steel, white / glass opal-matt, white  
Wand- / Deckenleuchte; Stahl, weiss / Glas opal-matt, weiss  
applique / plafonnier; acier, blanc / verre opale mat, blanc

H 92, Ø 200



E27

1x 60W

**81636 ELLA**

wall / ceiling light; steel, white / glass opal-matt, white  
Wand- / Deckenleuchte; Stahl, weiss / Glas opal-matt, weiss  
applique / plafonnier; acier, blanc / verre opale mat, blanc

H 117, Ø 280



E27

1x 60W

**83404 ELLA**

wall / ceiling light; steel, white / glass opal-matt, white  
Wand- / Deckenleuchte; Stahl, weiss / Glas opal-matt, weiss  
applique / plafonnier; acier, blanc / verre opale mat, blanc

H 127, Ø 350



E27

2x 60W



9 002759 816353



Ø 200



9 002759 816360



Ø 280



9 002759 834043



Ø 350



**94973**

### 94973 DURELO

ceiling light; plastic, white / glass, white  
Deckenleuchte; Kunststoff, weiss / Glas, weiss  
plafonnier; plastique, blanc / verre, blanc

H 195, Ø 160



E27



1x 28W



9 002759 949730





**82944**



**82942**

### 82944 PLANET

wall / ceiling light; steel, chrome / satin glass, white, clear  
Wand- / Deckenleuchte; Stahl, chrom / Glas satiniert, weiss, klar  
applique / plafonnier; acier, chrome / verre satiné, blanc, clair

H 100, Ø 370



E27

2x 25W

### 82942 PLANET

wall / ceiling light; steel, satin nickel / satin glass, white, clear  
Wand- / Deckenleuchte; Stahl, nickel-matt / Glas satiniert, weiss, klar  
applique / plafonnier; acier, nickel mat / verre satiné, blanc, clair

H 85, Ø 290



E27

1x 25W

### 31254 LED PLANET

wall / ceiling light; steel, satin nickel / satin glass, white, clear  
Wand- / Deckenleuchte; Stahl, nickel-matt / Glas satiniert, weiss, klar  
applique / plafonnier; acier, nickel mat / verre satiné, blanc, clair

H 85, Ø 290



11W



950lm



9 002759 829445



Ø 370



9 002759 829421



Ø 290



9 002759 312541



Ø 290



31254

LED



**83155**



### **83155 PLANET 1**

wall / ceiling light; steel, chrome / glass painted, white, clear  
Wand- / Deckenleuchte; Stahl, chrom / Glas lackiert, weiss, klar  
applique / plafonnier; acier, chrome / verre laqué, blanc, clair

H 85, Ø 290



E27



1x 25W



9 002759 831554



Ø 290





83153



83154



83156

### 83156 PLANET 1

wall light; steel, chrome / glass painted, white, clear  
Wandleuchte; Stahl, chrom / Glas lackiert, weiss, klar  
applique; acier, chrome / verre laqué, blanc, clair

L 290, H 145, A 85



E27 1x 60W



9 002759 831561



L 290

H 145

### 83153 PLANET 1

wall / ceiling light; steel, white / glass painted, white, clear  
Wand- / Deckenleuchte; Stahl, weiss / Glas lackiert, weiss, klar  
applique / plafonnier; acier, blanc / verre laqué, blanc, clair

H 85, Ø 290



E27 1x 25W



9 002759 831530



Ø 290

H 85

### 83154 PLANET 1

wall light; steel, white / glass painted, white, clear  
Wandleuchte; Stahl, weiss / Glas lackiert, weiss, klar  
applique; acier, blanc / verre laqué, blanc, clair

L 290, H 145, A 85



E27 1x 60W



9 002759 831547



L 290

H 145



**83157**



**83159**

**83157 PLANET 1**

wall / ceiling light; steel, brass / glass painted, white, clear  
Wand- / Deckenleuchte; Stahl, messing / Glas lackiert, weiss, klar  
applique / plafonnier; acier, laiton / verre laqué, blanc, clair

H 85, Ø 290



E27

1x 25W



9 002759 831578



Ø 290

**83159 PLANET 1**

wall / ceiling light; steel, black / glass painted, white, clear  
Wand- / Deckenleuchte; Stahl, schwarz / Glas lackiert, weiss, klar  
applique / plafonnier; acier, noir / verre laqué, blanc, clair

H 85, Ø 290



E27

1x 25W



9 002759 831592



Ø 290

**83162 PLANET 1**

wall / ceiling light; steel, satin nickel / glass painted, white, clear  
Wand- / Deckenleuchte; Stahl, nickel-matt / Glas lackiert, weiss, klar  
applique / plafonnier; acier, nickel mat / verre laqué, blanc, clair

H 85, Ø 290



E27

1x 25W



9 002759 831622



Ø 290



**83162**



**83163**

### 83163 PLANET 1

wall light; steel, satin nickel / glass painted, white, clear  
Wandleuchte; Stahl, nickel-matt / Glas lackiert, weiss, klar  
applique; acier, nickel mat / verre laqué, blanc, clair

L 290, H 145, A 85



E27



1x 60W



9 002759 831639





96117



95675



95288



### 95675 RICONTO 1

wall / ceiling light; steel, white / glass fluted, white, clear  
Wand- / Deckenleuchte; Stahl, weiss / Glas geriffelt, weiss, klar  
applique / plafonnier; acier, blanc / verre cannelé, blanc, clair

H 70, Ø 250



9 002759 956752



Ø 250

### 95288 RICONTO 1

wall / ceiling light; steel, white / glass fluted, white, clear  
Wand- / Deckenleuchte; Stahl, weiss / Glas geriffelt, weiss, klar  
applique / plafonnier; acier, blanc / verre cannelé, blanc, clair

H 95, Ø 315



9 002759 952884



Ø 315

### 96117 MARGITTA 1

wall / ceiling light; steel, white / glass, white, black, clear  
Wand- / Deckenleuchte; Stahl, weiss / Glas, weiss, schwarz, klar  
applique / plafonnier; acier, blanc / verre, blanc, noir, clair

H 95, Ø 315



9 002759 961176



Ø 315



96089

LED



96111

LED



96472

LED



### 96089 MARGITTA 1

wall / ceiling light; steel, white / glass, granille white, clear  
Wand- / Deckenleuchte; Stahl, weiss / Glas, granille weiss, klar  
applique / plafonnier; acier, blanc / verre, blanc granille, clair

H 70, Ø 250



11W 950lm



9 002759 960896



Ø 250

### 96111 MARGITTA 1

wall / ceiling light; steel, white / glass, granille white, clear  
Wand- / Deckenleuchte; Stahl, weiss / Glas, granille weiss, klar  
applique / plafonnier; acier, blanc / verre, blanc granille, clair

H 95, Ø 315



11W 950lm



9 002759 961114



Ø 315

### 96472 VEREDA

wall / ceiling light; steel, white / glass, granille white, clear  
Wand- / Deckenleuchte; Stahl, weiss / Glas, granille weiss, klar  
applique / plafonnier; acier, blanc / verre, blanc granille, clair

H 95, Ø 315



11W 950lm



9 002759 964726

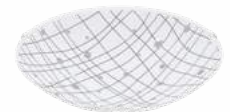

Ø 315





91236



89239



90043

### 91236 MARS

wall / ceiling light; steel, white / satin glass, white with decor  
Wand- / Deckenleuchte; Stahl, weiss / Glas satiniert, weiss m. Dekor  
applique / plafonnier; acier, blanc / verre satiné, blanc avec décor

H 70, Ø 250



E27 1x 60W

### 90043 SCALEA 1

wall / ceiling light; steel, white / satin glass, white with decor  
Wand- / Deckenleuchte; Stahl, weiss / Glas satiniert, weiss m. Dekor  
applique / plafonnier; acier, blanc / verre satiné, blanc avec décor

H 100, Ø 315



E27 1x 25W

### 89239 MARS 1

wall / ceiling light; steel, white / satin glass, design "beams"  
Wand- / Deckenleuchte; Stahl, weiss / Glas satiniert, Motiv Strahlen  
applique / plafonnier; acier, blanc / verre satiné, motif «rayons»

H 70, Ø 250



E27 1x 25W



9 002759 912369



Ø 250



9 002759 900434



Ø 315



9 002759 892395



Ø 250



**80263**



**80264**



**89238**

### 80264 MARS

wall / ceiling light; steel, white / satin glass, design "leaves"  
 Wand- / Deckenleuchte; Stahl, weiss / Glas satiniert, Motiv Blätter  
 applique / plafonnier; acier, blanc / verre satiné, motif «feuilles»

H 70, Ø 250



E27 1x 25W



9 002759 802646



Ø 250

### 80263 MARS

wall / ceiling light; steel, white / satin glass, design "triangles"  
 Wand- / Deckenleuchte; Stahl, weiss / Glas satiniert, Motiv Dreiecke  
 applique / plafonnier; acier, blanc / verre satiné, motif «triangles»

H 70, Ø 250



E27 1x 25W



9 002759 802639



Ø 250

### 89238 MARS 1

wall / ceiling light; steel, white / satin glass, design "rose"  
 Wand- / Deckenleuchte; Stahl, weiss / Glas satiniert, Motiv Rose  
 applique / plafonnier; acier, blanc / verre satiné, motif «rose»

H 70, Ø 250



E27 1x 25W



9 002759 892388



Ø 250



95672



89248

### 95672 MAGITTA 1

wall / ceiling light; steel, white / glass, white, clear  
Wand- / Deckenleuchte; Stahl, weiss / Glas, weiss, klar  
applique / plafonnier; acier, blanc / verre, blanc, clair

H 80, Ø 250



11W



950lm



### 89248 MARS 1

wall / ceiling light; steel, white / satin glass, white, silver  
Wand- / Deckenleuchte; Stahl, weiss / Glas satiniert, weiss, silber  
applique / plafonnier; acier, blanc / verre satiné, blanc, argent

H 70, Ø 250



E27



1x 25W

### 89758 RAYA

wall / ceiling light; steel, white, chrome / satin glass, white, silver  
Wand- / Deckenleuchte; Stahl, weiss, chrom / Glas satiniert, weiss, silber  
applique / plafonnier; acier, blanc, chrome / verre satiné, blanc, argent

H 100, Ø 315



E27



1x 25W



9 002759 956721



Ø 250



9 002759 892487



Ø 250



9 002759 897581



Ø 315



89758



**83132**



GL-901

**84028**

### 83132 GRAFIK

wall / ceiling light; steel / satin glass, design "lines"  
Wand- / Deckenleuchte; Stahl / Glas satiniert, Motiv Linien  
applique / plafonnier; acier / verre satiné, motif «lignes»

L 180, H 210, A 85



E27

1x 60W



9 002759 831325



L 180

H 210

### 84028 GRAFIK

wall / ceiling light; steel, silver / satin glass, white  
Wand- / Deckenleuchte; Stahl, silber / Glas satiniert, weiss  
applique / plafonnier; acier, argent / verre satiné, blanc

L 180, H 210, A 85



E27

1x 60W



9 002759 840280



L 180

H 210

### 83119 NEMO

wall light; steel, satin nickel / glass opal-matt, white  
Wandleuchte; Stahl, nickel-matt / Glas opal-matt, weiss  
applique; acier, nickel mat / verre opale mat, blanc

L 150, H 320, A 95



E27

1x 25W



9 002759 831196



L 150

H 320





83119



7186



80265



7184

### 80265 MARS

wall / ceiling light; steel, white / satin glass, white  
Wand- / Deckenleuchte; Stahl, weiss / Glas satiniert, weiss  
applique / plafonnier; acier, blanc / verre satiné, blanc

H 70, Ø 250



E27



1x 25W



9 002759 802653



Ø 250

### 7186 SALOME

wall / ceiling light; steel, chrome / glass alabaster, white  
Wand- / Deckenleuchte; Stahl, chrom / Glas alabaster, weiss  
applique / plafonnier; acier, chrome / verre albâtre, blanc

H 90, Ø 300



E27



1x 25W



9 002759 718602



Ø 300

### 7184 SALOME

wall / ceiling light; steel, chrome / glass alabaster, white  
Wand- / Deckenleuchte; Stahl, chrom / Glas alabaster, weiss  
applique / plafonnier; acier, chrome / verre albâtre, blanc

H 110, Ø 400



E27



2x 25W



9 002759 718404



Ø 400



7188

### 7188 SALOME

wall light; steel, chrome / glass alabaster, white  
Wandleuchte; Stahl, chrom / Glas alabaster, weiss  
applique; acier, chrome / verre albâtre, blanc

L 300, H 150, A 90



E27



1x 60W



9 002759 718800



### SALOME

These luminaires have a beautiful alabaster glass.

Diese Leuchten besitzen ein wunderschönes Alabasterglas.

Ces luminaires ont un beau verre d'albâtre.





## MALVA

This luminaire comes with a hand-made glass with a special wipe technique.

Diese Leuchte besitzt ein handgemachtes Glas mit spezieller Wischtechnik.

Cette luminaire viens avec un verre de luxe faitmain avec un technique à l'essuyé.



90015



86712



82741

### 90015 MALVA

wall / ceiling light; steel, white / glass wiping technique, beige  
Wand- / Deckenleuchte; Stahl, weiss / Glas Wischtechnik, beige  
applique / plafonnier; acier, blanc / technique d'essuie de verre, beige

H 95, Ø 315



E27

1x 25W

### 86712 MESTRE

wall / ceiling light; steel, antique-brown, gold / glass chalked, beige  
Wand- / Deckenleuchte; Stahl, antik-braun, gold / Glas gekalkt, beige  
applique / plafonnier; acier, marron antique, or / verre chaulé, beige

H 133, Ø 395



E27

2x 60W

### 82741 IMPERIAL

wall / ceiling light; cast metal, bronzed / satin glass, white  
Wand- / Deckenleuchte; Metallguss, brüniert / Glas satiniert, weiss  
applique / plafonnier; fonte métallique, bruni / verre satiné, blanc

H 140, Ø 310



E27

2x 25W



9 002759 900151



Ø 315



9 002759 867126



Ø 395



9 002759 827410



Ø 310

H 140



86715



GL1932

89115



87793

### 89115 ALMERA

wall light; steel, antique-brown / glass, champagne  
Wandleuchte; Stahl, antik-braun / Glas, champagner  
applique; acier, marron antique / verre, champagne

L 180, H 250, A 75



E14



1x 60W



9 002759 891152



L 180

H 250

### 86715 MESTRE

wall light; steel, antique-brown, gold / glass chalked, beige  
Wandleuchte; Stahl, antik-braun, gold / Glas gekalkt, beige  
applique; acier, marron antique, or / verre chaulé, beige

L 300, H 335, A 160



E27



1x 60W



9 002759 867157



L 300

H 335

### 87793 PASCAL 1

wall light; steel, antique-brown / glass chalked, beige  
Wandleuchte; Stahl, antik-braun / Glas gekalkt, beige  
applique; acier, marron antique / verre chaulé, beige

L 180, H 480, A 120



E14



1x 60W



9 002759 877934



L 180

H 480





90737

90737, 90697

Rustic luminaire series with appealing leaf decor

Rustikale Leuchtenserie mit ansprechendem Blätterdekor

Série de luminaires rustique avec un décor de feuille plaisant



90697

### 90737 CAMPANIA

ceiling light; steel, antique-brown, gold / glass chalked, white  
Deckenleuchte; Stahl, antik-braun, gold / Glas gekalkt, weiss  
plafonnier; acier, marron antique, or / verre chaulé, blanc

H 115, Ø 775



G4 15x 10W

### 90697 GERBERA 1

ceiling light; steel, antique-brown, gold / satin glass, white  
Deckenleuchte; Stahl, antik-braun, gold / Glas satiniert, weiss  
plafonnier; acier, marron antique, or / verre satiné, blanc

H 90, Ø 780



G9 6x 33W

### 92143 COLTI

ceiling light; steel, antique-brown / satin glass, white painted  
Deckenleuchte; Stahl, antik-braun / Glas satiniert, weiss lackiert  
plafonnier; acier, marron antique / verre satiné, blanc laqué

H 95, Ø 350



E27 2x 25W



9 002759 907372



Ø 775



9 002759 906979



Ø 780



9 002759 921439



Ø 350



92143



**99349**



**97886**



**99348**

Matching fabric luminaires can be found from page 100.

Passende Stoffleuchten finden Sie ab Seite 100.

Vous trouverez les luminaires à textile assorties à partir de la page 100.

### 99349 TABILLANO 1

wall light; steel, black  
Wandleuchte; Stahl, schwarz  
applique; acier, noir

L 160, H 250, A 500



E27 1x 40W

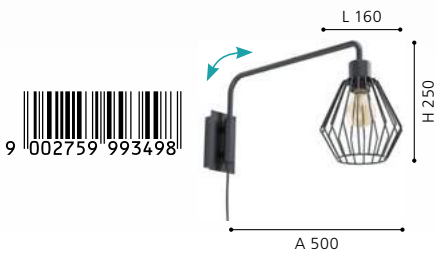

9 002759 993498

### 97886 SAN PERI

wall light; steel, black  
Wandleuchte; Stahl, schwarz  
applique; acier, noir

L 130, B 300, H 210



E27 1x 10W

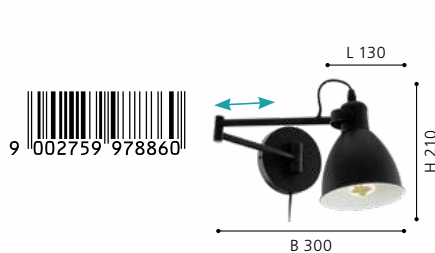

9 002759 978860

### 99348 STAITI 1

wall light; steel, black / fabric, black  
Wandleuchte; Stahl, schwarz / Textil, schwarz  
applique; acier, noir / tissu, noir

L 160, H 240, A 500



E27 1x 40W

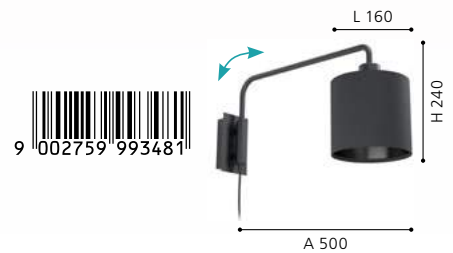

9 002759 993481



**99348**





99069

LED



99126

LED



## GALDAKAO

These luminaires have a shelf.

Diese Leuchten verfügen über eine Ablagefläche.

Ces luminaires ont une étagère.

### 99069 GALDAKAO

wall light; steel, black / fabric, white  
Wandleuchte; Stahl, schwarz / Textil, weiss  
applique; acier, noir / tissu, blanc

L 200, H 320, A 125



9 002759 990695



### 99126 GALDAKAO

wall light; steel, wood, black, natural / fabric, white  
Wandleuchte; Stahl, Holz, schwarz, natur / Textil, weiss  
applique; acier, bois, noir, nature / tissu, blanc

L 200, H 350, A 135, Base: B 200, T 125



9 002759 991265







Qi Charger



98263

LED



98265

98265



Qi Charger



### 98263 CIGLIE

wall light; aluminium, steel, black  
Wandleuchte; Alu, Stahl, schwarz  
applique; aluminium, acier, noir

L 180, H 180, A 210

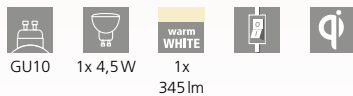

L 180



H 180

A 210



9 002759 982638



### 98265 CIGLIE

wall light; cast aluminium, black / glass opal-matt, white  
Wandleuchte; Aluguss, schwarz / Glas opal-matt, weiss  
applique; fonte d'aluminium, noir / verre opale mat, blanc

L 180, H 180, A 210



L 180



H 180

A 210



9 002759 982652



### CIGLIE

These luminaires have a Qi charging function. They can wirelessly charge Qi-compatible Smartphones by inductive energy transfer.

Diese Leuchten besitzen eine Qi-Ladefunktion. Damit können Qi-kompatible Smartphones über induktive Energieübertragung kabellos geladen werden.

Ces luminaires disposent d'une fonction de chargement Qi. Cela permet aux smartphones compatibles Qi d'être chargés sans fil par transmission d'énergie inductive.



99595

LED

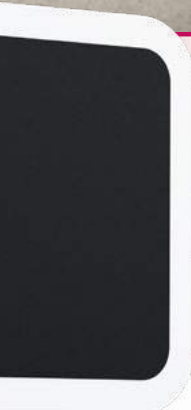

CARTIGNANO

**99595 CARTIGNANO**

wall light; steel, black / plastic, white  
Wandleuchte; Stahl, schwarz / Kunststoff, weiss  
applique; acier, noir / plastique, blanc

L 780, H 180, A 35

LED  
7,8W

warm  
WHITE  
920lm



This sleek, modern luminaire is multifunctional, providing illumination and a handy coat rack feature. It can be mounted directly on a wall outlet, and a cord with switch is included in your deliver.

Diese schlichte, moderne Leuchte dient nicht nur als Lichtquelle, sondern auch als Garderobe. Sie kann direkt im Wandauslass montiert werden, ein Kabel mit Schalter wird automatisch mitgeliefert.

Ce luminaire sobre et moderne peuvent non seulement servir de source de lumière, mais aussi de porte-manteau. Les deux lampes peuvent être directement montées sur une prise murale. Le câble avec interrupteur est inclus dans la livraison.





99596



## 99596 CIVITATE

wall light; steel, wood, black, brown  
Wandleuchte; Stahl, Holz, schwarz, braun  
applique; acier, bois, noir, marron

L 760, B 100, H 85



18W



1900lm



9 002759 995966



## CIVITATE

The CIVITATE LED wall luminaire features a rectangular, black metal body with rounded corners. Five brown, rubber-wood brackets provide space and support for coats and jackets, making this the ideal illuminated coat rack. The CIVITATE emits a warm, comfortable light, providing indirect illumination in your entrance area or foyer. The minimalist design complements a modern interior, and can easily be turned on and off with a switch on the cord.

Die LED Wandleuchte CIVITATE besteht aus einem rechteckigen, schwarzen Metall-Körper mit abgerundeten Ecken. Dank der fünf Halterungen aus braunem Gummibaumholz bietet die Wandlampe genügend Platz für Jacken sowie Mäntel und kann so optimal als beleuchtete Garderobe genutzt werden. Die Leuchte spendet angenehmes warmweißes Licht und schafft so eine indirekte Beleuchtung im Eingangsbereich. Die minimalistische Leuchte rundet moderne Einrichtungsstile ab und ist bequem über einen Schalter am Kabel ein- und ausschaltbar.

L'applique murale LED CIVITATE est composée d'un boîtier rectangulaire en métal noir avec des angles arrondis. Les cinq supports en bois d'hévéa brun permettent d'accrocher des vestes et des manteaux, ce qui permet à l'applique de servir également de porte-manteau. L'applique diffuse une lumière blanc chaud agréable, et ainsi un éclairage indirect pour les entrées. Minimaliste, elle complète des styles intérieurs modernes et peut être facilement actionnée grâce à l'interrupteur situé sur le câble.





## TAZZOLI

These luminaires have a USB-connection.

Diese Leuchten verfügen über einen USB-Anschluss.

Ces luminaires disposent d'une connexion USB.

### 96566 TAZZOLI

wall light; steel, plastic, white  
Wandleuchte; Stahl, Kunststoff, weiss  
applique; acier, plastique, blanc

L 65, H 300, A 160



3,5W 380lm



### 96567 TAZZOLI

wall light; steel, plastic, satin nickel, black  
Wandleuchte; Stahl, Kunststoff, nickel-matt, schwarz  
applique; acier, plastique, nickel mat, noir

L 65, H 300, A 160



3,5W 380lm



### 99689 GURARE

wall light; steel, schwarz, mokkafarben  
Wandleuchte; Stahl, schwarz, mokkafarben  
applique; acier, schwarz, mokkafarben

L 125, H 240, A 85



2x 2,5W 2x 180lm

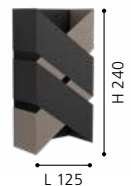

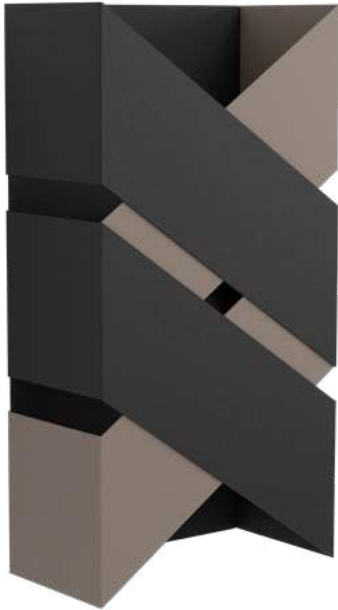

99689

LED



98841

LED

### 98841 ZINACUA

wall light; steel, silver  
Wandleuchte; Stahl, silber  
applique; acier, argent

L 225, H 310, A 85



GU10



4x 4,5 W



4x  
345 lm



9 002759 988418



INCL.

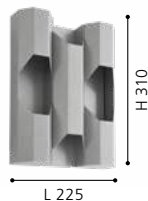





99087

LED



99086

LED

### 99087 ZUBIALDE

wall light; aluminium, steel, black, white  
Wandleuchte; Alu, Stahl, schwarz, weiss  
applique; aluminium, acier, noir, blanc

### 99086 ZUBIALDE

wall light; aluminium, steel, white  
Wandleuchte; Alu, Stahl, weiss  
applique; aluminium, acier, blanc

#### ZUBIALDE

The front plate of the luminaire can be swiveled. The light can be adjusted individually.

Die Frontplatte der Leuchte ist schwenkbar. Somit kann das Lichtbild individuell eingestellt werden.

La plaque frontale du luminaire peut être pivotée. La lumière peut être réglée individuellement.

L 360, H 80, A 50

LED  
12W

warm  
WHITE  
1400lm



L 360, H 80, A 50

LED  
12W

warm  
WHITE  
1400lm



9 002759 990879



9 002759 990862





96049



99112



96048



### 99112 BELATEGI

wall light; steel, black / glass vaporized, black-transparent, clear  
Wandleuchte; Stahl, schwarz / Glas bedampft, schwarz-transparent, klar  
applique; acier, noir / verre vaporisé, noir transparent, clair

Ø 240, A 180



E27 1x 40W



9 002759 991128



Ø 240

### 96049 ONO 2

wall light; aluminium, anthracite / plastic, clear  
Wandleuchte; Alu, anthrazit / Kunststoff, klar  
applique; aluminium, anthracite / plastique, clair

L 90, H 80, A 130



LED warm WHITE 2x 2,5W 460lm



9 002759 960490



A 130

### 96048 ONO 2

wall light; aluminium, white / plastic, clear  
Wandleuchte; Alu, weiss / Kunststoff, klar  
applique; aluminium, blanc / plastique, clair

L 90, H 80, A 130



LED warm WHITE 2x 2,5W 460lm



9 002759 960483



A 130



98542



98541



98543



### 98541 MACCARI

wall light; aluminium, steel, white / plastic, transparent  
Wandleuchte; Alu, Stahl, weiss / Kunststoff, transparent  
applique; aluminium, acier, blanc / plastique, transparent

L 270, H 75, A 130



10W 1100lm



9 002759 985417



L 270

### 98542 MACCARI

wall light; aluminium, steel, black, gold / plastic, transparent  
Wandleuchte; Alu, Stahl, schwarz, gold / Kunststoff, transparent  
applique; aluminium, acier, noir, or / plastique, transparent

L 270, H 75, A 130



10W 1100lm



9 002759 985424



L 270

### 98543 MACCARI

wall light; aluminium, steel, white, satin nickel / plastic, transparent  
Wandleuchte; Alu, Stahl, weiss, nickel-matt / Kunststoff, transparent  
applique; aluminium, acier, blanc, nickel mat / plastique, transparent

L 270, H 75, A 130



10W 1100lm



9 002759 985431



L 270



98544

LED



98545

LED

**98544 FELONICHE**

wall light; aluminium, white / plastic, transparent  
 Wandleuchte; Alu, weiss / Kunststoff, transparent  
 applique; aluminium, blanc / plastique, transparent

L 220, H 100, A 75



10W 1100lm

**98545 FELONICHE**

wall light; aluminium, black, gold / plastic, transparent  
 Wandleuchte; Alu, schwarz, gold / Kunststoff, transparent  
 applique; aluminium, noir, or / plastique, transparent

L 220, H 100, A 75



10W 1100lm



9 002759 985448

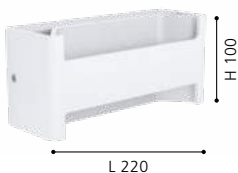

9 002759 985455

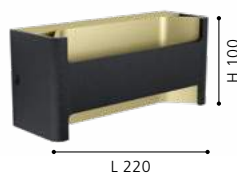



98421



98422



98423



**98421 SANIA 4**

wall light; aluminium, white  
Wandleuchte; Alu, weiss  
applique; aluminium, blanc

L 130, H 80, A 90



6W

600lm

**98422 SANIA 4**

wall light; aluminium, white  
Wandleuchte; Alu, weiss  
applique; aluminium, blanc

L 200, H 80, A 90



10W

1100lm

**98423 SANIA 4**

wall light; aluminium, white  
Wandleuchte; Alu, weiss  
applique; aluminium, blanc

L 365, H 80, A 90



12W

1400lm



9 002759 984212

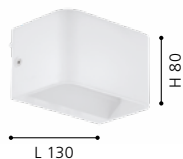

9 002759 984229

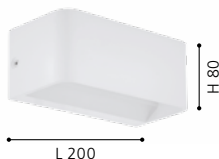

9 002759 984236

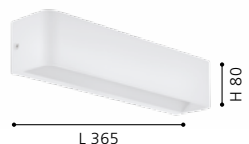





98424



98425



98426



### 98424 SANIA 4

wall light; aluminium, satin nickel  
Wandleuchte; Alu, nickel-matt  
applique; aluminium, nickel mat

L 130, H 80, A 90



6W 600lm



9 002759 984243

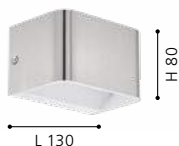

### 98425 SANIA 4

wall light; aluminium, satin nickel  
Wandleuchte; Alu, nickel-matt  
applique; aluminium, nickel mat

L 200, H 80, A 90



10W 1100lm



9 002759 984250



### 98426 SANIA 4

wall light; aluminium, satin nickel  
Wandleuchte; Alu, nickel-matt  
applique; aluminium, nickel mat

L 365, H 80, A 90



12W 1400lm



9 002759 984267





96261

LED



### 96261 PASSA

wall light; steel, satin nickel, chrome  
Wandleuchte; Stahl, nickel-matt, chrom  
applique; acier, nickel mat, chrome

L 60, H 170, A 85



GU10



2x 3W



warm  
WHITE

2x

250lm



9 002759 962616



INCL.





96264

LED



95368

LED



95377

LED

### 96264 PASSA

wall light; steel, satin nickel, chrome  
Wandleuchte; Stahl, nickel-matt, chrom  
applique; acier, nickel mat, chrome

L 55, H 170, A 85



GU10



2x 3W



warm  
WHITE  
2x  
250lm



9 002759 962647



### 95368 PASSA

wall light; steel, chrome, white  
Wandleuchte; Stahl, chrom, weiss  
applique; acier, chrome, blanc

L 60, H 170, A 85



GU10



2x 3W



warm  
WHITE  
2x  
250lm



9 002759 953683



### 95377 PASSA

wall light; steel, chrome, white  
Wandleuchte; Stahl, chrom, weiss  
applique; acier, chrome, blanc

L 55, H 170, A 85



GU10



2x 3W



warm  
WHITE  
2x  
250lm



9 002759 953775





95371

LED



95379

LED

### 95371 PASSA

wall light; steel, brown, copper  
Wandleuchte; Stahl, braun, kupfer  
applique; acier, marron, cuivre

L 60, H 170, A 85

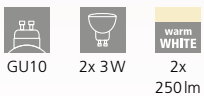

9 002759 953713

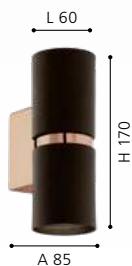

### 95379 PASSA

wall light; steel, brown, copper  
Wandleuchte; Stahl, braun, kupfer  
applique; acier, marron, cuivre

L 55, H 170, A 85

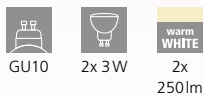

9 002759 953799



### 95364 PASSA

wall light; steel, black, gold  
Wandleuchte; Stahl, schwarz, gold  
applique; acier, noir, or

L 60, H 170, A 85

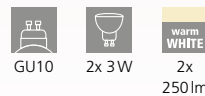

9 002759 953645





95364

LED



95373

LED

### 95373 PASSA

wall light; steel, black, gold  
Wandleuchte; Stahl, schwarz, gold  
applique; acier, noir, or

L 55, H 170, A 85



GU10



2x 3W



warm  
WHITE  
2x  
250lm



9 002759 953737

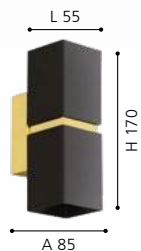





98379



98755

### 98379 GASCUERIA

wall light; plastic, steel, gold, black  
Wandleuchte; Kunststoff, Stahl, gold, schwarz  
applique; plastique, acier, or, noir

L 290, H 330, A 130



E27 1x 60W



9 002759 983796



### 98755 ELIZONDO

wall light; steel, black, gold  
Wandleuchte; Stahl, schwarz, gold  
applique; acier, noir, or

L 80, H 270, A 115



E14 1x 40W



9 002759 987558



### 98759 FALICETTO

wall light; steel, black, gold  
Wandleuchte; Stahl, schwarz, gold  
applique; acier, noir, or

L 160, H 250, A 115



E27 1x 40W



9 002759 987596





98759





98656



98655



98657



### 98656 MONGODIO 1

wall / ceiling light; steel, white / plastic, white  
Wand- / Deckenleuchte; Stahl, weiss / Kunststoff, weiss  
applique / plafonnier; acier, blanc / plastique, blanc

H 35, Ø 200



8,6W 920lm



9 002759 986568



Ø 200

### 98655 MONGODIO 1

wall / ceiling light; steel, white / plastic, white  
Wand- / Deckenleuchte; Stahl, weiss / Kunststoff, weiss  
applique / plafonnier; acier, blanc / plastique, blanc

H 35, Ø 140



5,4W 570lm



9 002759 986551



Ø 140

### 98657 MONGODIO 1

wall / ceiling light; steel, white / plastic, white  
Wand- / Deckenleuchte; Stahl, weiss / Kunststoff, weiss  
applique / plafonnier; acier, blanc / plastique, blanc

H 35, Ø 250



11,4W 1240lm



9 002759 986575



Ø 250



98676

LED



### 98676 ELGVERO

wall / ceiling light; steel, white / plastic, white  
 Wand- / Deckenleuchte; Stahl, weiss / Kunststoff, weiss  
 applique / plafonnier; acier, blanc / plastique, blanc

H 100, Ø 250

LED	warm WHITE	LED	warm WHITE	LED
5,4W	570lm	8,6W	920lm	11.4W

warm WHITE		
1240lm		



Ø 250

### 98676

By turning you can adjust the luminaire individually.

Durch drehen kann man die Leuchte individuell einstellen.

En tournant, vous pouvez régler la lampe individuellement.





30658

LED



30659

LED



33941

LED



### 30658 CADEGAL

ceiling light; steel, black / plastic, white  
Deckenleuchte; Stahl, schwarz / Kunststoff, weiss  
plafonnier; acier, noir / plastique, blanc

L 200, B 200, H 50

LED

neutral  
WHITE  
9W 1214lm



### 30659 CADEGAL

ceiling light; steel, black / plastic, white  
Deckenleuchte; Stahl, schwarz / Kunststoff, weiss  
plafonnier; acier, noir / plastique, blanc

H 50, Ø 200

LED

neutral  
WHITE  
9W 1192lm



### 33941 CADEGAL

ceiling light; steel, white / plastic, white  
Deckenleuchte; Stahl, weiss / Kunststoff, weiss  
plafonnier; acier, blanc / plastique, blanc

L 200, B 200, H 50

LED

neutral  
WHITE  
9W 1214lm



9 002759 306588

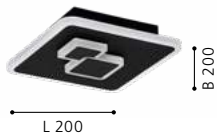

9 002759 306595



9 002759 339418

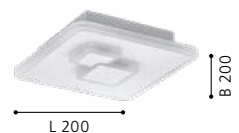





33942

LED



33964

LED

### 33942 CADEGAL

ceiling light; steel, white / plastic, white  
Deckenleuchte; Stahl, weiss / Kunststoff, weiss  
plafonnier; acier, blanc / plastique, blanc

H 50, Ø 200



9W 1192lm



Ø 200

### 33964 REMIDOS

ceiling light; steel, white / plastic, white  
Deckenleuchte; Stahl, weiss / Kunststoff, weiss  
plafonnier; acier, blanc / plastique, blanc

H 90, Ø 400



15W 2250lm 4W 650lm



Ø 400



98888

LED



96038

LED



96037

LED

### 98888 METRASS

wall light; aluminium, black / plastic, satined  
Wandleuchte; Alu, schwarz / Kunststoff, satiniert  
applique; aluminium, noir / plastique, satiné

L 200, H 105, A 60



1x 5,6W  
1x 680lm



9 002759 988883



### 96037 METRASS

wall light; aluminium, white / plastic, satined  
Wandleuchte; Alu, weiss / Kunststoff, satiniert  
applique; aluminium, blanc / plastique, satiné

L 200, H 105, A 60



1x 5,6W  
1x 680lm



9 002759 960377



### 96038 METRASS

wall light; aluminium, satin nickel / plastic, satined  
Wandleuchte; Alu, nickel-matt / Kunststoff, satiniert  
applique; aluminium, nickel mat / plastique, satiné

L 200, H 105, A 60



1x 5,6W  
1x 680lm



9 002759 960384





96042



96043



### 96042 METRASS 2

wall / ceiling light; aluminium, white / plastic, satined  
 Wand- / Deckenleuchte; Alu, weiss / Kunststoff, satiniert  
 applique / plafonnier; aluminium, blanc / plastique, satiné

L 170, H 200, A 55



### 96043 METRASS 2

wall / ceiling light; aluminium, satin nickel / plastic, satined  
 Wand- / Deckenleuchte; Alu, nickel-matt / Kunststoff, satiniert  
 applique / plafonnier; aluminium, nickel mat / plastique, satiné

L 170, H 200, A 55





96039

LED



96041

LED

### 96039 METRASS 1

wall light; aluminium, white / plastic, satined  
Wandleuchte; Alu, weiss / Kunststoff, satiniert  
applique; aluminium, blanc / plastique, satiné

L 130, H 130, A 50

LED

1x 4,5W

warm  
WHITE

1x  
480lm



9 002759 960391

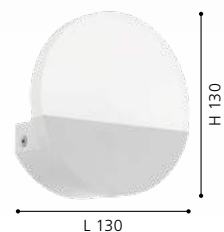



96002



95774



### 96041 METRASS 1

wall light; aluminium, satin nickel / plastic, satiné  
Wandleuchte; Alu, nickel-matt / Kunststoff, satiniert  
applique; aluminium, nickel mat / plastique, satiné

L 130, H 130, A 50



1x 4,5W  
1x 480lm



9 002759 960414



### 96002 PEDRISTELLA

wall / ceiling light; steel, satin nickel / satin glass, white  
Wand- / Deckenleuchte; Stahl, nickel-matt / Glas satiniert, weiss  
applique / plafonnier; acier, nickel mat / verre satiné, blanc

H 80, Ø 130



6W  
500lm



9 002759 960025



### 95774 CUPELLA

wall light; steel, satin nickel / plastic, white  
Wandleuchte; Stahl, nickel-matt / Kunststoff, weiss  
applique; acier, nickel mat / plastique, blanc

L 110, H 180, A 65



2x 4,5W  
2x 480lm



9 002759 957742







95768



99606



99607



### 95768 LASANA

wall light; steel, aluminium, chrome / plastic, white  
Wandleuchte; Stahl, Alu, chrom / Kunststoff, weiss  
applique; acier, aluminium, chrome / plastique, blanc

L 180, H 195, A 60



5,5W 550lm



9 002759 957681



### 99606 SARGINTO

wall / ceiling light; steel, white / plastic, white  
Wand- / Deckenleuchte; Stahl, weiss / Kunststoff, weiss  
applique / plafonnier; acier, blanc / plastique, blanc

L 590, B 140, H 45



6,3W 690lm 5,4W



9 002759 996062



### 99607 SARGINTO

wall / ceiling light; steel, white / plastic, white  
Wand- / Deckenleuchte; Stahl, weiss / Kunststoff, weiss  
applique / plafonnier; acier, blanc / plastique, blanc

L 590, B 130, H 45



6,3W 690lm 5,4W



9 002759 996079





99609



99608



### 99609 SARGINTO

wall / ceiling light; steel, black / plastic, white  
 Wand- / Deckenleuchte; Stahl, schwarz / Kunststoff, weiss  
 applique / plafonnier; acier, noir / plastique, blanc

L 590, B 130, H 45



6,3W 690lm 5,4W



9 002759 996093



### 99608 SARGINTO

wall / ceiling light; steel, black / plastic, white  
 Wand- / Deckenleuchte; Stahl, schwarz / Kunststoff, weiss  
 applique / plafonnier; acier, noir / plastique, blanc

L 590, B 140, H 45



6,3W 690lm 5,4W



9 002759 996086

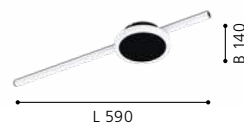

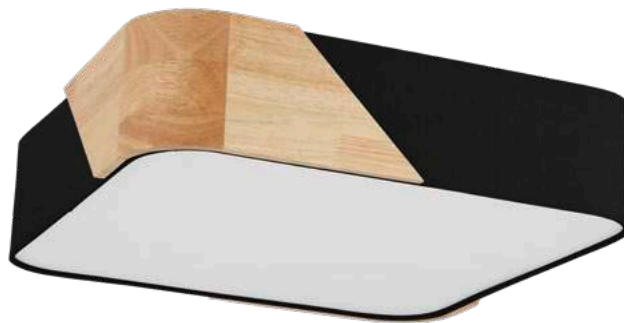

99389



99388



99458

### 99388 GRIMALDINO

ceiling light; fabric, wood, steel, black, brown / plastic, white  
 Deckenleuchte; Textil, Holz, Stahl, schwarz, braun / Kunststoff, weiss  
 plafonnier; tissu, bois, acier, noir, marron / plastique, blanc

H 125, Ø 400



E27 2x 28W



9 002759 993887

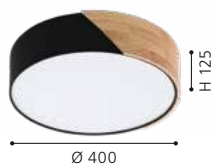

### 99389 GRIMALDINO

ceiling light; fabric, wood, steel, black, brown / plastic, white  
 Deckenleuchte; Textil, Holz, Stahl, schwarz, braun / Kunststoff, weiss  
 plafonnier; tissu, bois, acier, noir, marron / plastique, blanc

L 415, B 415, H 125



E27 2x 28W



9 002759 993894

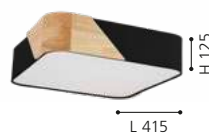

### 99458 GRIMALDINO

ceiling light; fabric, wood, steel, white, brown / plastic, white  
 Deckenleuchte; Textil, Holz, Stahl, weiss, braun / Kunststoff, weiss  
 plafonnier; tissu, bois, acier, blanc, marron / plastique, blanc

H 125, Ø 400



E27 2x 28W



9 002759 994587

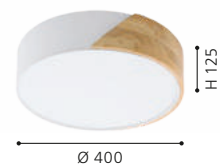



### 99459 GRIMALDINO

ceiling light; fabric, wood, steel, white, brown / plastic, white  
 Deckenleuchte; Textil, Holz, Stahl, weiss, braun / Kunststoff, weiss  
 plafonnier; tissu, bois, acier, blanc, marron / plastique, blanc

L 415, B 415, H 125

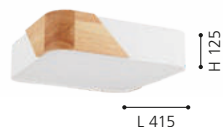

### 99461 GRIMALDINO

ceiling light; fabric, wood, steel, taupe, brown / plastic, white  
 Deckenleuchte; Textil, Holz, Stahl, taupe, braun / Kunststoff, weiss  
 plafonnier; tissu, bois, acier, taupe, marron / plastique, blanc

H 125, Ø 400

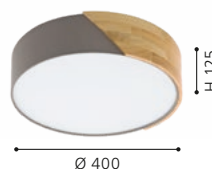

### 99462 GRIMALDINO

ceiling light; fabric, wood, steel, taupe, brown / plastic, white  
 Deckenleuchte; Textil, Holz, Stahl, taupe, braun / Kunststoff, weiss  
 plafonnier; tissu, bois, acier, taupe, marron / plastique, blanc

L 415, B 415, H 125

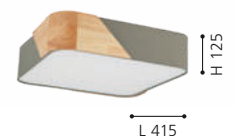

# BATH & MIRROR LUMINAIRES

BAD- & SPIEGELLEUCHTEN  
LUMINAIRES DE BAIN & MIROIR

## PURE RELAXATION -

Turn your bathroom into your personal wellness oasis. Trendy bathroom and mirror luminaires give a pleasant light and ensure relaxation and comfort.

## ENTSPANNUNG PUR -

Verwandeln Sie Ihr Badezimmer in eine persönliche Wohlfühloase. Trendige Bad- und Spiegelleuchten spenden ein angenehmes Licht und sorgen für Entspannung und Ihr Wohlbefinden.



## DE LA PURE DÉTENTE -









































Transformez votre salle de bains en un îlot personnel de bien-être. Des éclairages à la mode de miroirs et de bain confèrent une lumière agréable et vous assurent de la détente et du bien-être.





# OVERVIEW

## BATH & MIRROR LUMINAIRES

 AMEZOLA p. 558	 TAMARA 1 p. 560-561	 ALMONTE p. 562	 TOLORICO p. 564	 MOSIANO p. 566	 PALMITAL p. 566	 WASAO 1 p. 568-569	 BARI-M p. 570
 FRANIA p. 570-571	 MANILVA 1 p. 571	 LED PALERMO p. 573	 LED LORA p. 573	 LED CARPI p. 574-575	 FUEVA 5 p. 576-578	 ROMENDO 1 p. 580-581	 CABUS p. 582
 SIDERNO p. 584	 SANIA 5 p. 584-585	 TRAGACETE 1 p. 586-587	 GITA 2 p. 588	 CALNOVA p. 590	 TORRETTA p. 591	 TABIANO p. 593	 VADUMI p. 594
 PANDELLA 1 p. 596-599	 PANDELLA 2 p. 596, 600	 VINCHIO p. 600	 PALMERA p. 602	 CAILIN p. 602	 STICKER p. 603	 ZOLA p. 604	 MONO p. 604-605
 BARI 1 p. 605	 FUEVA 5 p. 606-611	 BUENAVISTA p. 612	 BUENAVISTA 1 p. 614	 BUENAVISTA 2 p. 614-615			
 TABIANO-Z p. 29	 JUAREZA-Z p. 29	 FUEVA-Z p. 48-59					

You can also find bathroom and mirror lights in EGLO connect.Z.  
 Bad und Spiegelleuchten finden sie auch in EGLO connect.Z.  
 Vous pouvez également trouver des lampes de salle de bain et de miroir dans EGLO connect.Z.



This product is available in different colors and shapes./ Dieser Artikel ist in unterschiedlichen Farben und Formen verfügbar.  
 Cet article est disponible en différentes couleurs et formes.

# COLOUR RENDERING INDEX

FARBWIEDERGABE-INDEX

L'INDICE DE RESTITUTION DE COULEURS

**QUALITY CRITERION COLOUR RENDERING** The colour rendering index Ra describes the colour rendering quality of lamps. The higher the Ra value, the less will the artificial light change the colour of an object. The maximum Ra value (e.g. the Ra value of the sun) is 100.

Therefore, lamps with an Ra above 90 will make you look better.

Lamps with an Ra value above 90 are marked with this button: 



**QUALITÄTSKRITERIUM FARBWIEDERGABE** Mit dem Farbwiedergabe-Index Ra wird die Qualität der Farbwiedergabe von Leuchten beschrieben. Je höher der Ra-Wert ist, desto weniger verfälscht das künstliche Licht die Farbe von Objekten. Der maximale Ra-Wert (z.B. der Ra-Wert der Sonne) ist 100.

Leuchten mit Ra >90 lassen Sie somit besser aussehen.

Leuchten die einen Ra-Wert von >90 haben, sind mit diesem Button gekennzeichnet: 



**CRITÈRE DE QUALITÉ INDIQUANT LA RESTITUTION DES COULEURS** L'indice de restitution de couleurs Ra décrit la qualité de restitution des éclairages. Plus la valeur Ra est élevée, moins la lumière artificielle falsifie la couleur des objets. La valeur Ra maximale (par ex. la valeur Ra du soleil) est 100.

Ainsi, favorisez des lampes avec une valeur Ra > 90.

Les lampes ayant une valeur Ra > 90 sont identifiées par ce bouton: 



99122



99122 | 99123 | 99124



99124

### 99122 AMEZOLA

wall / ceiling light; steel, black / glass, clear  
Wand- / Deckenleuchte; Stahl, schwarz / Glas, klar  
applique / plafonnier; acier, noir / verre, clair

L 290, H 290, A 130



E27

2x 40W

IP44



9 002759 991227



L 290

### 99124 AMEZOLA

wall light; steel, black / glass, clear  
Wandleuchte; Stahl, schwarz / Glas, klar  
applique; acier, noir / verre, clair

L 110, H 380, A 100



E27

2x 60W

IP44



9 002759 991241



A 100

### 99123 AMEZOLA

wall light; steel, black / glass, clear  
Wandleuchte; Stahl, schwarz / Glas, klar  
applique; acier, noir / verre, clair

L 110, H 260, A 100



E27

1x 60W

IP44



9 002759 991234



A 100



**99123**







95994

LED



95993

LED



95995

LED

### 95993 TAMARA 1

spot; steel, glass, white, chrome  
Spot; Stahl, Glas, weiss, chrom  
spot; acier, verre, blanc, chrome

L 120, B 120

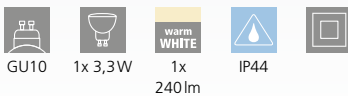

L 120

### 95994 TAMARA 1

spot; steel, glass, white, chrome  
Spot; Stahl, Glas, weiss, chrom  
spot; acier, verre, blanc, chrome

L 460, B 70

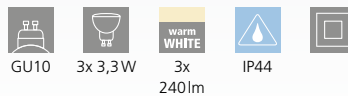

L 460

### 95995 TAMARA 1

spot; steel, glass, white, chrome  
Spot; Stahl, Glas, weiss, chrom  
spot; acier, verre, blanc, chrome

L 240, B 260

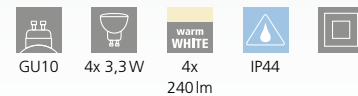

L 240

B 260



33678

LED

DESIGN  
HIGHLIGHT  
DETAIL



33677

LED



### 33677 TAMARA 1

spot; steel, black, chrome / glass, clear  
Spot; Stahl, schwarz, chrom / Glas, klar  
spot; acier, noir, chrome / verre, clair

L 120, B 120

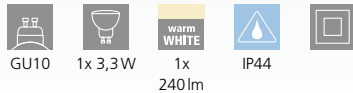

GU10 1x 3,3W 1x warm WHITE IP44



L 120

### 33678 TAMARA 1

spot; steel, black, chrome / glass, clear  
Spot; Stahl, schwarz, chrom / Glas, klar  
spot; acier, noir, chrome / verre, clair

L 240, B 260

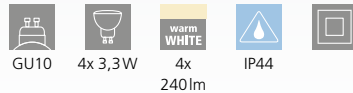

GU10 4x 3,3W 4x warm WHITE IP44



L 240

B 260

DESIGN  
HIGHLIGHT  
DETAIL



94879

LED



97699

LED

### 94879 ALMONTE

wall light; steel, chrome / crystal, clear  
Wandleuchte; Stahl, chrom / Kristall, klar  
applique; acier, chrome / cristal, clair

L 110, H 230, A 170



9 002759 948795



### 97699 ALMONTE

ceiling light; steel, chrome / crystal, clear  
Deckenleuchte; Stahl, chrom / Kristall, klar  
plafonnier; acier, chrome / cristal, clair

H 300, Ø 500



9 002759 976996

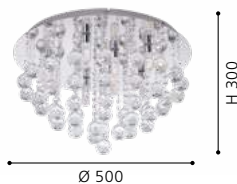

### 94878 ALMONTE

ceiling light; steel, chrome / crystal, clear  
Deckenleuchte; Stahl, chrom / Kristall, klar  
plafonnier; acier, chrome / cristal, clair

H 230, Ø 350



9 002759 948788







94878

LED





## TOLORICO

These luminaires come with high quality glass crystals.

Diese Leuchten sind mit hochwertigen Glaskristallen ausgestattet.

Ces luminaires viennent avec des cristaux de verre de haute qualité.



97055

LED

97054

LED

### 97054 TOLORICO

wall / ceiling light; stainless steel, chrome / plastic, crystal, clear  
Wand- / Deckenleuchte; Edelstahl, chrom / Kunststoff, Kristall, klar

applique / plafonnier; acier inoxydable, chrome / plastique, cristal, clair

L 350, B 100, H 70



8W



1100lm



IP44



### 97055 TOLORICO

wall / ceiling light; stainless steel, chrome / plastic, crystal, clear  
Wand- / Deckenleuchte; Edelstahl, chrom / Kunststoff, Kristall, klar

applique / plafonnier; acier inoxydable, chrome / plastique, cristal, clair

L 570, B 100, H 75



19W



2500lm



IP44



### 97056 TOLORICO

wall / ceiling light; stainless steel, chrome / plastic, crystal, clear  
Wand- / Deckenleuchte; Edelstahl, chrom / Kunststoff, Kristall, klar

applique / plafonnier; acier inoxydable, chrome / plastique, cristal, clair

L 350, B 350, H 75



3x 7W



3x  
1000lm



IP44



9 002759 970543



L 350



9 002759 970550



L 570



9 002759 970567



L 350





97056

LED



94626

LED



97966

LED

### 94626 MOSIANO

wall / ceiling light; stainless steel, chrome / glass opal-matt, white  
Wand- / Deckenleuchte; Edelstahl, chrom / Glas opal-matt, weiss  
applique / plafonnier; acier inoxydable, chrome / verre opale mat, blanc

H 115, Ø 110



1x 3,3W  
1x  
340lm

### 97966 PALMITAL

wall light; aluminium, steel, chrome / plastic, clear  
Wandleuchte; Alu, Stahl, chrom / Kunststoff, klar  
applique; aluminium, acier, chrome / plastique, clair

L 595, H 80, A 65



1x 10W  
1x  
1300lm

### 97965 PALMITAL

wall / ceiling light; aluminium, steel, chrome / plastic, clear  
Wand- / Deckenleuchte; Alu, Stahl, chrom / Kunststoff, klar  
applique / plafonnier; aluminium, acier, chrome / plastique, clair

L 880, B 100, H 90



2x 10W  
2x  
1300lm



9 002759 946265



9 002759 979669



9 002759 979652

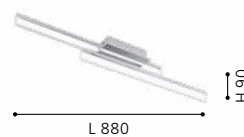



97965

LED





94882

LED



94881

LED



94884

LED

### 94881 WASAO 1

wall / ceiling light; stainless steel, chrome / glass painted, white  
Wand- / Deckenleuchte; Edelstahl, chrom / Glas lackiert, weiss  
applique / plafonnier; acier inoxydable, chrome / verre laqué, blanc

L 210, B 105, A 60



1x 5,4W

510lm

IP44

### 94882 WASAO 1

wall / ceiling light; stainless steel, chrome / glass painted, white  
Wand- / Deckenleuchte; Edelstahl, chrom / Glas lackiert, weiss  
applique / plafonnier; acier inoxydable, chrome / verre laqué, blanc

L 420, B 105, H 60



2x 5,4W

2x  
510lm

IP44

### 94884 WASAO 1

wall / ceiling light; stainless steel, chrome / glass painted, white  
Wand- / Deckenleuchte; Edelstahl, chrom / Glas lackiert, weiss  
applique / plafonnier; acier inoxydable, chrome / verre laqué, blanc

L 320, B 320, H 60



4x 5,4W

4x  
510lm

IP44



9 002759 948818



9 002759 948825



9 002759 948849





### 94883 WASAO 1

wall / ceiling light; stainless steel, chrome / glass painted, white  
Wand- / Deckenleuchte; Edelstahl, chrom / Glas lackiert, weiss  
applique / plafonnier; acier inoxydable, chrome / verre laqué,  
blanc

L 630, B 105, H 60



9 002759 948832



94883







97531



97531



97884

LED

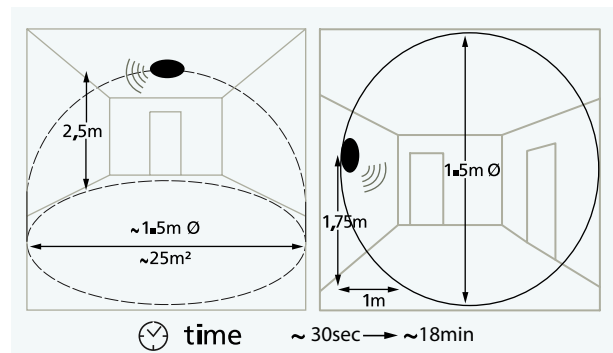

97531

This luminaire comes with an integrated motion sensor.  
The sensor is mounted invisibly behind the glass.

Diese Leuchte ist mit einem integrierten Bewegungssensor ausgestattet.  
Der Sensor ist unsichtbar hinter dem Glas befestigt.

Ce luminaire vient avec un capteur de mouvement intégré.  
Le capteur est attaché invisiblement derrière le verre.

### 97531 BARI-M

ceiling light; plastic, white / glass, white  
Deckenleuchte; Kunststoff, weiss / Glas, weiss  
plafonnier; plastique, blanc / verre, blanc

H 110, Ø 275



E27



1x 20W



IP44



### 97884 FRANIA

wall / ceiling light; steel, white / plastic, white  
Wand- / Deckenleuchte; Stahl, weiss / Kunststoff, weiss  
applique / plafonnier; acier, blanc / plastique, blanc

H 70, Ø 330



17,3W



2000lm



IP44



9 002759 975319



Ø 275



9 002759 978846



Ø 330



96231

LED



96229

LED



97885

LED



### 97885 FRANIA

wall / ceiling light; steel, white / plastic, white  
Wand- / Deckenleuchte; Stahl, weiss / Kunststoff, weiss  
applique / plafonnier; acier, blanc / plastique, blanc

L 330, B 330, H 70

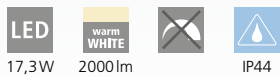

17,3W 2000lm

### 96231 MANILVA 1

wall light; steel, satin nickel / plastic, white  
Wandleuchte; Stahl, nickel-matt / Kunststoff, weiss  
applique; acier, nickel mat / plastique, blanc

L 290, B 290, H 70



16W 1500lm

### 96229 MANILVA 1

wall light; steel, chrome / plastic, white  
Wandleuchte; Stahl, chrom / Kunststoff, weiss  
applique; acier, chrome / plastique, blanc

L 290, B 290, H 70



16W 1500lm



9 002759 978853



L 330



9 002759 962319



L 290



9 002759 962296



L 290



94999

LED



94998

LED



95001

LED

### 94999 LED PALERMO

wall / ceiling light; steel, chrome / satin glass, white painted  
Wand- / Deckenleuchte; Stahl, chrom / Glas satiniert, weiss lackiert  
applique / plafonnier; acier, chrome / verre satiné, blanc laqué

Ø 295, A 77



24W 2100lm

### 94998 LED PALERMO

wall / ceiling light; steel, chrome / satin glass, white painted  
Wand- / Deckenleuchte; Stahl, chrom / Glas satiniert, weiss lackiert  
applique / plafonnier; acier, chrome / verre satiné, blanc laqué

Ø 225, A 60



11W 950lm

### 95001 LED LORA

ceiling light; steel, chrome / glass opal-matt, white  
Deckenleuchte; Stahl, chrom / Glas opal-matt, weiss  
plafonnier; acier, chrome / verre opale mat, blanc

Ø 320, A 70



16W 1500lm



9 002759 949990



Ø 295



9 002759 949983



Ø 225



9 002759 950019



Ø 320



33682



94967



95282



### 33682 LED CARPI

wall / ceiling light; steel, black, white / plastic, white  
Wand- / Deckenleuchte; Stahl, schwarz, weiss / Kunststoff, weiss  
applique / plafonnier; acier, noir, blanc / plastique, blanc

Ø 300, A 75



### 95282 LED CARPI

wall / ceiling light; steel, white, chrome / plastic, white  
Wand- / Deckenleuchte; Stahl, weiss, chrom / Kunststoff, weiss  
applique / plafonnier; acier, blanc, chrome / plastique, blanc

Ø 300, A 75



### 94967 LED CARPI

wall / ceiling light; steel, aluminium, white, brushed aluminium / plastic, white  
Wand- / Deckenleuchte; Stahl, Alu, weiss, alu-gebürstet / Kunststoff, weiss  
applique / plafonnier; acier, aluminium, blanc, aluminium brossé / plastique, blanc  
Ø 300, A 75



9 002759 336820



Ø 300



9 002759 952822



Ø 300



9 002759 949679



Ø 300





95283

LED

### 95283 LED CARPI

wall / ceiling light; steel, white, chrome / plastic, white  
Wand- / Deckenleuchte; Stahl, weiss, chrom / Kunststoff, weiss  
applique / plafonnier; acier, blanc, chrome / plastique, blanc

Ø 385, A 75

LED

16W

warm  
WHITE

1500lm



IP44



9 002759 952839



Ø 385





99265



99267



### 99265 FUEVA 5

surface-mounted light; steel, white / plastic, white  
Aufbauleuchte; Stahl, weiss / Kunststoff, weiss  
luminaire en saillie; acier, blanc / plastique, blanc

H 28, Ø 285



Ø 285

### 99267 FUEVA 5

surface-mounted light; steel, black / plastic, white  
Aufbauleuchte; Stahl, schwarz / Kunststoff, weiss  
luminaire en saillie; acier, noir / plastique, blanc

H 28, Ø 285



Ø 285

### 99266 FUEVA 5

surface-mounted light; steel, chrome / plastic, white  
Aufbauleuchte; Stahl, chrom / Kunststoff, weiss  
luminaire en saillie; acier, chrome / plastique, blanc

H 28, Ø 285



Ø 285



99266

LED





99268



99271



### 99268 FUEVA 5

surface-mounted light; steel, white / plastic, white  
 Aufbauleuchte; Stahl, weiss / Kunststoff, weiss  
 luminaire en saillie; acier, blanc / plastique, blanc

L 285, B 285, H 30



### 99271 FUEVA 5

surface-mounted light; steel, black / plastic, white  
 Aufbauleuchte; Stahl, schwarz / Kunststoff, weiss  
 luminaire en saillie; acier, noir / plastique, blanc

L 285, B 285, H 30



### 99269 FUEVA 5

surface-mounted light; steel, chrome / plastic, white  
 Aufbauleuchte; Stahl, chrom / Kunststoff, weiss  
 luminaire en saillie; acier, chrome / plastique, blanc

L 285, B 285, H 30



9 002759 992682



9 002759 992712

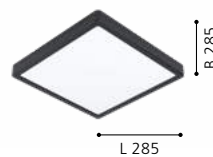

9 002759 992699





99269

LED







**96541 ROMENDO 1**

wall light; steel, chrome / plastic, clear, satiné  
Wandleuchte; Stahl, chrom / Kunststoff, klar, satiniert  
applique; acier, chrome / plastique, clair, satiné

L 70, H 155, A 120

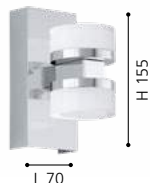
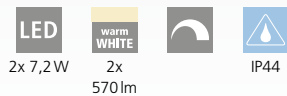

**96542 ROMENDO 1**

wall light; steel, chrome / plastic, clear, satiné  
Wandleuchte; Stahl, chrom / Kunststoff, klar, satiniert  
applique; acier, chrome / plastique, clair, satiné

L 300, H 70, A 125

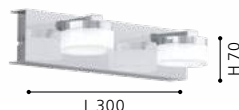
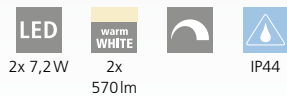

**96544 ROMENDO 1**

ceiling light; steel, chrome / plastic, clear, satiné  
Deckenleuchte; Stahl, chrom / Kunststoff, klar, satiniert  
plafonnier; acier, chrome / plastique, clair, satiné

L 320, B 320, H 70





### ROMENDO 1

These luminaires are dimmable.

Diese Leuchten sind dimmbar.

Ces luminaires sont graduables.

### 96543 ROMENDO 1

wall light; steel, chrome / plastic, clear, satined  
Wandleuchte; Stahl, chrom / Kunststoff, klar, satiniert  
applique; acier, chrome / plastique, clair, satiné

L 450, H 70, A 125



3x 7,2W



3x  
570lm



IP44



9 002759 965433



96543

LED





96937



96938



### 96937 CABUS

wall light; steel, chrome / plastic, satined  
Wandleuchte; Stahl, chrom / Kunststoff, satiniert  
applique; acier, chrome / plastique, satiné

L 450, H 45, A 115



3x 4,5W  
3x  
420lm

### 96938 CABUS

wall light; steel, chrome / plastic, satined  
Wandleuchte; Stahl, chrom / Kunststoff, satiniert  
applique; acier, chrome / plastique, satiné

L 580, H 45, A 115



4x 4,5W  
4x  
420lm

### 96939 CABUS

ceiling light; steel, chrome / plastic, satined  
Deckenleuchte; Stahl, chrom / Kunststoff, satiniert  
plafonnier; acier, chrome / plastique, satiné

L 350, B 350, H 45



5x 4,5W  
5x  
420lm



9 002759 969370

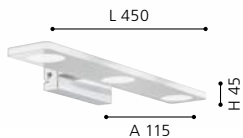

9 002759 969387

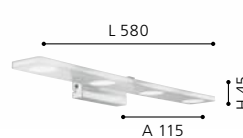

9 002759 969394

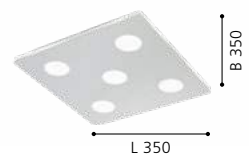



96939

LED





99692

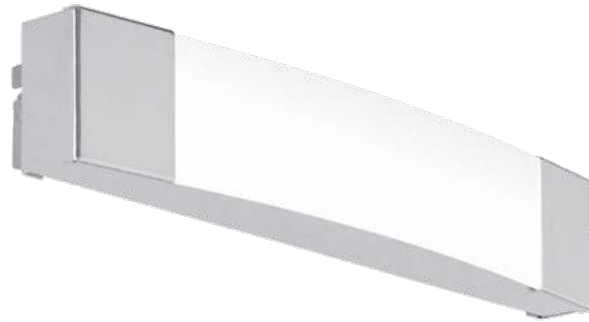

97718

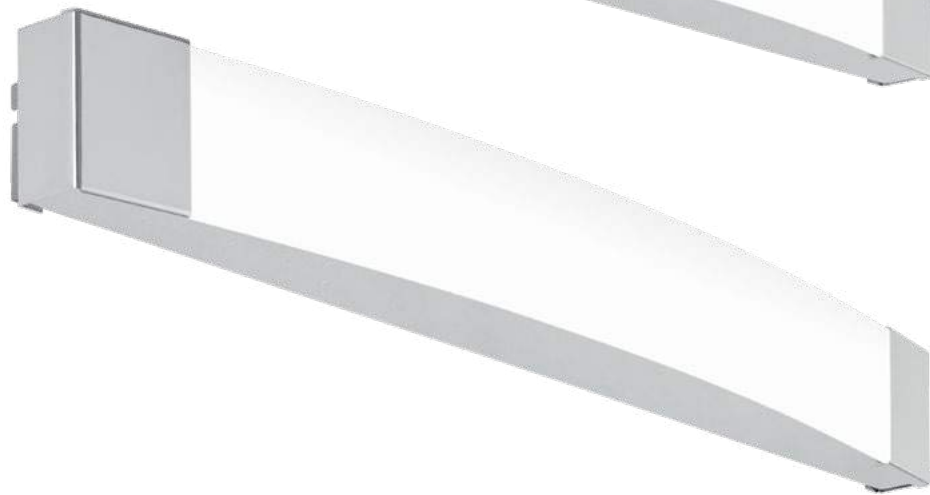

97719



### 97718 SIDERNO

mirror light; steel, chrome / plastic, satiné  
Spiegelleuchte; Stahl, chrom / Kunststoff, satiniert  
applique pour miroir; acier, chrome / plastique, satiné

L 350, B 60, A 55



8,3W 900lm

### 97719 SIDERNO

mirror light; steel, chrome / plastic, satiné  
Spiegelleuchte; Stahl, chrom / Kunststoff, satiniert  
applique pour miroir; acier, chrome / plastique, satiné

L 580, B 60, A 65



16W 1700lm

### 99692 SANIA 5

wall light; steel, satin nickel, white / plastic, satiné  
Wandleuchte; Stahl, nickel-matt, weiss / Kunststoff, satiniert  
applique; acier, nickel mat, blanc / plastique, satiné

L 620, H 80, A 90



26,5W 2700lm



9 002759 977184

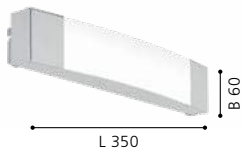

L 350



9 002759 977191

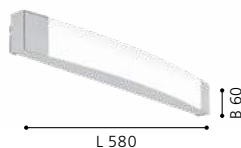

L 580



9 002759 996925

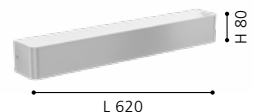

L 620





99691

LED

### 99691 SANIA 5

wall light; steel, black, white / plastic, satined  
Wandleuchte; Stahl, schwarz, weiss / Kunststoff, satiniert  
applique; acier, noir, blanc / plastique, satiné

L 620, H 80, A 90

LED

26,5W

warm  
WHITE

2700lm



IP44



9 002759 996918

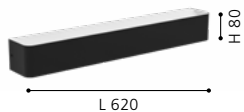



## TRAGACETE 1

These luminaires refer to an on / off button directly on the luminaire.

Diese Leuchten verfügen über einen Ein-/Ausschaltknopf direkt an der Leuchte.

Ces luminaires se réfèrent à un bouton marche / arrêt directement sur le luminaire.



99776



99777



99778



### 99776 TRAGACETE 1

mirror light; plastic, steel, silver, chrome / plastic, white  
Spiegelleuchte; Kunststoff, Stahl, silber, chrom / Kunststoff, weiss  
applique pour miroir; plastique, acier, argent, chrome / plastique, blanc

L 450, B 45, H 45



7,5W



900lm



IP44



9 002759 997762



### 99777 TRAGACETE 1

mirror light; plastic, steel, silver, chrome / plastic, white  
Spiegelleuchte; Kunststoff, Stahl, silber, chrom / Kunststoff, weiss  
applique pour miroir; plastique, acier, argent, chrome / plastique, blanc

L 600, B 45, H 45



15,5W



1900lm



IP44



9 002759 997779



### 99778 TRAGACETE 1

mirror light; plastic, steel, silver, chrome / plastic, white  
Spiegelleuchte; Kunststoff, Stahl, silber, chrom / Kunststoff, weiss  
applique pour miroir; plastique, acier, argent, chrome / plastique, blanc

L 770, B 45, H 45



18,5W



2600lm



IP44



9 002759 997786





99339

LED

### 99339 TRAGACETE 1

mirror light; aluminium, silver, chrome / plastic, white  
 Spiegelleuchte; Alu, silber, chrom / Kunststoff, weiss  
 applique pour miroir; aluminium, argent, chrome / plastique, blanc

L 680, B 55, H 70

LED

15W

neutral  
WHITE

1600lm



IP44

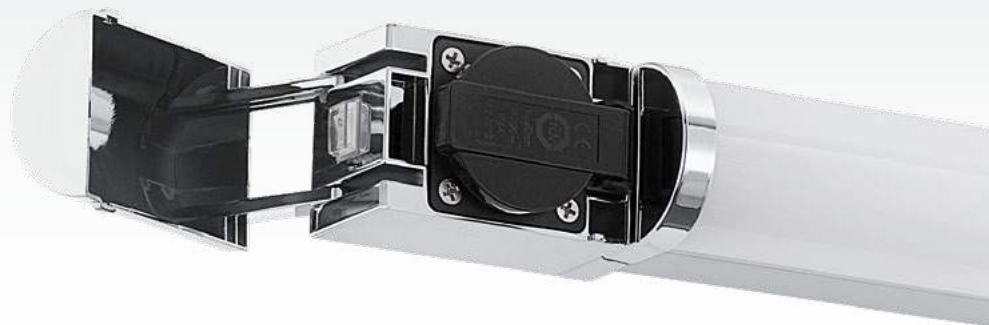

9 002759 993399



### 99339

This luminaire has a built-in socket.

Diese Leuchte verfügt über eine eingebaute Steckdose.

Cette luminaire a une douille intégrée.



DESIGN  
HIGHLIGHT  
DETAIL



94712



94713



### 94712 GITA 2

wall / ceiling light; cast metal, chrome / plastic, white  
Wand- / Deckenleuchte; Metallguss, chrom / Kunststoff, weiss  
applique / plafonnier; fonte métallique, chrome / plastique,  
blanc

L 350, B 75, H 75



8,3W



900lm



IP44



### 94713 GITA 2

wall / ceiling light; cast metal, chrome / plastic, white  
Wand- / Deckenleuchte; Metallguss, chrom / Kunststoff, weiss  
applique / plafonnier; fonte métallique, chrome / plastique,  
blanc

L 600, B 75, H 75



16W



1700lm



IP44



### 94714 GITA 2

wall / ceiling light; cast metal, chrome / plastic, white  
Wand- / Deckenleuchte; Metallguss, chrom / Kunststoff, weiss  
applique / plafonnier; fonte métallique, chrome / plastique,  
blanc

L 900, B 75, H 75



24,3W



2600lm



IP44



9 002759 947125



9 002759 947132



9 002759 947149

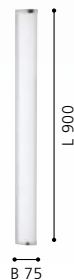



94714

LED





DESIGN  
HIGHLIGHT  
DETAIL



94715



94716



94717



### 94715 CALNOVA

wall light; steel, satin nickel / satin glass, white  
Wandleuchte; Stahl, nickel-matt / Glas satiniert, weiss  
applique; acier, nickel mat / verre satiné, blanc

L 350, B 50, A 85



9 002759 947156

CRI  
>90



### 94716 CALNOVA

wall light; steel, satin nickel / satin glass, white  
Wandleuchte; Stahl, nickel-matt / Glas satiniert, weiss  
applique; acier, nickel mat / verre satiné, blanc

L 600, B 50, A 85



9 002759 947163

CRI  
>90

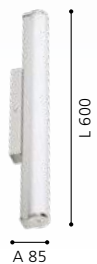

### 94717 CALNOVA

wall light; steel, satin nickel / satin glass, white  
Wandleuchte; Stahl, nickel-matt / Glas satiniert, weiss  
applique; acier, nickel mat / verre satiné, blanc

L 900, B 50, A 85



9 002759 947170

CRI  
>90





DESIGN  
HIGHLIGHT  
DETAIL



94616

LED



94617

LED



94618

LED

### 94616 TORRETTA

mirror light; steel, satin nickel / plastic, white  
Spiegelleuchte; Stahl, nickel-matt / Kunststoff, weiss  
applique pour miroir; acier, nickel mat / plastique, blanc

L 350, B 40, A 75



CRI >90



### 94617 TORRETTA

mirror light; steel, satin nickel / plastic, white  
Spiegelleuchte; Stahl, nickel-matt / Kunststoff, weiss  
applique pour miroir; acier, nickel mat / plastique, blanc

L 600, B 40, A 75



CRI >90



### 94618 TORRETTA

mirror light; steel, satin nickel / plastic, white  
Spiegelleuchte; Stahl, nickel-matt / Kunststoff, weiss  
applique pour miroir; acier, nickel mat / plastique, blanc

L 900, B 40, A 75



CRI >90





94613

LED





94614



94612



### 94613 TABIANO

mirror light; steel, chrome / plastic, white  
Spiegelleuchte; Stahl, chrom / Kunststoff, weiss  
applique pour miroir; acier, chrome / plastique, blanc

L 605, H 70, A 130



3x 3,2W 900lm

### 94614 TABIANO

mirror light; steel, satin nickel / plastic, white  
Spiegelleuchte; Stahl, nickel-matt / Kunststoff, weiss  
applique pour miroir; acier, nickel mat / plastique, blanc

L 405, H 70, A 130



2x 3,2W 600lm

### 94612 TABIANO

mirror light; steel, chrome / plastic, white  
Spiegelleuchte; Stahl, chrom / Kunststoff, weiss  
applique pour miroir; acier, chrome / plastique, blanc

L 405, H 70, A 130



2x 3,2W 600lm



9 002759 946135



9 002759 946142



9 002759 946128



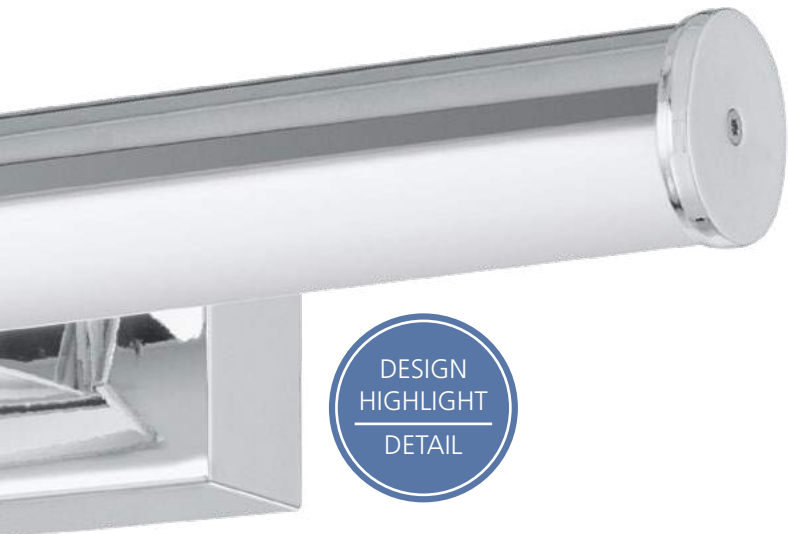

DESIGN  
HIGHLIGHT  
DETAIL



97081



97082



**97081 VADUMI**

wall light; plastic, chrome / plastic, white  
Wandleuchte; Kunststoff, chrom / Kunststoff, weiss  
applique; plastique, chrome / plastique, blanc

L 400, H 50, A 125



**97082 VADUMI**

wall light; plastic, chrome / plastic, white  
Wandleuchte; Kunststoff, chrom / Kunststoff, weiss  
applique; plastique, chrome / plastique, blanc

L 600, H 50, A 125



**97083 VADUMI**

wall light; plastic, chrome / plastic, white  
Wandleuchte; Kunststoff, chrom / Kunststoff, weiss  
applique; plastique, chrome / plastique, blanc

L 780, H 50, A 125



9 002759 970819



9 002759 970826



9 002759 970833







97083

LED





98907



98908



99731



### 98907 PANDELLA 1

mirror light; aluminium, plastic, black / plastic, white  
Spiegelleuchte; Alu, Kunststoff, schwarz / Kunststoff, weiss  
applique pour miroir; aluminium, plastique, noir / plastique, blanc

L 400, H 40, A 120



7,4W 900lm

### 98908 PANDELLA 1

mirror light; aluminium, plastic, black / plastic, white  
Spiegelleuchte; Alu, Kunststoff, schwarz / Kunststoff, weiss  
applique pour miroir; aluminium, plastique, noir / plastique, blanc

L 600, H 40, A 120



11W 1350lm

### 99731 PANDELLA 2

mirror light; aluminium, plastic, black / plastic, white  
Spiegelleuchte; Alu, Kunststoff, schwarz / Kunststoff, weiss  
applique pour miroir; aluminium, plastique, noir / plastique, blanc

L 600, H 40, A 120



11W 1400lm



9 002759 989071



9 002759 989088



9 002759 997311





98677

LED

### 98677 PANDELLA 1

mirror light; aluminium, plastic, black / plastic, white  
 Spiegelleuchte; Alu, Kunststoff, schwarz / Kunststoff, weiss  
 applique pour miroir; aluminium, plastique, noir / plastique, blanc

L 780, H 40, A 120



DESIGN  
HIGHLIGHT  
DETAIL





96064

LED



96065

LED



96066

LED

### 96064 PANDELLA 1

mirror light; aluminium, plastic, chrome, silver / plastic, white  
Spiegelleuchte; Alu, Kunststoff, chrom, silber / Kunststoff, weiss  
applique pour miroir; aluminium, plastique, chrome, argent /  
plastique, blanc

L 400, H 40, A 120



7,4W 900lm

IP44

### 96065 PANDELLA 1

mirror light; aluminium, plastic, chrome, silver / plastic, white  
Spiegelleuchte; Alu, Kunststoff, chrom, silber / Kunststoff, weiss  
applique pour miroir; aluminium, plastique, chrome, argent /  
plastique, blanc

L 600, H 40, A 120



11W 1350lm

IP44

### 96066 PANDELLA 1

mirror light; aluminium, plastic, chrome, silver / plastic, white  
Spiegelleuchte; Alu, Kunststoff, chrom, silber / Kunststoff, weiss  
applique pour miroir; aluminium, plastique, chrome, argent /  
plastique, blanc

L 780, H 40, A 120



14W 1700lm

IP44



9 002759 960643



9 002759 960650



9 002759 960667

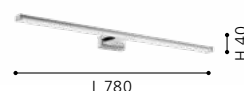



99297

LED



### 99297 PANDELLA 1

mirror light; aluminium, plastic, chrome, silver / plastic, white  
Spiegelleuchte; Alu, Kunststoff, chrom, silber / Kunststoff, weiss  
applique pour miroir; aluminium, plastique, chrome, argent /  
plastique, blanc

L 1200, H 40, A 120

 LED 14W	 neutral WHITE 1700lm		 IP44	
---	---	---	---	---

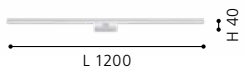

DESIGN  
HIGHLIGHT  
DETAIL





97059

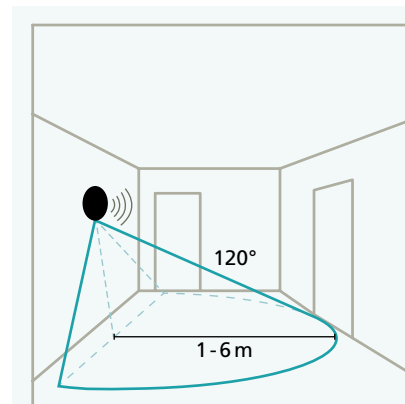

### 97059

This luminaire comes with an integrated motion sensor. The sensor is mounted invisibly behind the casing.

Diese Leuchte ist mit einem integrierten Bewegungssensor ausgestattet. Der Sensor ist unsichtbar hinter dem Gehäuse befestigt.

Ce luminaire vient avec un capteur de mouvement intégré. Le capteur est attaché invisiblement derrière le boîtier.

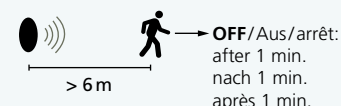
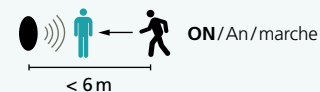

### VINCHIO

These luminaires are delivered with a wiring and connection box that is 19.5 mm deep.

Diese Leuchten werden mit einer Verkabelungs- und Anschlussbox mit einer Tiefe von 19,5 mm geliefert.

Cette luminaires sont livré avec un boîtier de câblage et de connexion d'une profondeur de 19,5 mm.



98501



### 97059 PANDELLA 2

mirror light; plastic, silver, chrome / plastic, white  
Spiegelleuchte; Kunststoff, silber, chrom / Kunststoff, weiss  
applique pour miroir; plastique, argent, chrome / plastique, blanc

L 400, H 75, A 150



### 98501 VINCHIO

mirror light; steel, chrome / plastic, white  
Spiegelleuchte; Stahl, chrom / Kunststoff, weiss  
applique pour miroir; acier, chrome / plastique, blanc

L 400, H 50, A 140



### 98502 VINCHIO

mirror light; steel, chrome / plastic, white  
Spiegelleuchte; Stahl, chrom / Kunststoff, weiss  
applique pour miroir; acier, chrome / plastique, blanc

L 600, H 50, A 140

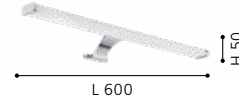



98502

LED



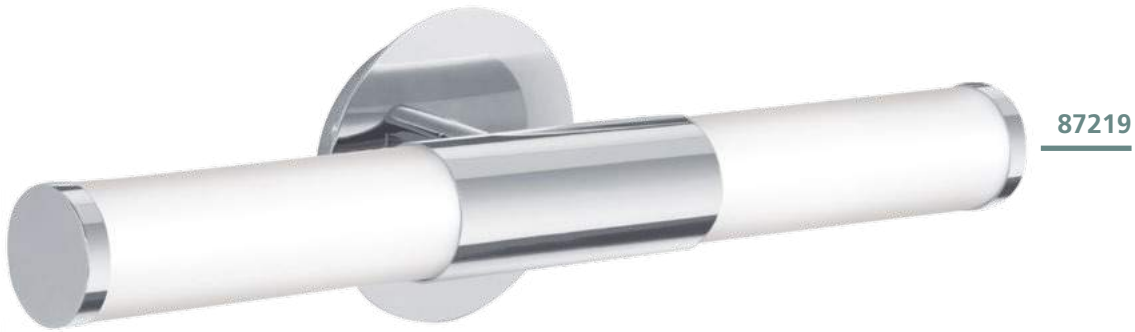

87219



87222



87219 | 87222



94989

LED

### 87219 PALMERA

wall light; steel, chrome / glass opal-matt, white  
Wandleuchte; Stahl, chrom / Glas opal-matt, weiss  
applique; acier, chrome / verre opale mat, blanc

L 460, A 110



E14 2x 40W IP44



9 002759 872199



L 460

### 87222 PALMERA

wall light; steel, satin nickel / glass opal-matt, white  
Wandleuchte; Stahl, nickel-matt / Glas opal-matt, weiss  
applique; acier, nickel mat / verre opale mat, blanc

L 460, A 110



E14 2x 40W IP44



9 002759 872229



L 460

### 94989 CAILIN

wall light; cast aluminium, chrome / satin glass, white  
Wandleuchte; Aluguss, chrom / Glas satiniert, weiss  
applique; fonte d'aluminium, chrome / verre satiné, blanc

L 90, H 270, A 115

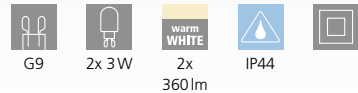

G9 2x 3W warm WHITE 2x 360lm IP44



9 002759 949891



A 115



### 85832 STICKER

mirror light; steel, chrome / glass opal-matt, white  
Spiegelleuchte; Stahl, chrom / Glas opal-matt, weiss  
applique pour miroir; acier, chrome / verre opale mat, blanc

L 70, H 115, A 95



E14



1x 40W



9 002759 858322





83406



83405



85338



83405 | 83406

### 83406 ZOLA

wall light; steel / glass opal-matt, white  
Wandleuchte; Stahl / Glas opal-matt, weiss  
applique; acier / verre opale mat, blanc

L 390, B 80



E14

2x 40W



9 002759 834067



### 83405 ZOLA

wall light; steel / glass opal-matt, white  
Wandleuchte; Stahl / Glas opal-matt, weiss  
applique; acier / verre opale mat, blanc

L 570, B 80



E14

3x 40W



9 002759 834050



### 85338 MONO

wall light; steel, chrome / satin glass, white  
Wandleuchte; Stahl, chrom / Glas satiniert, weiss  
applique; acier, chrome / verre satiné, blanc

L 340, B 70, A 65



E14

2x 40W



9 002759 853389

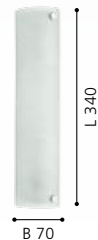





**85339**



**94987**

### 85339 MONO

wall light; steel, chrome / satin glass, white  
Wandleuchte; Stahl, chrom / Glas satiniert, weiss  
applique; acier, chrome / verre satiné, blanc

L 590, B 70, A 65



E14 3x 40W



9 002759 853396



### 94987 BARI 1

mirror light; plastic, white / glass grooved, white  
Spiegelleuchte; Kunststoff, weiss / Glas gerillt, weiss  
applique pour miroir; plastique, blanc / verre rainuré, blanc

L 350, B 60, A 85



E14 2x 25W



9 002759 949877



### 94987

This luminaire comes with an integrated power socket.

Diese Leuchte ist mit einer integrierten Steckdose ausgestattet.

Ce luminaire vient avec une prise de courant intégrée.

99202, 99203, 99206, 99207

These luminaires are protected against splash water.

Diese Leuchten sind gegen Spritzwasser geschützt.

Les luminaires sont protégées contre les éclaboussures d'eau.



	0	1	2	3
EU	X	X	✓	✓
FR	X	X	X	✓

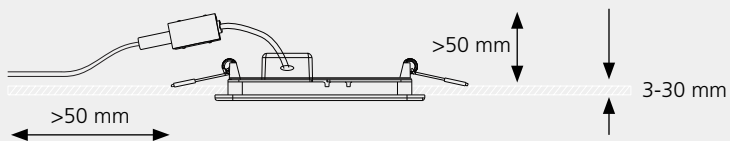

99202, 99203, 99206, 99207

Slim design and minimal installation depth. This makes it ideal for ceiling constructions with little space. Easy installation / replacement of the lights with practical connectors.

Schlanke Bauform und minimale Einbautiefe. Dadurch ideal für Deckenkonstruktionen mit wenig Platz. Einfache Montage / Austausch der Leuchten durch praktischen Verbinder.

Conception mince et profondeur d'installation minimale. Cela le rend idéal pour les constructions de plafond avec peu d'espace. Installation / remplacement facile des lumières avec des connecteurs pratiques.

99202 FUEVA 5

recessed light; steel, white / plastic, white  
Einbauleuchte; Stahl, weiss / Kunststoff, weiss  
luminaire encastrable; acier, blanc / plastique, blanc

Ø 86, ET 26



99203 FUEVA 5

recessed light; steel, white / plastic, white  
Einbauleuchte; Stahl, weiss / Kunststoff, weiss  
luminaire encastrable; acier, blanc / plastique, blanc

Ø 166, ET 26



99206 FUEVA 5

recessed light; steel, white / plastic, white  
Einbauleuchte; Stahl, weiss / Kunststoff, weiss  
luminaire encastrable; acier, blanc / plastique, blanc

Ø 86, ET 26



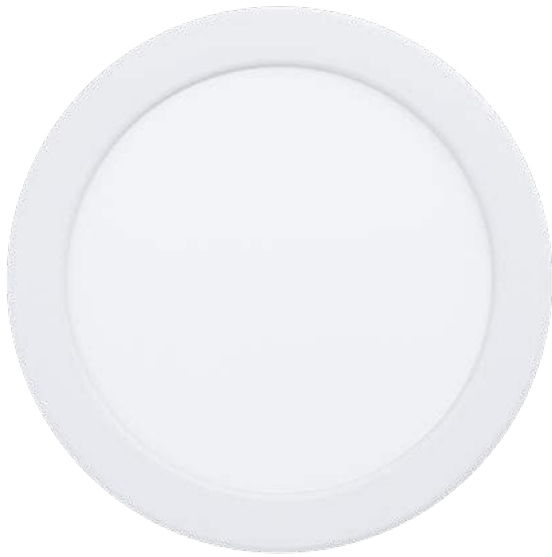

99203

LED



99206

LED

### 99207 FUEVA 5

recessed light; steel, white / plastic, white  
Einbauleuchte; Stahl, weiss / Kunststoff, weiss  
luminaire encastrable; acier, blanc / plastique, blanc

Ø 166, ET 26



10,5W

1350lm

Ø 155

IP44



9 002759 992071



Ø 166



99207

LED

99204, 99205, 99208, 99209

These luminaires are protected against splash water.

Diese Leuchten sind gegen Spritzwasser geschützt.

Les luminaires sont protégées contre les éclaboussures d'eau.



	0	1	2	3
EU	X	X	✓	✓
FR	X	X	X	✓

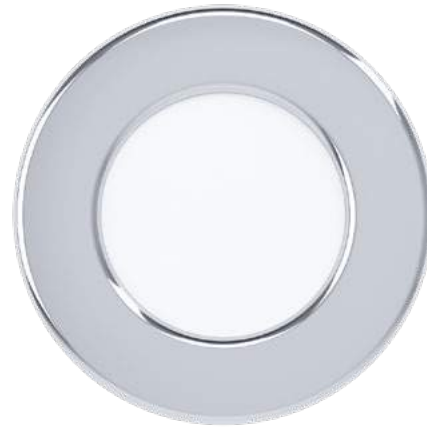

99208

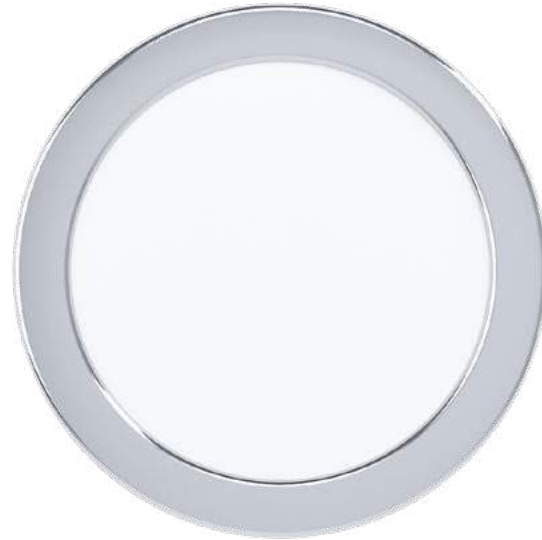

99209

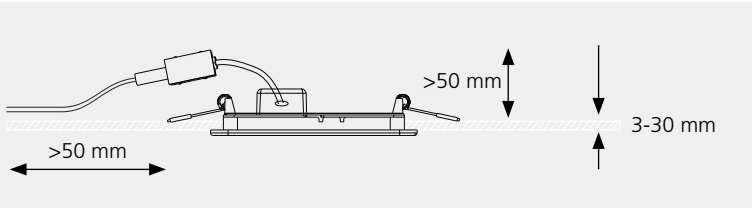

99204, 99205, 99208, 99209

Slim design and minimal installation depth. This makes it ideal for ceiling constructions with little space. Easy installation / replacement of the lights with practical connectors.

Schlanke Bauform und minimale Einbautiefe. Dadurch ideal für Deckenkonstruktionen mit wenig Platz. Einfache Montage / Austausch der Leuchten durch praktischen Verbinder.

Conception mince et profondeur d'installation minimale. Cela le rend idéal pour les constructions de plafond avec peu d'espace. Installation / remplacement facile des lumières avec des connecteurs pratiques.

99208 FUEVA 5

recessed light; steel, chrome / plastic, white  
Einbauleuchte; Stahl, chrom / Kunststoff, weiss  
luminaire encastrable; acier, chrome / plastique, blanc

Ø 86, ET 26



Ø 86

99209 FUEVA 5

recessed light; steel, chrome / plastic, white  
Einbauleuchte; Stahl, chrom / Kunststoff, weiss  
luminaire encastrable; acier, chrome / plastique, blanc

Ø 166, ET 26



Ø 166

99205 FUEVA 5

recessed light; steel, chrome / plastic, white  
Einbauleuchte; Stahl, chrom / Kunststoff, weiss  
luminaire encastrable; acier, chrome / plastique, blanc

Ø 166, ET 26



Ø 166

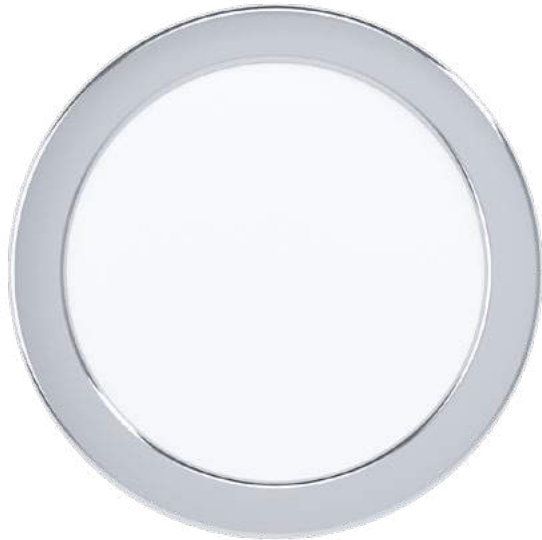

99205

LED



99204

LED

### 99204 FUEVA 5

recessed light; steel, chrome / plastic, white  
Einbauleuchte; Stahl, chrom / Kunststoff, weiss  
luminaire encastrable; acier, chrome / plastique, blanc

Ø 86, ET 26



2,7W 300lm Ø 75 IP44



Ø 86



99211, 99212, 99213, 99214

These luminaires are protected against splash water.

Diese Leuchten sind gegen Spritzwasser geschützt.

Les luminaires sont protégées contre les éclaboussures d'eau.



IP44

	0	1	2	3
EU	X	X	✓	✓
FR	X	X	X	✓



99213

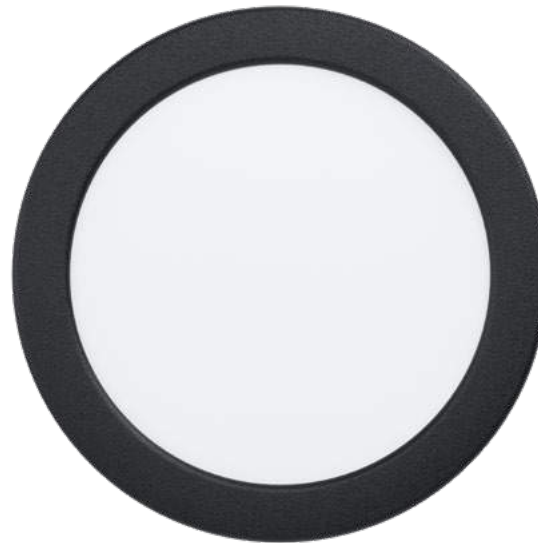

99214



99211, 99212, 99213, 99214

Slim design and minimal installation depth. This makes it ideal for ceiling constructions with little space. Easy installation / replacement of the lights with practical connectors.

Schlanke Bauform und minimale Einbautiefe. Dadurch ideal für Deckenkonstruktionen mit wenig Platz. Einfache Montage / Austausch der Leuchten durch praktischen Verbinder.

Conception mince et profondeur d'installation minimale. Cela le rend idéal pour les constructions de plafond avec peu d'espace. Installation / remplacement facile des lumières avec des connecteurs pratiques.

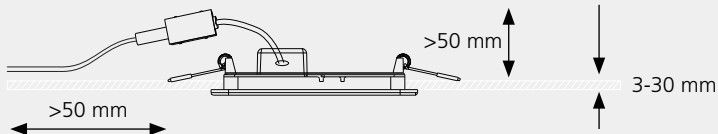

99213 FUEVA 5

recessed light; steel, black / plastic, white  
Einbauleuchte; Stahl, schwarz / Kunststoff, weiss  
luminaire encastrable; acier, noir / plastique, blanc

Ø 86, ET 26



Ø 86

99214 FUEVA 5

recessed light; steel, black / plastic, white  
Einbauleuchte; Stahl, schwarz / Kunststoff, weiss  
luminaire encastrable; acier, noir / plastique, blanc

Ø 166, ET 26



Ø 166

99212 FUEVA 5

recessed light; steel, black / plastic, white  
Einbauleuchte; Stahl, schwarz / Kunststoff, weiss  
luminaire encastrable; acier, noir / plastique, blanc

Ø 166, ET 26



Ø 166



99212

LED



99211

LED

### 99211 FUEVA 5

recessed light; steel, black / plastic, white  
Einbauleuchte; Stahl, schwarz / Kunststoff, weiss  
luminaire encastrable; acier, noir / plastique, blanc

Ø 86, ET 26

LED

2,7W

warm  
WHITE

300lm



Ø 75



IP44



Ø 86

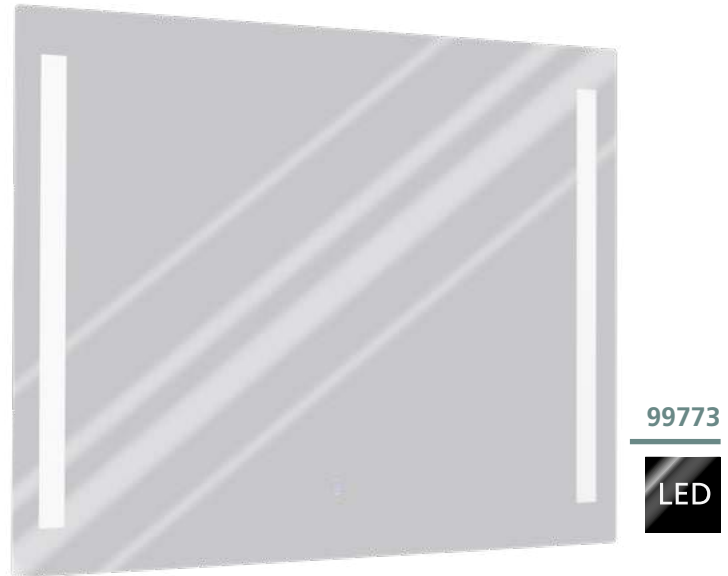

### 99772 BUENAVISTA

mirror light; aluminium, silver / mirror  
Spiegelleuchte; Alu, silber / Spiegel  
applique pour miroir; aluminium, argent / miroir

L 500, H 700, A 30

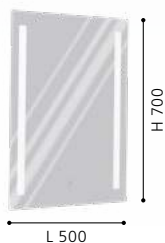
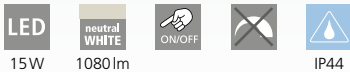

### 99773 BUENAVISTA

mirror light; aluminium, silver / mirror  
Spiegelleuchte; Alu, silber / Spiegel  
applique pour miroir; aluminium, argent / miroir

L 800, H 600, A 30

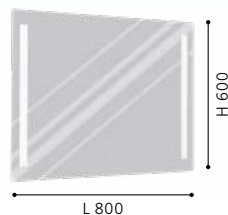
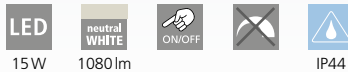

### 99774 BUENAVISTA

mirror light; aluminium, silver / mirror  
Spiegelleuchte; Alu, silber / Spiegel  
applique pour miroir; aluminium, argent / miroir

Ø 600, A 30

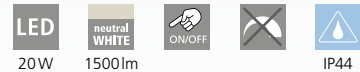



99774

LED



99838

LED

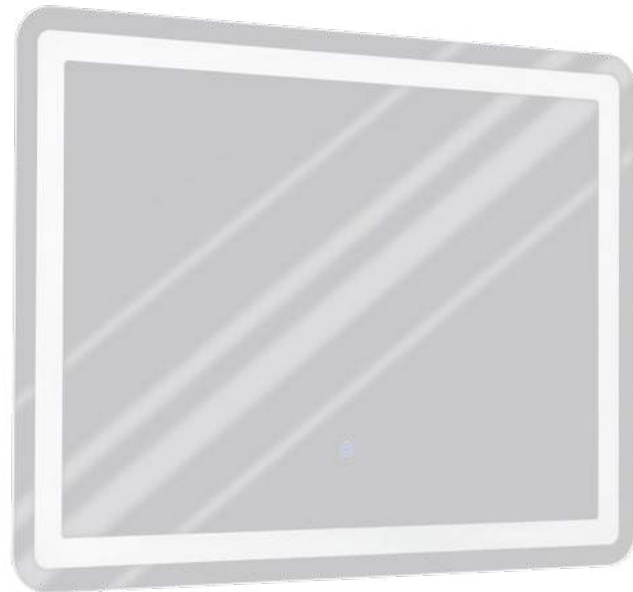

99839

LED

### 99838 BUENAVISTA 1

mirror light; aluminium, silver / mirror  
Spiegelleuchte; Alu, silber / Spiegel  
applique pour miroir; aluminium, argent / miroir

L 500, H 700, A 30



20W



1500lm



ON/OFF



IP44



9 002759 998387



L 500

H 700

### 99839 BUENAVISTA 1

mirror light; aluminium, silver / mirror  
Spiegelleuchte; Alu, silber / Spiegel  
applique pour miroir; aluminium, argent / miroir

L 800, H 600, A 30



24W



2000lm



ON/OFF



IP44



9 002759 998394

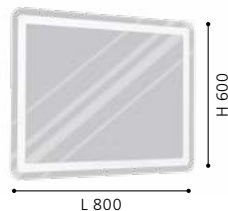

L 800

H 600

### 99853 BUENAVISTA 2

mirror light; aluminium, silver / mirror  
Spiegelleuchte; Alu, silber / Spiegel  
applique pour miroir; aluminium, argent / miroir

L 500, H 700, A 30



28W



1400lm



ON/OFF



IP44



9 002759 998530



L 500

H 700





99853



99854



### 99854 BUENAVISTA 2

mirror light; aluminium, silver / mirror  
Spiegelleuchte; Alu, silber / Spiegel  
applique pour miroir; aluminium, argent / miroir

L 800, H 600, A 30



24W



1200lm



ON/OFF



IP44



9 002759 998547

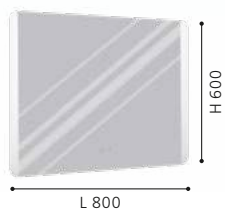

99853, 99854

The additional anti-fog function prevents the mirror from fogging up and ensures a clear view after showering.

Die zusätzliche Anti-Fog-Funktion verhindert das Beschlagen des Spiegels und sorgt für eine klare Sicht nach dem Duschen.

La fonction antibuée supplémentaire empêche le miroir de s'embuer et assure une vue dégagée après la douche.

# SPOT & TRACK LUMINAIRES

SPOT- & SCHIENENLEUCHTEN  
SPOTS & LUMINAIRES SUR RAIL

## SYSTEMATIC LIGHTING -

Our spot & track luminaires set specific highlights while optimally lighting your living rooms. No matter whether you prefer a modern or a traditional look – our range will fit any taste.

## BELEUCHTUNG MIT SYSTEM -

Mit unseren Spot- & Schienenleuchten setzen Sie gezielt Lichtakzente und sorgen zugleich für eine optimale Ausleuchtung Ihrer Wohnräume. Egal ob modern oder traditionell - unser Sortiment trifft jeden Geschmack.



## UN ÉCLAIRAGE AVEC SYSTÈME -

Nos spots et nos luminaires sur rail vous permettent d'offrir des accents ponctuels de lumière et assurent parallèlement un éclairage optimal de vos pièces d'habitat. Qu'ils soient modernes ou traditionnels - notre gamme répond à tous les goûts.



# OVERVIEW

## SPOT & TRACK LUMINAIRES

							
TOWNSHEND 3 p. 620-623	VILLABATE p. 624-627	BATALLAS p. 628-629	ESTEPERRA p. 631	VALBIANO p. 632-633	POLLICA p. 634	BERREGAS p. 636	CONSACA p. 638
							
CASIBARE p. 640	COSWARTH p. 642	CAROVIGNO p. 644	SAMBATELLO p. 646-647	TABILLANO p. 648	ZAPATA 1 p. 650	ZAPATA p. 652-653	SERAS 1 p. 654-655
							
SERAS p. 656-657	SERAS 2 p. 658-659	DAKAR 1 p. 660-661	ENEA p. 662-663	BARNHAM p. 664-665	NOCITO p. 666-667	BIMEDA p. 668-671	LOCANDA p. 672
							
VERGIANO p. 674-675	DAVIDA p. 676-677	DAVIDA 1 p. 678-679	SARRIA p. 680-683	CORBERA p. 684	ZERACO p. 686	TUKON 3 p. 688	ROTTELO p. 690-691
							
BUZZ-LED p. 692-693	MAGNUM-LED p. 694-695	VILANOVA p. 696-697	CABO 1 p. 698	PAWEDO 1 p. 698	CARDILLIO 1 p. 700-701	SALTO p. 702-703	

 This product is available in different colors and shapes./ Dieser Artikel ist in unterschiedlichen Farben und Formen verfügbar.  
Cet article est disponible en différentes couleurs et formes.









**33169**



**33171**

**33169 TOWNSHEND 3**

spot; wood, steel, brown, white  
 Spot; Holz, Stahl, braun, weiss  
 spot; bois, acier, marron, blanc

L 300, B 50



E27

2x 60W

**33171 TOWNSHEND 3**

spot; wood, steel, brown, white  
 Spot; Holz, Stahl, braun, weiss  
 spot; bois, acier, marron, blanc

L 480, B 50



E27

3x 60W

**33172 TOWNSHEND 3**

spot; wood, steel, brown, white  
 Spot; Holz, Stahl, braun, weiss  
 spot; bois, acier, marron, blanc

L 630, B 50



E27

4x 60W



9 002759 331696



L 300



9 002759 331719



L 480



9 002759 331726



L 630



33172



33168

### 33168 TOWNSHEND 3

spot; wood, steel, brown, white  
 Spot; Holz, Stahl, braun, weiss  
 spot; bois, acier, marron, blanc

L 165, B 50



E27



1x 10W

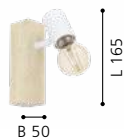



### 98112 TOWNSHEND 3

spot; wood, steel, brown, black  
 Spot; Holz, Stahl, braun, schwarz  
 spot; bois, acier, marron, noir

L 300, B 50



### 98113 TOWNSHEND 3

spot; wood, steel, brown, black  
 Spot; Holz, Stahl, braun, schwarz  
 spot; bois, acier, marron, noir

L 480, B 50



### 98114 TOWNSHEND 3

spot; wood, steel, brown, black  
 Spot; Holz, Stahl, braun, schwarz  
 spot; bois, acier, marron, noir

L 630, B 50

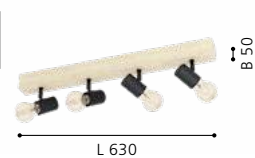
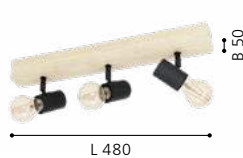
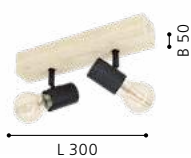



98114



98111

### 98111 TOWNSHEND 3

spot; wood, steel, brown, black  
Spot; Holz, Stahl, braun, schwarz  
spot; bois, acier, marron, noir

L 165, B 50



E27



1x 10W



9 002759 981112

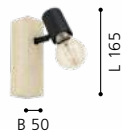



**98138**



**98139**



**98142**

### 98138 VILLABATE

spot; steel, satin nickel / fabric, grey  
Spot; Stahl, nickel-matt / Textil, grau  
spot; acier, nickel mat / tissu, gris

Ø 120



E27



1x 10W

### 98139 VILLABATE

spot; steel, satin nickel / fabric, grey  
Spot; Stahl, nickel-matt / Textil, grau  
spot; acier, nickel mat / tissu, gris

L 335, B 90



E27



2x 10W

### 98142 VILLABATE

spot; steel, satin nickel / fabric, grey  
Spot; Stahl, nickel-matt / Textil, grau  
spot; acier, nickel mat / tissu, gris

L 795, B 90



E27



4x 10W



9 002759 981389

Ø 120



9 002759 981396



L 335

B 90



9 002759 981426



L 795

B 90





98141

**98141 VILLABATE**

spot; steel, satin nickel / fabric, grey  
Spot; Stahl, nickel-matt / Textil, grau  
spot; acier, nickel mat / tissu, gris

L 575, B 90





**33646**

**33647**

**33648**

### 33646 VILLABATE

spot; steel, black / fabric, black, white  
 Spot; Stahl, schwarz / Textil, schwarz, weiss  
 spot; acier, noir / tissu, noir, blanc

L 335, B 90



E27 2x 10W

### 33647 VILLABATE

spot; steel, black / fabric, black, white  
 Spot; Stahl, schwarz / Textil, schwarz, weiss  
 spot; acier, noir / tissu, noir, blanc

L 575, B 90



E27 3x 10W

### 33648 VILLABATE

spot; steel, black / fabric, black, white  
 Spot; Stahl, schwarz / Textil, schwarz, weiss  
 spot; acier, noir / tissu, noir, blanc

L 795, B 90



E27 4x 10W



9 002759 336462



L 335



9 002759 336479



L 575



9 002759 336486



L 795



**33645**

### 33645 VILLABATE

spot; steel, black / fabric, black, white  
Spot; Stahl, schwarz / Textil, schwarz, weiss  
spot; acier, noir / tissu, noir, blanc

Ø 120



E27



1x 10W



9 002759 336455



Ø 120



DESIGN  
HIGHLIGHT  
DETAIL

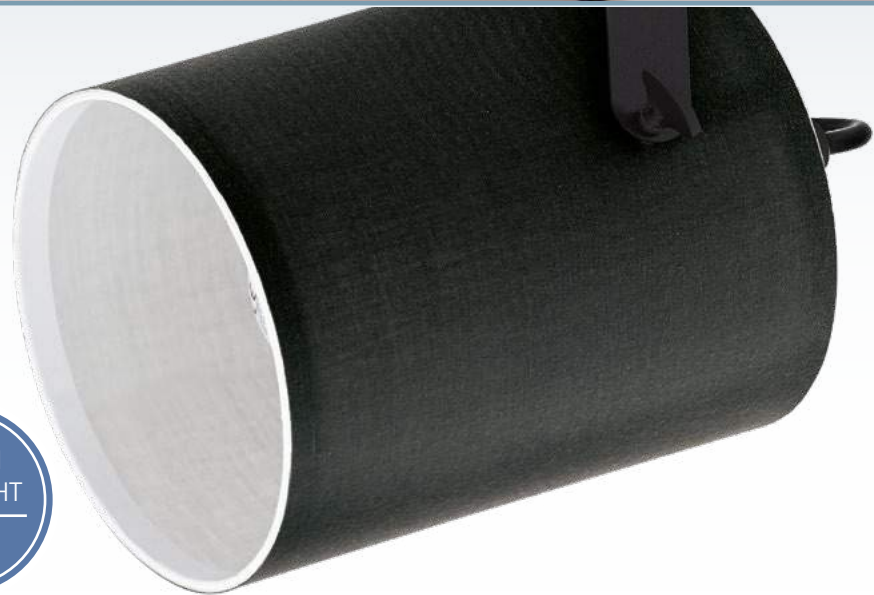



### 99488 BATALLAS

spot; wood, steel, brown, black / fabric, black, white  
 Spot; Holz, Stahl, braun, schwarz / Textil, schwarz, weiss  
 spot; bois, acier, marron, noir / tissu, noir, blanc

L 100, H 170, A 205



E27 1x 10W



9 002759 994884

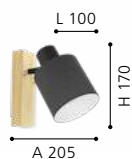

### 99489 BATALLAS

spot; wood, steel, brown, black / fabric, black, white  
 Spot; Holz, Stahl, braun, schwarz / Textil, schwarz, weiss  
 spot; bois, acier, marron, noir / tissu, noir, blanc

L 300, B 50



E27 2x 10W



9 002759 994891

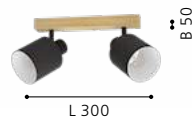

### 99491 BATALLAS

spot; wood, steel, brown, black / fabric, black, white  
 Spot; Holz, Stahl, braun, schwarz / Textil, schwarz, weiss  
 spot; bois, acier, marron, noir / tissu, noir, blanc

L 480, B 50



E27 3x 10W



9 002759 994914





99492



### 99492 BATALLAS

spot; wood, steel, brown, black / fabric, black, white  
Spot; Holz, Stahl, braun, schwarz / Textil, schwarz, weiss  
spot; bois, acier, marron, noir / tissu, noir, blanc

L 630, B 50



E27



4x 10W



9 002759 994921

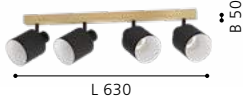





99278

DESIGN  
HIGHLIGHT  
DETAIL



99277



99276

### 99278 ESTEPERRA

spot; steel, black / fabric, black, gold  
Spot; Stahl, schwarz / Textil, schwarz, gold  
spot; acier, noir / tissu, noir, or

L 575, B 90



E27 3x 28W



9 002759 992781



L 575

### 99277 ESTEPERRA

spot; steel, black / fabric, black, gold  
Spot; Stahl, schwarz / Textil, schwarz, gold  
spot; acier, noir / tissu, noir, or

L 335, B 90



E27 2x 28W



9 002759 992774



L 335

### 99276 ESTEPERRA

spot; steel, black / fabric, black, gold  
Spot; Stahl, schwarz / Textil, schwarz, gold  
spot; acier, noir / tissu, noir, or

H 240, Ø 120



E27 1x 28W



9 002759 992767

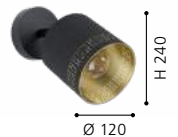

Ø 120



97536



97537



97538

### 97536 VALBIANO

spot; steel, brushed brass, satin nickel / fabric, cappuccino, gold  
 Spot; Stahl, messing-gebürstet, nickel-matt / Textil, cappuccino, gold  
 spot; acier, laiton brossé, nickel mat / tissu, cappuccino, or

L 110, B 110



E14

1x 7W

### 97537 VALBIANO

spot; steel, brushed brass, satin nickel / fabric, cappuccino, gold  
 Spot; Stahl, messing-gebürstet, nickel-matt / Textil, cappuccino, gold  
 spot; acier, laiton brossé, nickel mat / tissu, cappuccino, or

L 320, B 70



E14

2x 7W

### 97538 VALBIANO

spot; steel, brushed brass, satin nickel / fabric, cappuccino, gold  
 Spot; Stahl, messing-gebürstet, nickel-matt / Textil, cappuccino, gold  
 spot; acier, laiton brossé, nickel mat / tissu, cappuccino, or

L 560, B 70



E14

3x 7W



9 002759 975364



L 110



9 002759 975371



L 320



9 002759 975388



L 560



### 97539 VALBIANO

spot; steel, brushed brass, satin nickel / fabric, cappuccino, gold  
 Spot; Stahl, messing-gebürstet, nickel-matt / Textil, cappuccino, gold  
 spot; acier, laiton brossé, nickel mat / tissu, cappucino, or

L 780, B 70



E14



4x 7W



9 002759 975395

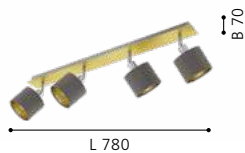



98624



98624 | 98625 | 98626



98625

### 98624 POLLICA

spot; steel, black / glass vaporized, black-transparent  
Spot; Stahl, schwarz / Glas bedampft, schwarz-transparent  
spot; acier, noir / verre vaporisé, noir transparent

L 65, H 105



E14 1x 10W

### 98625 POLLICA

spot; steel, black / glass vaporized, black-transparent  
Spot; Stahl, schwarz / Glas bedampft, schwarz-transparent  
spot; acier, noir / verre vaporisé, noir transparent

L 365, B 165



E14 2x 28W

### 98626 POLLICA

spot; steel, black / glass vaporized, black-transparent  
Spot; Stahl, schwarz / Glas bedampft, schwarz-transparent  
spot; acier, noir / verre vaporisé, noir transparent

L 640, B 220



E14 4x 28W



9 002759 986247



9 002759 986254



9 002759 986261

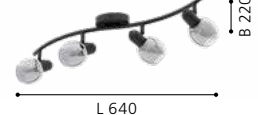





**98626**





99052



99052 | 99053 | 99054



99053

### 99052 BERREGAS

spot; steel, black, chrome / glass vaporized, black-transparent  
 Spot; Stahl, schwarz, chrom / Glas bedampft, schwarz-transparent  
 spot; acier, noir, chrome / verre vaporisé, noir transparent

Ø 110



E27



1x 28W

### 99053 BERREGAS

spot; steel, black, chrome / glass vaporized, black-transparent  
 Spot; Stahl, schwarz, chrom / Glas bedampft, schwarz-transparent  
 spot; acier, noir, chrome / verre vaporisé, noir transparent

L 440, B 110



E27



2x 40W

### 99054 BERREGAS

spot; steel, black, chrome / glass vaporized, black-transparent  
 Spot; Stahl, schwarz, chrom / Glas bedampft, schwarz-transparent  
 spot; acier, noir, chrome / verre vaporisé, noir transparent

L 775, B 110



E27



3x 40W



9 002759 990527



Ø 110



9 002759 990534



L 440

B 110



9 002759 990541



L 775

B 110



99054





99711



99711 | 99712 | 99713



99713

### 99711 CONSACA

spot; steel, black / glass vaporized, black-transparent  
Spot; Stahl, schwarz / Glas bedampft, schwarz-transparent  
spot; acier, noir / verre vaporisé, noir transparent

L 120, H 220, A 160



E27

1x 28W

### 99713 CONSACA

spot; steel, black / glass vaporized, black-transparent  
Spot; Stahl, schwarz / Glas bedampft, schwarz-transparent  
spot; acier, noir / verre vaporisé, noir transparent

L 780, H 205, A 160



E27

4x 40W

### 99712 CONSACA

spot; steel, black / glass vaporized, black-transparent  
Spot; Stahl, schwarz / Glas bedampft, schwarz-transparent  
spot; acier, noir / verre vaporisé, noir transparent

L 340, H 205, A 160



E27

2x 40W



9 002759 997113



9 002759 997137



9 002759 997120







99712





99517



99518

### 99517 CASIBARE

spot; steel, black  
Spot; Stahl, schwarz  
spot; acier, noir

L 120, H 185, A 190



E27



1x 28W



9 002759 995171



### 99518 CASIBARE

spot; steel, black  
Spot; Stahl, schwarz  
spot; acier, noir

L 335, H 175, A 180



E27



2x 28W



9 002759 995188



### 99519 CASIBARE

spot; steel, black  
Spot; Stahl, schwarz  
spot; acier, noir

L 575, H 175, A 180



E27



3x 28W



9 002759 995195





99519





### 99075 COSWARTH

spot; steel, wood, anthracite, cream-white, brown  
 Spot; Stahl, Holz, anthrazit, creme-weiss, braun  
 spot; acier, bois, anthracite, blanc crème, marron

L 480, B 140, H 240



E27

2x 40W

### 99076 COSWARTH

spot; steel, wood, anthracite, cream-white, brown  
 Spot; Stahl, Holz, anthrazit, creme-weiss, braun  
 spot; acier, bois, anthracite, blanc crème, marron

L 670, B 140, H 240



E27

3x 40W

### 99074 COSWARTH

spot; steel, wood, anthracite, cream-white, brown  
 Spot; Stahl, Holz, anthrazit, creme-weiss, braun  
 spot; acier, bois, anthracite, blanc crème, marron

L 140, H 200



E27

1x 25W



9 002759 990756



9 002759 990763



9 002759 990749





99074







### 98621 CAROVIGNO

spot; steel, black  
 Spot; Stahl, schwarz  
 spot; acier, noir

L 65, H 105



E14

1x 28W

### 98623 CAROVIGNO

spot; steel, black  
 Spot; Stahl, schwarz  
 spot; acier, noir

L 640, B 150



E14

4x 40W

### 98622 CAROVIGNO

spot; steel, black  
 Spot; Stahl, schwarz  
 spot; acier, noir

L 365, B 150



E14

2x 40W



9 002759 986216



9 002759 986230

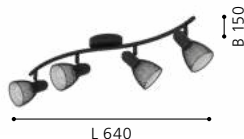

9 002759 986223







98622



98134



98135



98137

### 98134 SAMBATELLO

spot; wood, steel, brown, silver / steel, silver  
 Spot; Holz, Stahl, braun, silber / Stahl, silber  
 spot; bois, acier, marron, argent / acier, argent

L 150, H 220, A 240



E27

1x 40W

### 98135 SAMBATELLO

spot; wood, steel, brown, silver / steel, silver  
 Spot; Holz, Stahl, braun, silber / Stahl, silber  
 spot; bois, acier, marron, argent / acier, argent

L 335, B 90



E27

2x 40W

### 98137 SAMBATELLO

spot; wood, steel, brown, silver / steel, silver  
 Spot; Holz, Stahl, braun, silber / Stahl, silber  
 spot; bois, acier, marron, argent / acier, argent

L 795, B 90



E27

4x 40W



9 002759 981341

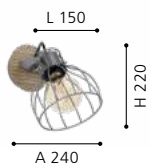

9 002759 981358



9 002759 981372





**98136**

### 98136 SAMBATELLO

spot; wood, steel, brown, silver / steel, silver  
Spot; Holz, Stahl, braun, silber / Stahl, silber  
spot; bois, acier, marron, argent / acier, argent

L 575, B 90



E27



3x 40W



9 002759 981365





### 98763 TABILLANO

spot; steel, black  
Spot; Stahl, schwarz  
spot; acier, noir

L 440, B 110



E27

2x 40W

### 98764 TABILLANO

spot; steel, black  
Spot; Stahl, schwarz  
spot; acier, noir

L 775, B 110



E27

3x 40W

### 98762 TABILLANO

spot; steel, black  
Spot; Stahl, schwarz  
spot; acier, noir

Ø 110



E27

1x 40W



9 002759 987633

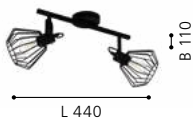

9 002759 987640



9 002759 987626







98762







32765

LED



32767

LED

### 32765 ZAPATA 1

spot; steel, black / glass, amber  
Spot; Stahl, schwarz / Glas, amber  
spot; acier, noir / verre, ambre

Ø 60



G9



1x 3W



1x  
360lm

### 32767 ZAPATA 1

spot; steel, black / glass, amber  
Spot; Stahl, schwarz / Glas, amber  
spot; acier, noir / verre, ambre

L 635, B 65



G9



4x 3W



4x  
360lm

### 32766 ZAPATA 1

spot; steel, black / glass, amber  
Spot; Stahl, schwarz / Glas, amber  
spot; acier, noir / verre, ambre

L 360, B 65



G9



2x 3W



2x  
360lm



9 002759 327651



9 002759 327675



9 002759 327668





32766

LED



95545

LED



95546

LED



95548

LED



### 95545 ZAPATA

spot; steel, copper / satin glass, white  
Spot; Stahl, kupfer / Glas satiniert, weiss  
spot; acier, cuivre / verre satiné, blanc

Ø 60



G9



1x 3W



warm  
WHITE  
1x  
360lm

### 95546 ZAPATA

spot; steel, copper / satin glass, white  
Spot; Stahl, kupfer / Glas satiniert, weiss  
spot; acier, cuivre / verre satiné, blanc

L 360, B 65



G9



2x 3W



warm  
WHITE  
2x  
360lm

### 95548 ZAPATA

spot; steel, copper / satin glass, white  
Spot; Stahl, kupfer / Glas satiniert, weiss  
spot; acier, cuivre / verre satiné, blanc

L 635, B 65



G9



4x 3W



warm  
WHITE  
4x  
360lm



9 002759 955458



Ø 60



9 002759 955465



B 65

L 360



9 002759 955489



B 65

L 635



95547

LED

**95547 ZAPATA**

spot; steel, copper / satin glass, white  
 Spot; Stahl, kupfer / Glas satiniert, weiss  
 spot; acier, cuivre / verre satiné, blanc

L 515, B 65







98393

LED



98394

LED



98396

LED

### 98393 SERAS 1

spot; steel, white  
Spot; Stahl, weiss  
spot; acier, blanc

Ø 100



GU10



1x 3W



1x  
warm  
WHITE  
250lm

### 98394 SERAS 1

spot; steel, white  
Spot; Stahl, weiss  
spot; acier, blanc

L 370, B 65



GU10



2x 3W



2x  
warm  
WHITE  
250lm

### 98396 SERAS 1

spot; steel, white  
Spot; Stahl, weiss  
spot; acier, blanc

L 770, B 65



GU10



4x 3W



4x  
warm  
WHITE  
250lm



9 002759 983932



Ø 100



9 002759 983949



L 370



9 002759 983963



L 770





98395

LED

### 98395 SERAS 1

spot; steel, white  
Spot; Stahl, weiss  
spot; acier, blanc

L 595, B 65



GU10



3x 3W



warm  
WHITE  
3x  
250lm



9 002759 983956

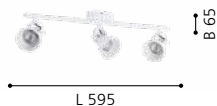



96552

LED



DESIGN  
HIGHLIGHT  
DETAIL



### 96552 SERAS

spot; steel, nickel-antique, creme  
Spot; Stahl, nickel-antik, creme  
spot; acier, nickel-antique, crème

Ø 100



GU10



1x 3W



warm  
WHITE  
1x  
250lm



9 002759 965525



INCL.

Ø 100





96553

LED



96554

LED



96555

LED

### 96553 SERAS

spot; steel, nickel-antique, creme  
Spot; Stahl, nickel-antik, creme  
spot; acier, nickel-antique, crème

L 370, B 65

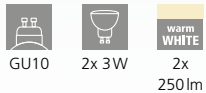

### 96554 SERAS

spot; steel, nickel-antique, creme  
Spot; Stahl, nickel-antik, creme  
spot; acier, nickel-antique, crème

L 595, B 65

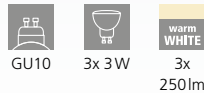

### 96555 SERAS

spot; steel, nickel-antique, creme  
Spot; Stahl, nickel-antik, creme  
spot; acier, nickel-antique, crème

L 770, B 65

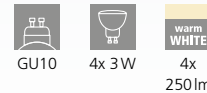



98398

LED



98397

LED

### 98398 SERAS 2

spot; steel, black  
Spot; Stahl, schwarz  
spot; acier, noir

L 370, B 65



GU10



2x 3W



warm  
WHITE

2x

250lm



9 002759 983987



INCL.



L 370



98399

LED



98408

LED

### 98397 SERAS 2

spot; steel, black  
Spot; Stahl, schwarz  
spot; acier, noir

Ø 100

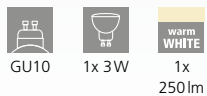

### 98399 SERAS 2

spot; steel, black  
Spot; Stahl, schwarz  
spot; acier, noir

L 595, B 65

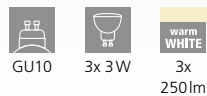

### 98408 SERAS 2

spot; steel, black  
Spot; Stahl, schwarz  
spot; acier, noir

L 770, B 65

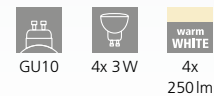

9 002759 983970



9 002759 983994



9 002759 984083







DESIGN  
HIGHLIGHT  
DETAIL



88472



88475

### 88472 DAKAR 1

spot; steel, satin nickel / glass wiping technique, white  
Spot; Stahl, nickel-matt / Glas Wischtechnik, weiss  
spot; acier, nickel mat / technique d'essuie de verre, blanc

L 105, B 65



E14

1x 25W



9 002759 884727



L 105

### 88475 DAKAR 1

spot; steel, satin nickel / glass wiping technique, white  
Spot; Stahl, nickel-matt / Glas Wischtechnik, weiss  
spot; acier, nickel mat / technique d'essuie de verre, blanc

Ø 295



E14

3x 40W



9 002759 884758



Ø 295

### 88474 DAKAR 1

spot; steel, satin nickel / glass wiping technique, white  
Spot; Stahl, nickel-matt / Glas Wischtechnik, weiss  
spot; acier, nickel mat / technique d'essuie de verre, blanc

L 650, B 100



E14

4x 40W



9 002759 884741



L 650

B 100



**88474**



**88473**

### 88473 DAKAR 1

spot; steel, satin nickel / glass wiping technique, white  
 Spot; Stahl, nickel-matt / Glas Wischtechnik, weiss  
 spot; acier, nickel mat / technique d'essuie de verre, blanc

L 370, B 100



E14



2x 40W



9 002759 884734





90984



90986



90985

### 90984 ENEA

spot; steel, satin nickel / satin glass, white  
Spot; Stahl, nickel-matt / Glas satiniert, weiss  
spot; acier, nickel mat / verre satiné, blanc

L 300, B 70



E14

2x 40W

### 90986 ENEA

spot; steel, satin nickel / satin glass, white  
Spot; Stahl, nickel-matt / Glas satiniert, weiss  
spot; acier, nickel mat / verre satiné, blanc

Ø 265



E14

3x 40W

### 90985 ENEA

spot; steel, satin nickel / satin glass, white  
Spot; Stahl, nickel-matt / Glas satiniert, weiss  
spot; acier, nickel mat / verre satiné, blanc

L 500, B 70



E14

3x 40W



9 002759 909840



9 002759 909864



9 002759 909857





90982

### 90982 ENEA

spot; steel, satin nickel / satin glass, white  
Spot; Stahl, nickel-matt / Glas satiniert, weiss  
spot; acier, nickel mat / verre satiné, blanc

L 190, B 70



E14



1x 25W



9 002759 909826

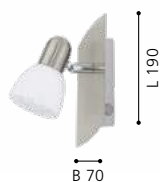



### 94585 BARNHAM

spot; steel, black, copper  
Spot; Stahl, schwarz, kupfer  
spot; acier, noir, cuivre

L 395, B 70

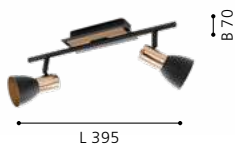
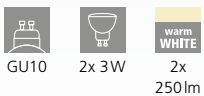

### 94586 BARNHAM

spot; steel, black, copper  
Spot; Stahl, schwarz, kupfer  
spot; acier, noir, cuivre

L 585, B 70

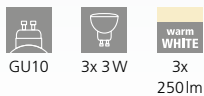

### 94587 BARNHAM

spot; steel, black, copper  
Spot; Stahl, schwarz, kupfer  
spot; acier, noir, cuivre

L 780, B 70

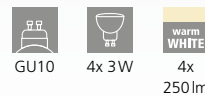





94587

LED



94584

LED

**94584 BARNHAM**

spot; steel, black, copper  
 Spot; Stahl, schwarz, kupfer  
 spot; acier, noir, cuivre

L 165, B 70



GU10



1x 3W



warm  
 WHITE  
 1x  
 250lm



9 002759 945848



INCL.



B 70

L 165



95482

LED



95483

LED



95485

LED

### 95482 NOCITO

spot; steel, black, gold  
Spot; Stahl, schwarz, gold  
spot; acier, noir, or

Ø 110



GU10



1x 3W



1x  
warm  
WHITE  
250lm



9 002759 954826



Ø 110



### 95483 NOCITO

spot; steel, black, gold  
Spot; Stahl, schwarz, gold  
spot; acier, noir, or

L 360, B 105



GU10



2x 3W



2x  
warm  
WHITE  
250lm



9 002759 954833



L 360

### 95485 NOCITO

spot; steel, black, gold  
Spot; Stahl, schwarz, gold  
spot; acier, noir, or

L 760, B 105



GU10



4x 3W



4x  
warm  
WHITE  
250lm



9 002759 954857



L 760



95484

LED

**95484 NOCITO**

spot; steel, black, gold

Spot; Stahl, schwarz, gold

spot; acier, noir, or

L 585, B 105



GU10



3x 3W



warm  
WHITE  
3x  
250lm



9 002759 954840





31001

LED



31003

LED



31004

LED

### 31001 BIMEDA

spot; steel, white, chrome  
Spot; Stahl, weiss, chrom  
spot; acier, blanc, chrome

Ø 70

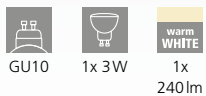

### 31003 BIMEDA

spot; steel, white, chrome  
Spot; Stahl, weiss, chrom  
spot; acier, blanc, chrome

L 290, H 345

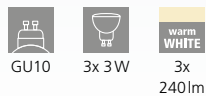

### 31004 BIMEDA

spot; steel, white, chrome  
Spot; Stahl, weiss, chrom  
spot; acier, blanc, chrome

L 640, B 100

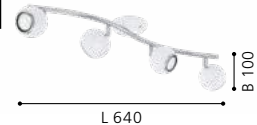
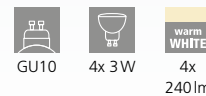





31002

LED

### 31002 BIMEDA

spot; steel, white, chrome  
 Spot; Stahl, weiss, chrom  
 spot; acier, blanc, chrome

L 365



GU10



2x 3W



warm  
 WHITE  
 2x  
 240lm



9 002759 310028



L 365





31005

LED



DESIGN  
HIGHLIGHT  
DETAIL

### 31005 BIMEDA

spot; steel, nickel-nero, chrome  
Spot; Stahl, nickel-nero, chrom  
spot; acier, nickel nero, chrome

Ø 70



GU10



1x 3W



1x  
warm  
WHITE  
240lm





31008

LED



31007

LED



31006

LED

### 31006 BIMEDA

spot; steel, nickel-nero, chrome  
Spot; Stahl, nickel-nero, chrom  
spot; acier, nickel nero, chrome

L 365

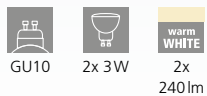

### 31007 BIMEDA

spot; steel, nickel-nero, chrome  
Spot; Stahl, nickel-nero, chrom  
spot; acier, nickel nero, chrome

L 290, H 345

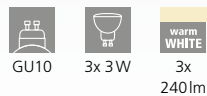

### 31008 BIMEDA

spot; steel, nickel-nero, chrome  
Spot; Stahl, nickel-nero, chrom  
spot; acier, nickel nero, chrome

L 640, B 100

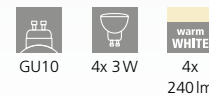

9 002759 310066



L 365



9 002759 310073



L 290

H 345



9 002759 310080



L 640

B 100

DESIGN  
HIGHLIGHT  
DETAIL



94251

LED

### 94251 LOCANDA

ceiling light; steel, satin nickel, chrome  
Deckenleuchte; Stahl, nickel-matt, chrom  
plafonnier; acier, nickel mat, chrome

L 700, B 660



GU10



5x 3W



5x  
warm  
WHITE  
240lm

### 94252 LOCANDA

ceiling light; steel, white, chrome  
Deckenleuchte; Stahl, weiss, chrom  
plafonnier; acier, blanc, chrome

L 700, B 660



GU10



5x 3W



5x  
warm  
WHITE  
240lm



9 002759 942519



L 700

B 660



9 002759 942526



L 700

B 660



94252

LED







97506

LED



97507

LED

### 97506 VERGIANO

spot; aluminium, steel, white, satin nickel  
 Spot; Alu, Stahl, weiss, nickel-matt  
 spot; aluminium, acier, blanc, nickel mat

L 70, H 165



GU10



1x 5W



warm  
 WHITE  
 1x  
 400lm



9 002759 975067



### 97507 VERGIANO

spot; aluminium, steel, white, satin nickel  
 Spot; Alu, Stahl, weiss, nickel-matt  
 spot; aluminium, acier, blanc, nickel mat

L 390, B 70



GU10



2x 5W



warm  
 WHITE  
 2x  
 400lm



9 002759 975074

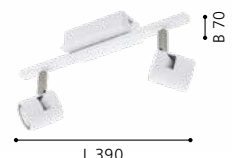





97508

LED

97509

LED

STEP DIMMING  
25/50/100%

97506

97508

97507

97509

**97508 VERGIANO**

spot; aluminium, steel, white, satin nickel  
Spot; Alu, Stahl, weiss, nickel-matt  
spot; aluminium, acier, blanc, nickel mat

L 690, B 70

GU10   
 3x 5W   
 warm WHITE  
 3x 400lm

**97509 VERGIANO**

spot; aluminium, steel, white, satin nickel  
Spot; Alu, Stahl, weiss, nickel-matt  
spot; aluminium, acier, blanc, nickel mat

L 980, B 70

GU10   
 4x 5W   
 warm WHITE  
 4x 400lm



9 002759 975081



9 002759 975098

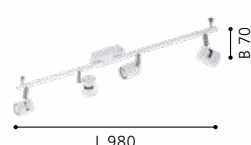



92084

LED



92085

LED



92086

LED

### 92084 DAVIDA

spot; steel, chrome, white  
Spot; Stahl, chrom, weiss  
spot; acier, chrome, blanc

L 165, B 70



GU10



1x 5W



warm  
WHITE  
1x  
400lm



INCL.



9 002759 920845



INCL.

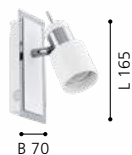

B 70

### 92085 DAVIDA

spot; steel, chrome, white  
Spot; Stahl, chrom, weiss  
spot; acier, chrome, blanc

L 390, B 70



GU10



2x 5W



warm  
WHITE  
2x  
400lm



INCL.



9 002759 920852



INCL.

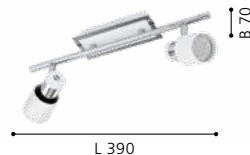

L 390

### 92086 DAVIDA

spot; steel, chrome, white  
Spot; Stahl, chrom, weiss  
spot; acier, chrome, blanc

L 580, B 70



GU10



3x 5W



warm  
WHITE  
3x  
400lm



INCL.



9 002759 920869



INCL.



L 580



92087

LED

**92087 DAVIDA**

spot; steel, chrome, white  
Spot; Stahl, chrom, weiss  
spot; acier, chrome, blanc

L 780, B 70



GU10



4x 5W



warm  
WHITE  
4x  
400lm



9 002759 920876



DESIGN  
HIGHLIGHT  
DETAIL





30833

LED



30832

LED

### 30832 DAVIDA 1

spot; steel, nickel-nero  
Spot; Stahl, nickel-nero  
spot; acier, nickel noir

L 165, B 70



GU10



1x 5W



warm  
WHITE

1x

400lm



9 002759 308322



INCL.





30834

LED



30835

LED

### 30833 DAVIDA 1

spot; steel, nickel-nero  
Spot; Stahl, nickel-nero  
spot; acier, nickel noir

L 390, B 70

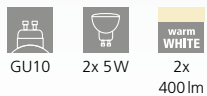

L 390

### 30834 DAVIDA 1

spot; steel, nickel-nero  
Spot; Stahl, nickel-nero  
spot; acier, nickel noir

L 580, B 70

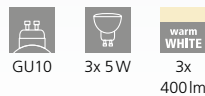

L 580

### 30835 DAVIDA 1

spot; steel, nickel-nero  
Spot; Stahl, nickel-nero  
spot; acier, nickel noir

L 780, B 70

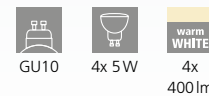

L 780





94962

LED



94958

LED

**94962 SARRIA**

spot; steel, white, chrome  
 Spot; Stahl, weiss, chrom  
 spot; acier, blanc, chrome

L 240, H 260



GU10



4x 4,5W



warm  
 WHITE  
 4x  
 345lm

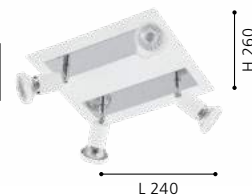

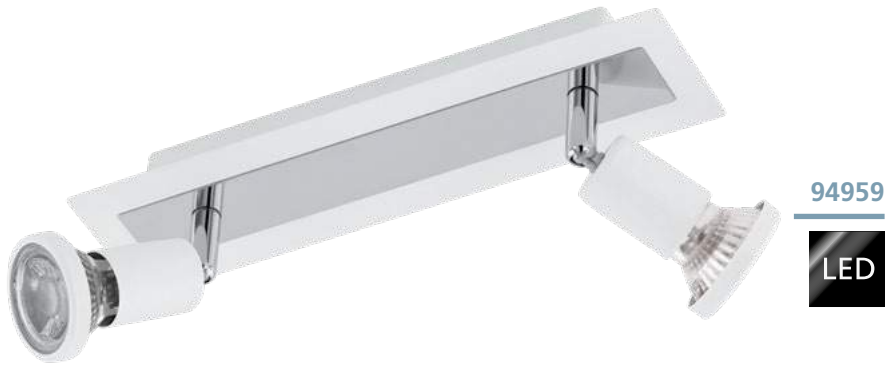

### 94958 SARRIA

spot; steel, white, chrome  
Spot; Stahl, weiss, chrom  
spot; acier, blanc, chrome

L 120, B 60

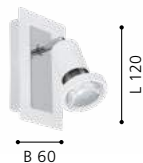
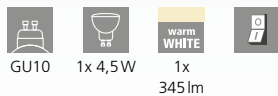

### 94959 SARRIA

spot; steel, white, chrome  
Spot; Stahl, weiss, chrom  
spot; acier, blanc, chrome

L 300, B 70

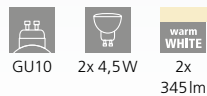

### 94961 SARRIA

spot; steel, white, chrome  
Spot; Stahl, weiss, chrom  
spot; acier, blanc, chrome

L 460, B 70

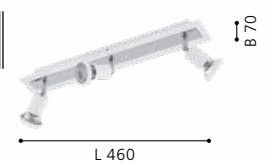
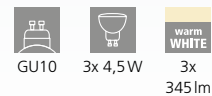



94963

LED



94966

LED



94964

LED

### 94963 SARRIA

spot; steel, black, chrome  
Spot; Stahl, schwarz, chrom  
spot; acier, noir, chrome

L 120, B 60

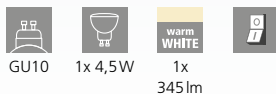

### 94964 SARRIA

spot; steel, black, chrome  
Spot; Stahl, schwarz, chrom  
spot; acier, noir, chrome

L 300, B 70

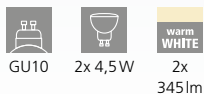

### 94966 SARRIA

spot; steel, black, chrome  
Spot; Stahl, schwarz, chrom  
spot; acier, noir, chrome

L 240, H 260

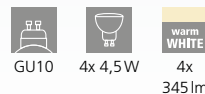

9 002759 949631



9 002759 949648



9 002759 949662





94965

LED

### 94965 SARRIA

spot; steel, black, chrome  
Spot; Stahl, schwarz, chrom  
spot; acier, noir, chrome

L 460, B 70



GU10



3x 4,5W



warm  
WHITE  
3x  
345 lm



9 002759 949655



INCL.



L 460

B 70



DESIGN  
HIGHLIGHT  
DETAIL



93672

LED



93673

LED

### CORBERA

Designer spot series with special spot heads.

Spotserie mit Spotköpfen in besonderem Design.

Série de spot avec des têtes de spot spéciales.

#### 93672 CORBERA

spot; steel, plastic, chrome  
Spot; Stahl, Kunststoff, chrom  
spot; acier, plastique, chrome

L 120, B 60



GU10



1x 3W



1x  
warm  
WHITE  
240lm



INCL.



9 002759 936723



INCL.

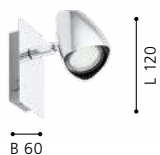

B 60

L 120

#### 93673 CORBERA

spot; steel, plastic, chrome  
Spot; Stahl, Kunststoff, chrom  
spot; acier, plastique, chrome

L 390, B 70



GU10



2x 3W



2x  
warm  
WHITE  
240lm



INCL.



9 002759 936730



INCL.



L 390

B 70

#### 93674 CORBERA

spot; steel, plastic, chrome  
Spot; Stahl, Kunststoff, chrom  
spot; acier, plastique, chrome

L 585, B 70



GU10



3x 3W



3x  
warm  
WHITE  
240lm



INCL.



9 002759 936747



INCL.

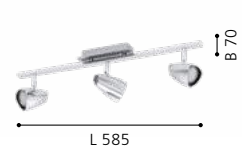

L 585

B 70





93674

LED

DESIGN  
HIGHLIGHT  
DETAIL





93679  
LED

**93679 ZERACO**

spot; steel, plastic, satin nickel  
Spot; Stahl, Kunststoff, nickel-matt  
spot; acier, plastique, nickel mat

L 940, B 120



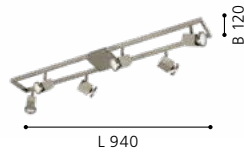

  
 GU10 6x 5W 6x  
 400lm



**93678 ZERACO**

spot; steel, plastic, satin nickel  
Spot; Stahl, Kunststoff, nickel-matt  
spot; acier, plastique, nickel mat

L 700, B 120

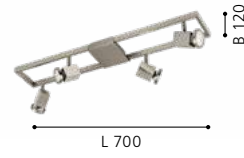

  
 GU10 4x 5W 4x  
 400lm





93678

LED



### 94145 TUKON 3

spot; steel, satin nickel  
Spot; Stahl, nickel-matt  
spot; acier, nickel mat

L 280, B 70

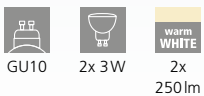

### 94146 TUKON 3

spot; steel, satin nickel  
Spot; Stahl, nickel-matt  
spot; acier, nickel mat

L 460, B 70

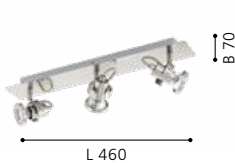
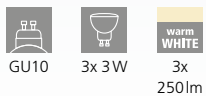

### 94144 TUKON 3

spot; steel, satin nickel  
Spot; Stahl, nickel-matt  
spot; acier, nickel mat

L 165, B 70

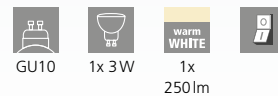





94144

LED





90915

LED



90914

LED



90916

LED

### 90915 ROTTELO

spot; steel, satin nickel, chrome  
Spot; Stahl, nickel-matt, chrom  
spot; acier, nickel mat, chrome

L 280, B 70



GU10



2x 5W



warm  
WHITE  
2x  
400lm



9 002759 909154



L 280

### 90914 ROTTELO

spot; steel, satin nickel, chrome  
Spot; Stahl, nickel-matt, chrom  
spot; acier, nickel mat, chrome

L 120, B 60



GU10



1x 5W



warm  
WHITE  
1x  
400lm



9 002759 909147



B 60

### 90916 ROTTELO

spot; steel, satin nickel, chrome  
Spot; Stahl, nickel-matt, chrom  
spot; acier, nickel mat, chrome

L 260, B 240



GU10



4x 5W



warm  
WHITE  
4x  
400lm



9 002759 909161



L 260



90917



90927



### 90917 ROTTELO

spot; steel, satin nickel, chrome  
 Spot; Stahl, nickel-matt, chrom  
 spot; acier, nickel mat, chrome

L 780, B 70

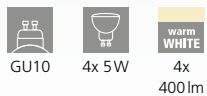

### 90927 ROTTELO

spot; steel, satin nickel, chrome  
 Spot; Stahl, nickel-matt, chrom  
 spot; acier, nickel mat, chrome

L 1160, B 70

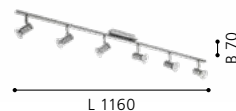
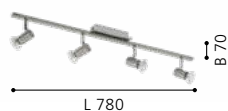
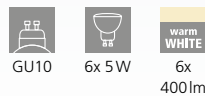



92599

LED



92595

LED



92596

LED

### 92599 BUZZ-LED

spot; steel, satin nickel  
Spot; Stahl, nickel-matt  
spot; acier, nickel mat

L 1050, B 65



GU10



6x 3W



warm  
WHITE

6x  
240lm



9 002759 925994

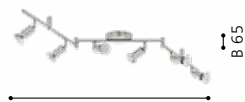

L 1050

### 92595 BUZZ-LED

spot; steel, satin nickel  
Spot; Stahl, nickel-matt  
spot; acier, nickel mat

Ø 60



GU10



1x 3W



warm  
WHITE

1x  
240lm



9 002759 925956



Ø 60

### 92596 BUZZ-LED

spot; steel, satin nickel  
Spot; Stahl, nickel-matt  
spot; acier, nickel mat

L 285, B 65



GU10



2x 3W



warm  
WHITE

2x  
240lm



9 002759 925963



L 285



92597

LED



92598

LED

### 92597 BUZZ-LED

spot; steel, satin nickel  
Spot; Stahl, nickel-matt  
spot; acier, nickel mat

L 485, B 65



GU10



3x 3W



3x  
warm  
WHITE  
240lm



9 002759 925970



L 485

B 65

### 92598 BUZZ-LED

spot; steel, satin nickel  
Spot; Stahl, nickel-matt  
spot; acier, nickel mat

L 685, B 65



GU10



4x 3W



4x  
warm  
WHITE  
240lm



9 002759 925987



L 685

B 65



92641

LED



92642

LED



92643

LED

### 92641 MAGNUM-LED

spot; steel, satin nickel, chrome  
Spot; Stahl, nickel-matt, chrom  
spot; acier, nickel mat, chrome

Ø 70



GU10



1x 3W



1x

240lm



9 002759 926410



### 92642 MAGNUM-LED

spot; steel, satin nickel, chrome  
Spot; Stahl, nickel-matt, chrom  
spot; acier, nickel mat, chrome

L 330, B 105



GU10



2x 3W



2x

240lm



9 002759 926427



L 330

### 92643 MAGNUM-LED

spot; steel, satin nickel, chrome  
Spot; Stahl, nickel-matt, chrom  
spot; acier, nickel mat, chrome

L 255, H 295



GU10



3x 3W



3x

240lm



9 002759 926434



L 255





95824

LED



92644

LED



92645

LED

**95824 MAGNUM LED**

spot; steel, satin nickel, chrome  
Spot; Stahl, nickel-matt, chrom  
spot; acier, nickel mat, chrome

Ø 180



GU10



3x 3W



3x  
warm  
WHITE  
240lm



Ø 180

**92644 MAGNUM-LED**

spot; steel, satin nickel, chrome  
Spot; Stahl, nickel-matt, chrom  
spot; acier, nickel mat, chrome

L 645, B 105



GU10



4x 3W



4x  
warm  
WHITE  
240lm



L 645

**92645 MAGNUM-LED**

spot; steel, satin nickel, chrome  
Spot; Stahl, nickel-matt, chrom  
spot; acier, nickel mat, chrome

L 1050



GU10



6x 3W



6x  
warm  
WHITE  
240lm



L 1050



93359

LED



93359



93358



94609

### 93359 VILANOVA

system; aluminium, steel, aluminium, chrome  
 System; Alu, Stahl, alu, chrom  
 système; aluminium, acier, aluminium, chrome

L 2000, H 200



GU10



5x 3W



warm  
 WHITE  
 5x  
 240lm



9 002759 933593



L 2000

### 94609 VILANOVA

accessory; steel, satin nickel  
 Zubehör; Stahl, nickel-matt  
 accessoire; acier, nickel mat

L 395



9 002759 946098



L 395



93358

LED

## 93358 VILANOVA

system; aluminium, steel, aluminium, chrome / glass, white, clear  
 System; Alu, Stahl, alu, chrom / Glas, weiss, klar  
 système; aluminium, acier, aluminium, chrome / verre, blanc, clair

L 2000, H 200



GU10



5x 5W



warm  
WHITE  
5x  
400lm



9 002759 933586



INCL.



L 2000

## 94609

Set to connect two Vilanova (93359, 93358, not suitable for 94418) tracks:

- > 250mm cable
- > 2 end parts
- > 1 straight connector for direct connection

Verbindungsset für 2 Vilanova (93359, 93358, nicht für 94418) Schienen:

- > 250mm Kabel
- > 2 Endstücke
- > 1 Verbinder für eine direkte Verbindung

Set de connexion pour deux rails de Vilanova (93359, 93358, pas 94418):

- > câble de 250mm
- > 2 pièces d'about
- > 1 connecteur pour une connexion directe





93085

LED

DESIGN  
HIGHLIGHT  
DETAIL

### 93085 CABO 1

wall / ceiling light; steel, chrome / satin glass, white, clear  
Wand- / Deckenleuchte; Stahl, chrom / Glas satiniert, weiss, klar  
applique / plafonnier; acier, chrome / verre satiné, blanc, clair

H 100, Ø 290

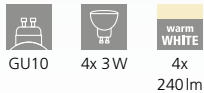

### 32001 PAWEDO 1

wall / ceiling light; steel, satin nickel, chrome / glass, white, clear  
Wand- / Deckenleuchte; Stahl, nickel-matt, chrom / Glas, weiss, klar  
applique / plafonnier; acier, nickel mat, chrome / verre, blanc, clair

Ø 290

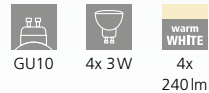

9 002759 930851



Ø 290



9 002759 320010



Ø 290



32001

LED





96182

LED



96178

LED



96179

LED

### 96182 CARDILLIO 1

spot; aluminium, steel, aluminium, chrome / plastic, satiné  
Spot; Alu, Stahl, alu, chrom / Kunststoff, satiniert  
spot; aluminium, acier, aluminium, chrome / plastique, satiné

### 96178 CARDILLIO 1

spot; aluminium, steel, aluminium, chrome / plastic, satiné  
Spot; Alu, Stahl, alu, chrom / Kunststoff, satiniert  
spot; aluminium, acier, aluminium, chrome / plastique, satiné

### 96179 CARDILLIO 1

spot; aluminium, steel, aluminium, chrome / plastic, satiné  
Spot; Alu, Stahl, alu, chrom / Kunststoff, satiniert  
spot; aluminium, acier, aluminium, chrome / plastique, satiné

L 985, B 85

LED

4x 3,2W

warm WHITE

4x 400lm

LED

2x 3,3W

warm WHITE

2x 360lm



9 002759 961824



L 225, B 65

LED

1x 3,2W

warm WHITE

1x 400lm

LED

1x 2,2W

warm WHITE

1x 240lm



9 002759 961787



L 390, B 85

LED

2x 3,2W

warm WHITE

2x 400lm

LED

1x 3,3W

warm WHITE

1x 360lm



9 002759 961794

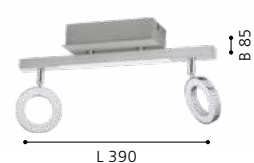



96181



96183



### 96181 CARDILLIO 1

spot; aluminium, steel, aluminium, chrome / plastic, satiné  
 Spot; Alu, Stahl, alu, chrom / Kunststoff, satiniert  
 spot; aluminium, acier, aluminium, chrome / plastique, satiné

L 690, B 85

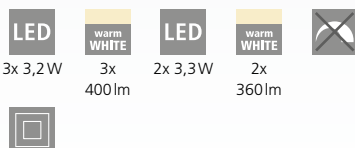

9 002759 961817

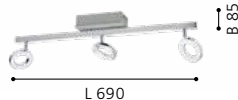

### 96183 CARDILLIO 1

spot; aluminium, steel, aluminium, chrome / plastic, satiné  
 Spot; Alu, Stahl, alu, chrom / Kunststoff, satiniert  
 spot; aluminium, acier, aluminium, chrome / plastique, satiné

L 1585, B 85

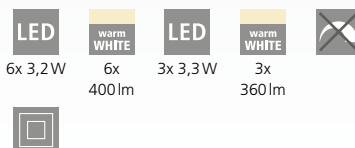

9 002759 961831



### CARDILLIO 1

These luminaires have different lighting sources. Profil lights combined with spot heads create basic lighting as well as accent lighting.

Diese Leuchten verfügen über unterschiedliche Lichtquellen. Profilleuchten kombiniert mit Spotköpfen schaffen sowohl Grundlicht als auch Akzentbeleuchtung.

Ces luminaires ont des sources d'éclairage différentes. La combinaison entre un éclairage sur la base du produit et un spot vous permet d'avoir un éclairage général mais aussi directionnel.



95629

LED



DESIGN  
HIGHLIGHT  
DETAIL

### 95629 SALTO

spot; steel, chrome / plastic, satiné  
Spot; Stahl, chrom / Kunststoff, satiniert  
spot; acier, chrome / plastique, satiné

L 360, B 120

LED

2x 5,4W

warm  
WHITE

2x  
640lm



9 002759 956295





95628

LED



95631

LED



95632

LED

### 95628 SALTO

spot; steel, chrome / plastic, satiné  
Spot; Stahl, chrom / Kunststoff, satiniert  
spot; acier, chrome / plastique, satiné

Ø 110



1x 5,4W

1x  
640lm



9 002759 956288



### 95631 SALTO

spot; steel, chrome / plastic, satiné  
Spot; Stahl, chrom / Kunststoff, satiniert  
spot; acier, chrome / plastique, satiné

L 560, B 130



3x 5,4W

3x  
640lm



9 002759 956318



### 95632 SALTO

spot; steel, chrome / plastic, satiné  
Spot; Stahl, chrom / Kunststoff, satiniert  
spot; acier, chrome / plastique, satiné

L 760, B 130



4x 5,4W

4x  
640lm



9 002759 956325



# CLIP & PLUG LUMINAIRES

KLEMM- & STECKERLEUCHTEN  
LUMINAIRES À PINCE & SUR PRISE

## LIGHT - VIRTUALLY ANYWHERE -

Our clamping and plug-in luminaires inspire with their flexible uses. They serve as pleasant reading lamps or can be positioned for targeted highlighting.

## LICHT - PRAKTISCH ÜBERALL -

Unsere Klemm- und Steckerleuchten begeistern durch ihre flexible Verwendbarkeit. Sie dienen als angenehme Lesebeleuchtung oder können zur gezielten Lichtsetzung positioniert werden.



## LA LUMIÈRE - PRATIQUE ET PARTOUT -

Nos luminaires à pinces et à fiches ravissent de leurs possibilités flexibles d'utilisation. Ils servent de lumière agréable pour la lecture ou peuvent être positionnés afin d'offrir une lumière ciblée.





# OVERVIEW

CLIP & PLUG LUMINAIRES



DAKAR 3  
p. 706



DAKAR 3  
p. 706



RICCIO 1  
p. 706



CABADO  
p. 707



MINI 4  
p. 708



MINI 4  
p. 708



MINI 4  
p. 708



TINEO  
p. 710



TINEO  
p. 710



TINEO  
p. 710



TINEO  
p. 711





92935



92932

LED



94329

LED

### 92935 DAKAR 3

plug light; steel, satin nickel, chrome / plastic, white  
Steckerleuchte; Stahl, nickel-matt, chrom / Kunststoff, weiss  
luminaire sur prise; acier, nickel mat, chrome / plastique, blanc

L 70, H 180, A 280



E14 1x 25W 4



9 002759 929350



### 92932 DAKAR 3

clamp light; plastic, steel, silver, chrome / plastic, white  
Klemmleuchte; Kunststoff, Stahl, silber, chrom / Kunststoff, weiss  
luminaire à pince; plastique, acier, argent, chrome / plastique, blanc

L 245, H 260



E14 1x 4W 1x 320lm 4



9 002759 929329



### 94329 RICCIO 1

clamp light; plastic, steel, white, chrome / steel, white, chrome  
Klemmleuchte; Kunststoff, Stahl, weiss, chrom / Stahl, weiss, chrom  
luminaire à pince; plastique, acier, blanc, chrome / acier, blanc, chrome

L 180, H 330



GU10 1x 3W 1x 240lm 4



9 002759 943295

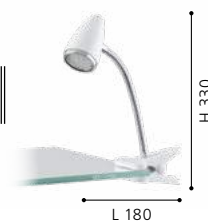



97077

LED

### 97077 CABADO

clamp light; plastic, white  
Klemmleuchte; Kunststoff, weiss  
luminaire à pince; plastique, blanc

L 120, B 65, H 420

LED

3 W

warm  
WHITE

80lm



ACCU

Li-ion



500mAh



9 002759 970772

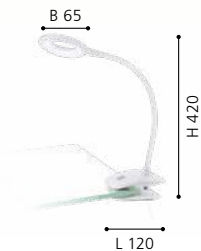



92925

LED



92924

LED

### 92925 MINI 4

plug light; steel, white, chrome  
Steckerleuchte; Stahl, weiss, chrom  
luminaire sur prise; acier, blanc, chrome

L 70, H 100

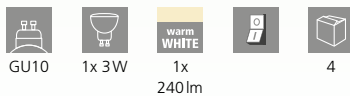

### 92924 MINI 4

plug light; steel, satin nickel, chrome  
Steckerleuchte; Stahl, nickel-matt, chrom  
luminaire sur prise; acier, nickel mat, chrome

L 70, H 100



### 92933 MINI 4

plug light; steel, satin nickel, chrome  
Steckerleuchte; Stahl, nickel-matt, chrom  
luminaire sur prise; acier, nickel mat, chrome

L 70, H 180, A 220





92933

LED





97933



97932



97935



### 97932 TINEO

plug light; plastic, white  
Steckerleuchte; Kunststoff, weiss  
luminaire sur prise; plastique, blanc

H 60, Ø 55



0,4W 2lm 10



H 60



9 002759 979324



Ø 55

### 97933 TINEO

plug light; plastic, white  
Steckerleuchte; Kunststoff, weiss  
luminaire sur prise; plastique, blanc

H 85, Ø 55



0,26W 3lm 10



H 85



9 002759 979331



Ø 55

### 97935 TINEO

plug light; plastic, white  
Steckerleuchte; Kunststoff, weiss  
luminaire sur prise; plastique, blanc

L 85, B 60, H 65



0,3W 5lm 10



9 002759 979355



B 60

L 85



### 97934

This luminaire is equipped with a voice sensor. If an acoustic signal reaches an intensity of 60 dB, the night light will switch on automatically.

Diese Leuchte ist mit einem Akustiksensoren ausgestattet. Bei einem akustischen Signal ab 60 dB schaltet sich das Nachtlicht automatisch ein.

Cette lumière est équipée d'un capteur acoustique. A un signal acoustique dès 60 dezi Bell, la lumière de nuit s'intervient automatiquement.



97934



### 97934 TINEO

plug light; plastic, white  
Steckerleuchte; Kunststoff, weiss  
luminaire sur prise; plastique, blanc

L 90, B 70, H 90



9 002759 979348



### 97932, 97933, 97934, 97935

Automatic illumination. This photo-electric lighting controller automatically switches light 'ON' at dusk and automatically 'OFF' again at dawn.

Automatische Beleuchtung. Der Day & Night Sensor schaltet bei Dämmerung automatisch Licht AN und am Morgen automatisch wieder AUS.

Éclairage automatique. L'interrupteur crépusculaire allume automatiquement la lumière au crépuscule et l'éteint automatiquement à l'aube.

# TABLE & FLOOR LUMINAIRES

TISCH- & STEHLEUCHTEN

LUMINAIRES DE TABLE & LAMPADAIRES

---

## WE LOVE LIGHT -

The range of table and floor luminaires is made up of many different styles and convinces with its diverse uses. The luminaires give your home a comfortable light mood and turn into chic living room accessories.

---

## WIR STEHEN AUF LICHT -

Das Sortiment der Tisch- und Stehleuchten setzt sich aus unterschiedlichen Stilen zusammen und überzeugt mit seinen vielseitigen Einsatzmöglichkeiten. Die Leuchten verleihen Ihrem Zuhause eine gemütliche Lichtstimmung und werden zum schicken Wohnraumaccessoire.

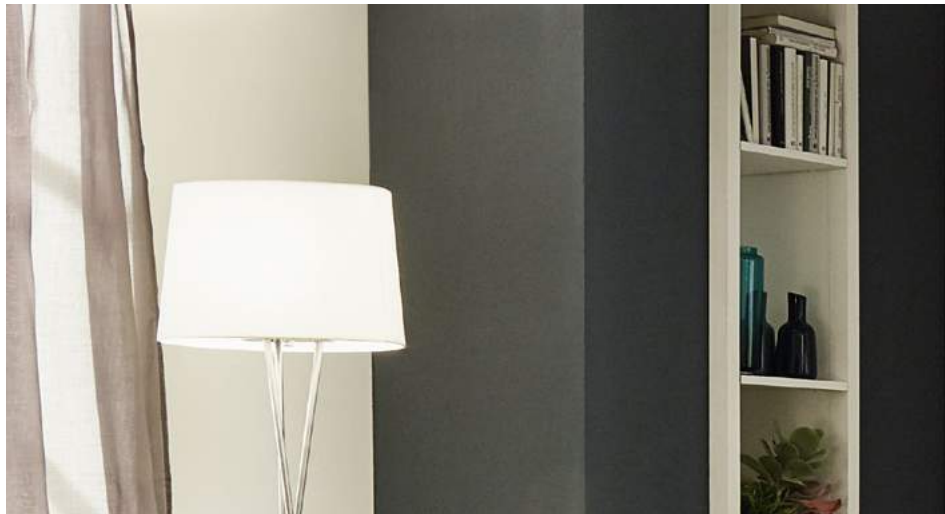

## NOUS NOUS TENONS EN PLEINE LUMIÈRE -

















































La gamme de luminaires de table et lampadaires est formée de différents styles et persuade par ses multiples possibilités d'application. Les lampes donnent à votre intérieur une lumière conviviale et se transforment en des accessoires d'habitat chics.

---



# OVERVIEW

## TABLE & FLOOR LUMINAIRES

 FONDACHELLI p. 716	 SCIGLIATI p. 716	 ESTAZIONA p. 717	 NOSINO p. 717	 CONESA p. 718	 SANTANDER p. 719	 ESPARTAL p. 719	 NADINA p. 719
 TERRIENTE p. 720	 REKALDE p. 720	 PICACHA p. 720	 CARBONERAS p. 721	 BUDENSEA p. 721	 BARBOTTO p. 722	 DARNIUS p. 722	 BORGILLO p. 723
 UP 2 p. 724-725	 BAYA LED p. 726-727	 SARRIONE p. 728	 BAYA p. 729	 VILLABATE 1 p. 730-731	 PASTERI p. 731	 PEDREGAL 1 p. 732	 CARLTON 2 p. 733
 CHIETINO 1 p. 734	 LIDSING p. 734	 MANALBA 1 p. 735	 MANALBA p. 735	 TRONDIO p. 736	 BELLARIVA 3 p. 736	 BELLARIVA p. 736-737	 MATARO 1 p. 738
 MATARO p. 738	 CAHUAMA p. 738-739	 SWARBY p. 740	 CERCAMAR p. 741	 PETTO 1 p. 741	 MAMBLAS p. 741	 AMEZAGA p. 742	 ERMUA p. 743
 CASTELLATO p. 743	 OLIVAL 1 p. 743	 SOLO 1 p. 744	 SOLO p. 745	 SLIM p. 745	 DAMASCO 1 p. 745, 746	 GEO p. 747	 NARANJO p. 749
 DESIERTO p. 749							



This product is available in different colors and shapes./ Dieser Artikel ist in unterschiedlichen Farben und Formen verfügbar.  
Cet article est disponible en différentes couleurs et formes.







**95539**



**95541**



**98391**

### 95539 FONDACHELLI

floor light; steel, satin nickel / fabric, white, silver  
 Stehleuchte; Stahl, nickel-matt / Textil, weiss, silber  
 lampadaire; acier, nickel mat / tissu, blanc, argent

H 1515, Ø 510



E27 1x 60W



9 002759 955397



H 1515



9 002759 955410

### 95541 FONDACHELLI

floor light; steel, black / fabric, black, copper  
 Stehleuchte; Stahl, schwarz / Textil, schwarz, kupfer  
 lampadaire; acier, noir / tissu, noir, cuivre

H 1515, Ø 510

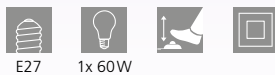

E27 1x 60W



H 1515



9 002759 983918

### 98391 SCIGLIATI

floor light; steel, black / fabric, black, gold  
 Stehleuchte; Stahl, schwarz / Textil, schwarz, gold  
 lampadaire; acier, noir / tissu, noir, or

H 1440, Ø 340, Base: Ø 645

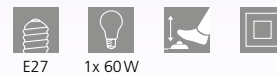

E27 1x 60W



H 1440



99015

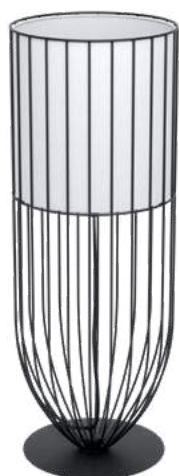

99101



99102

### 99015 ESTAZIONA

floor light; steel, black / fabric, black  
 Stehleuchte; Stahl, schwarz / Textil, schwarz  
 lampadaire; acier, noir / tissu, noir

L 260, B 235, H 1500, Base: Ø 245

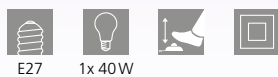

E27 1x 40W



9 002759 990152

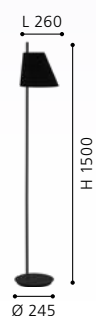

### 99101 NOSINO

table light; steel, black / fabric, white  
 Tischleuchte; Stahl, schwarz / Textil, weiss  
 luminaire de table; acier, noir / tissu, blanc

H 580, Ø 220, Base: Ø 220

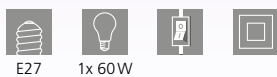

E27 1x 60W



9 002759 991012

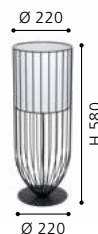

### 99102 NOSINO

floor light; steel, black / fabric, white  
 Stehleuchte; Stahl, schwarz / Textil, weiss  
 lampadaire; acier, noir / tissu, blanc

H 1310, Ø 250, Base: Ø 250



E27 1x 60W



9 002759 991029

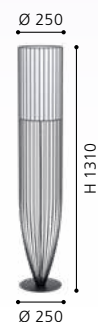



**95686**



**94946**

**LED**

**95686 CONESA**

floor light; steel, satin nickel / fabric, glass, white  
 Stehleuchte; Stahl, nickel-matt / Textil, Glas, weiss  
 lampadaire; acier, nickel mat / tissu, verre, blanc

H 1700, Ø 380, Base: Ø 230



E27



1x 60W



E14



1x 40W



9 002759 956868





## 98309

This luminaire can be switched separately with a pull switch.

Diese Leuchte ist separat mit Zugschalter schaltbar.

Ce luminaire peut être commuté séparément à l'aide d'un interrupteur à tirette.



98309

LED



92206

## 94946 SANTANDER

floor light; steel, satin nickel / fabric, white  
Stehleuchte; Stahl, nickel-matt / Textil, weiss  
lampadaire; acier, nickel mat / tissu, blanc

H 1530, Ø 500, Base: Ø 250



E27



1x 60W



1x 2,1W



1x  
250lm



9 002759 949464

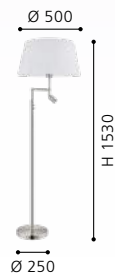

Ø 250

H 1530

## 98309 ESPARTAL

floor light; steel, aluminium, satin nickel, aluminium / fabric, white  
Stehleuchte; Stahl, Alu, nickel-matt, alu / Textil, weiss  
lampadaire; acier, aluminium, nickel mat, aluminium / tissu, blanc

H 1485, Ø 250, Base: Ø 250



E27



1x 60W



11,8W



1550lm



9 002759 983093



Ø 250

H 1485

## 92206 NADINA

floor light; steel, satin nickel / fabric with hoop-and-loop tape, white  
Stehleuchte; Stahl, nickel-matt / Textil mit Klettverschluss, weiss  
lampadaire; acier, nickel mat / tissu avec fermeture velcro, blanc

L 1790, B 380, H 1950, Base: Ø 320



E27



1x 60W



9 002759 922061



Ø 320

H 1950





98453

98453

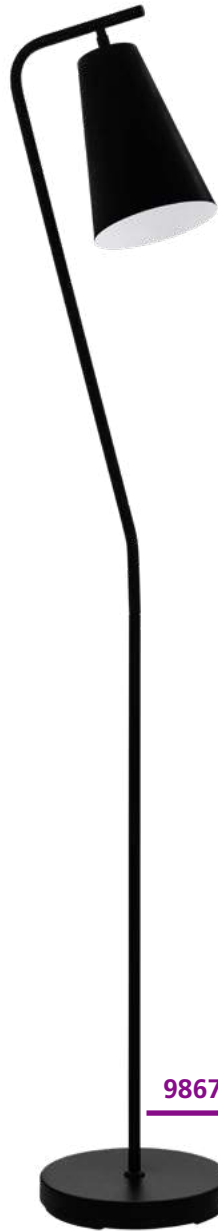

98674



99715

LED

### 98453 TERRIENTE

floor light; steel, black / glass vaporized, black-transparent  
 Stehleuchte; Stahl, schwarz / Glas bedampft, schwarz-transparent  
 lampadaire; acier, noir / verre vaporisé, noir transparent

H 1500, Base: Ø 260



E27 1x 40W



9 002759 984533

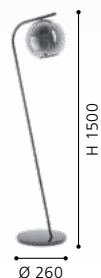

### 98674 REKALDE

floor light; steel, black, white  
 Stehleuchte; Stahl, schwarz, weiss  
 lampadaire; acier, noir, blanc

L 290, B 160, H 1500, Base: Ø 250



E27 1x 40W



9 002759 986742



### 99715 PICACHA

floor light; steel, black / plastic, white  
 Stehleuchte; Stahl, schwarz / Kunststoff, weiss  
 lampadaire; acier, noir / plastique, blanc

H 1625, Base: B 150, T 150



LED warm WHITE 25,7W 3600lm



9 002759 997151





99822

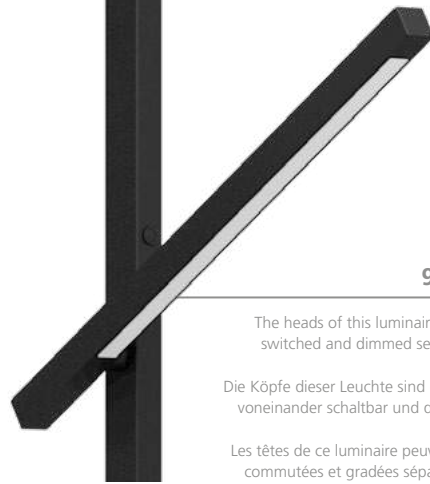

99882

The heads of this luminaire can be switched and dimmed separately.  
 Die Köpfe dieser Leuchte sind getrennt voneinander schaltbar und dimmbar.  
 Les têtes de ce luminaire peuvent être commutées et gradées séparément.



99113

This lamp is rotatable.  
 Diese Leuchte ist drehbar.  
 Cette lampe est rotative.

0-180°

0-80°



99113



**99822 CARBONERAS**

floor light; steel, black / plastic, transparent  
 Stehleuchte; Stahl, schwarz / Kunststoff, transparent  
 lampadaire; acier, noir / plastique, transparent

L 400, B 250, H 1800, Base: B 330, T 240

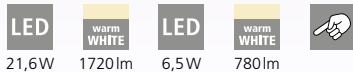

21,6W 1720lm 6,5W 780lm



9 002759 998226

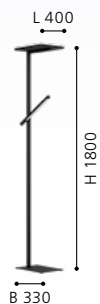

**99113 BUDENSEA**

floor light; cast aluminium, black, white  
 Stehleuchte; Aluguss, schwarz, weiss  
 lampadaire; fonte d'aluminium, noir, blanc

L 365, B 250, H 1800

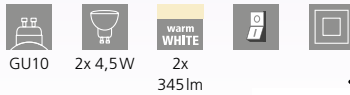

2x 345lm



9 002759 991135





97583

LED



97584

LED



98458

### 97583 BARBOTTO

table light; steel, black, gold  
Tischleuchte; Stahl, schwarz, gold  
luminaire de table; acier, noir, or

H 395, Ø 60, Base: Ø 100

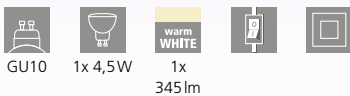

GU10 1x 4,5W 1x 345lm



9 002759 975838



### 97584 BARBOTTO

floor light; steel, black, gold  
Stehleuchte; Stahl, schwarz, gold  
lampadaire; acier, noir, or

H 1370, Ø 60, Base: Ø 185

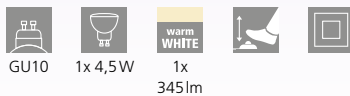

GU10 1x 4,5W 1x 345lm



9 002759 975845



### 98458 DARNIUS

floor light; steel, black, gold  
Stehleuchte; Stahl, schwarz, gold  
lampadaire; acier, noir, or

H 1420, Ø 380, Base: Ø 645



E27 1x 40W



9 002759 984588



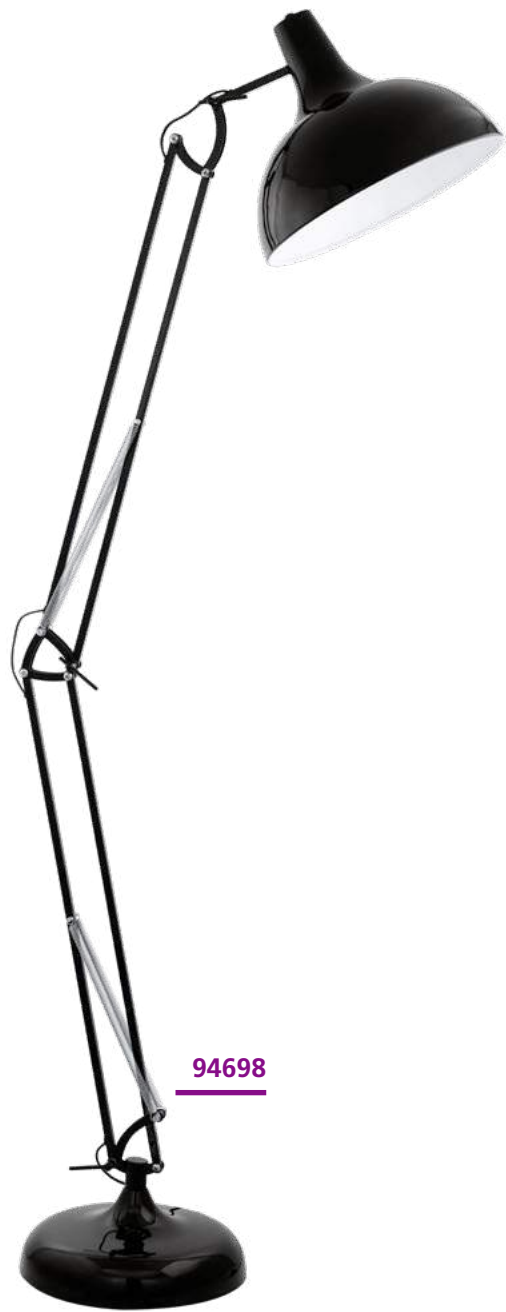

**94698**

**94698 BORGILLIO**

floor light; steel, black  
 Stehleuchte; Stahl, schwarz  
 lampadaire; acier, noir

L 380, H 1900, Base: Ø 340

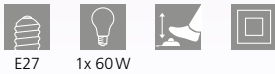

E27 1x 60W



9 002759 946982

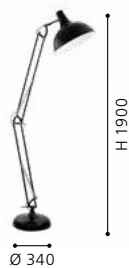

**94705**

**94705 BORGILLIO**

floor light; steel, copper  
 Stehleuchte; Stahl, kupfer  
 lampadaire; acier, cuivre

L 380, H 1900, Base: Ø 340

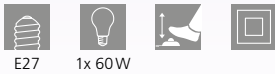

E27 1x 60W



9 002759 947057

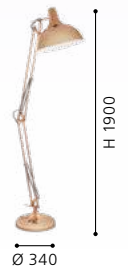



**93917**



**82842**



**82843**

### 93917 UP 2

floor light; steel, nickel-nero / plastic, glass, white  
 Stehleuchte; Stahl, nickel-nero / Kunststoff, Glas, weiss  
 lampadaire; acier, nickel noir / plastique, verre, blanc

H 1765, Ø 275, Base: Ø 230

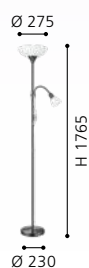
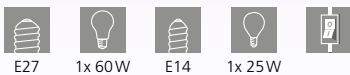

### 82842 UP 2

floor light; steel, satin nickel / plastic, glass, white  
 Stehleuchte; Stahl, nickel-matt / Kunststoff, Glas, weiss  
 lampadaire; acier, nickel mat / plastique, verre, blanc

H 1765, Ø 275, Base: Ø 230



### 82843 UP 2

floor light; steel, brass-matt / plastic, glass, white  
 Stehleuchte; Stahl, messing-matt / Kunststoff, Glas, weiss  
 lampadaire; acier, laiton mat / plastique, verre, blanc

H 1765, Ø 275, Base: Ø 230

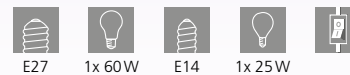





**82844**

DESIGN  
HIGHLIGHT  
DETAIL



**82844 UP 2**

floor light; steel, bronzed / plastic, glass, white  
 Stehleuchte; Stahl, brüniert / Kunststoff, Glas, weiss  
 lampadaire; acier, bruni / plastique, verre, blanc

H 1765, Ø 275, Base: Ø 230

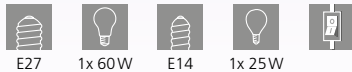



93877



93876



93875



### 93877 BAYA LED

floor light; steel, brass / glass, plastic, white, satiné  
 Stehleuchte; Stahl, messing / Glas, Kunststoff, weiss, satiniert  
 lampadaire; acier, laiton / verre, plastique, blanc, satiné

L 360, H 1800, Base: Ø 250

LED 20W warm WHITE 1950lm LED 2,5W warm WHITE 240lm LED 2,5W

warm WHITE 250lm



9 002759 938772

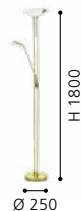

### 93876 BAYA LED

floor light; steel, bronzed / glass, plastic, white, satiné  
 Stehleuchte; Stahl, brüniert / Glas, Kunststoff, weiss, satiniert  
 lampadaire; acier, bruni / verre, plastique, blanc, satiné

L 360, H 1800, Base: Ø 250

LED 20W warm WHITE 1950lm LED 2,5W warm WHITE 240lm LED 2,5W

warm WHITE 250lm



9 002759 938765

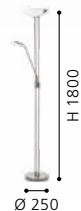

### 93875 BAYA LED

floor light; steel, chrome / glass, plastic, white, satiné  
 Stehleuchte; Stahl, chrom / Glas, Kunststoff, weiss, satiniert  
 lampadaire; acier, chrome / verre, plastique, blanc, satiné

L 360, H 1800, Base: Ø 250

LED 20W warm WHITE 1950lm LED 2,5W warm WHITE 240lm LED 2,5W

warm WHITE 250lm



9 002759 938758





DESIGN  
HIGHLIGHT  
DETAIL













93874

LED

### 93874 BAYA LED

floor light; steel, satin nickel / glass, plastic, white, satinated  
Stehleuchte; Stahl, nickel-matt / Glas, Kunststoff, weiss, satiniert  
lampadaire; acier, nickel mat / verre, plastique, blanc, satiné

L 360, H 1800, Base: Ø 250

- |  |   |   |  |   |
|--|---|---|--|---|
|  LED<br>20W             |  warm<br>WHITE<br>1950lm |  LED<br>2,5W |  warm<br>WHITE<br>240lm |  LED<br>2.5W |
|  warm<br>WHITE<br>250lm |                          |              |                         |              |

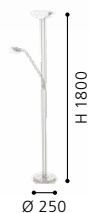



93713

LED

**93713 SARRIONE**

floor light; steel, satin nickel / plastic, satiné  
 Stehleuchte; Stahl, nickel-matt / Kunststoff, satiniert  
 lampadaire; acier, nickel mat / plastique, satiné

H 1800, Base: Ø 250

<b>LED</b>	<b>warm WHITE</b>	<b>LED</b>	<b>warm WHITE</b>	<b>LED</b>
17,3W	1600lm	2,9W	270lm	4.5W

<b>warm WHITE</b>				
440lm				







DESIGN  
HIGHLIGHT  
DETAIL



85974



85971

### 85974 BAYA

floor light; steel, bronzed / satin glass, white  
Stehleuchte; Stahl, brüniert / Glas satiniert, weiss  
lampadaire; acier, bruni / verre satiné, blanc

L 440, H 1800, Base: Ø 280



R75 1x 230W G9 1x 33W



9 002759 859749

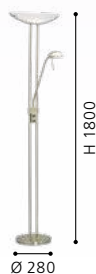

### 85971 BAYA

floor light; steel, satin nickel / satin glass, white  
Stehleuchte; Stahl, nickel-matt / Glas satiniert, weiss  
lampadaire; acier, nickel mat / verre satiné, blanc

L 440, H 1800, Base: Ø 280



R75 1x 230W G9 1x 33W



9 002759 859718







99103

DESIGN  
HIGHLIGHT  
DETAIL



### 99103 VILLABATE 1

table light; steel, black / fabric, black, white  
Tischleuchte; Stahl, schwarz / Textil, schwarz, weiss  
luminaire de table; acier, noir / tissu, noir, blanc

L 185, B 160, H 175



E27



1x 40W



9 002759 991036





**99104**



**95726**



**95725**

### 99104 VILLABATE 1

table light; steel, satin nickel / fabric, taupe  
Tischleuchte; Stahl, nickel-matt / Textil, taupe  
luminaire de table; acier, nickel mat / tissu, taupe

L 185, B 160, H 175

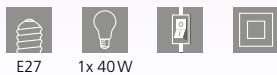

E27 1x 40W



9 002759 991043



### 95726 PASTERI

table light; steel, satin nickel / fabric, taupe  
Tischleuchte; Stahl, nickel-matt / Textil, taupe  
luminaire de table; acier, nickel mat / tissu, taupe

H 275, Ø 140, Base: Ø 120



E14 1x 40W



9 002759 957261



### 95725 PASTERI

table light; steel, satin nickel / fabric, white  
Tischleuchte; Stahl, nickel-matt / Textil, weiss  
luminaire de table; acier, nickel mat / tissu, blanc

H 275, Ø 140, Base: Ø 120



E14 1x 40W



9 002759 957254





95185

### 95185 PEDREGAL 1

table light; steel, copper / fabric, black, copper  
Tischleuchte; Stahl, kupfer / Textil, schwarz, kupfer  
luminaire de table; acier, cuivre / tissu, noir, cuivre

H 645, Ø 350



E27



1x 60W





95789



95787



95788

### 95789 CARLTON 2

table light; steel, black / fabric, white  
Tischleuchte; Stahl, schwarz / Textil, weiss  
luminaire de table; acier, noir / tissu, blanc

H 305, Ø 165

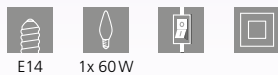

E14 1x 60W



9 002759 957896



### 95787 CARLTON 2

table light; steel, copper / fabric, black, copper  
Tischleuchte; Stahl, kupfer / Textil, schwarz, kupfer  
luminaire de table; acier, cuivre / tissu, noir, cuivre

H 305, Ø 165



E14 1x 60W



9 002759 957872



### 95788 CARLTON 2

table light; steel, brass / fabric, black, gold  
Tischleuchte; Stahl, messing / Textil, schwarz, gold  
luminaire de table; acier, laiton / tissu, noir, or

H 305, Ø 165

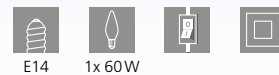

E14 1x 60W



9 002759 957889

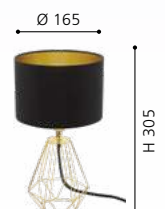





**97516**



**99289**



**97516 CHIETINO 1**

table light; wood, steel, natural, chrome / fabric, white  
 Tischleuchte; Holz, Stahl, natur, chrom / Textil, weiss  
 luminaire de table; bois, acier, nature, chrome / tissu, blanc

H 440, Ø 260, Base: B 235, T 235

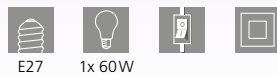

E27 1x 60W



**99289**

Deoration not included  
 in delivery.

Dekoration im Lieferumfang  
 nicht enthalten.

Décoration non incluse  
 dans la livraison.

**99289 LIDSING**

table light; steel, glass, chrome, clear / fabric, grey  
 Tischleuchte; Stahl, Glas, chrom, klar / Textil, grau  
 luminaire de table; acier, verre, chrome, clair / tissu, gris

H 480, Ø 240, Base: Ø 115

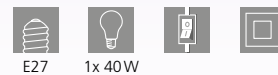

E27 1x 40W







99329



99331



95386

### 99329 MANALBA 1

table light; ceramic, silver / fabric, white, silver  
Tischleuchte; Keramik, silber / Textil, weiss, silber  
luminaire de table; céramique, argent / tissu, blanc, argent

H 300, Ø 200, Base: Ø 125

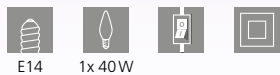

E14 1x 40W



9 002759 993290



### 99331 MANALBA 1

table light; ceramic, gold-coloured / fabric, black, gold  
Tischleuchte; Keramik, goldfarben / Textil, schwarz, gold  
luminaire de table; céramique, doré / tissu, noir, or

H 300, Ø 200, Base: Ø 125



E14 1x 40W



9 002759 993313



### 95386 MANALBA

table light; steel, gold / fabric, black, gold  
Tischleuchte; Stahl, gold / Textil, schwarz, gold  
luminaire de table; acier, or / tissu, noir, or

H 380, Ø 250



E27 1x 60W



9 002759 953867





**93046**



**99332**



**97773**

### 93046 TRONDIO

table light; ceramic, white / fabric, white  
Tischleuchte; Keramik, weiss / Textil, weiss  
luminaire de table; céramique, blanc / tissu, blanc

H 270, Ø 150, Base: Ø 120



E14 1x 40W



9 002759 930462



### 99332 BELLARIVA 3

table light; ceramic, white / fabric, linen, light brown  
Tischleuchte; Keramik, weiss / Textil, Leinen, hellbraun  
luminaire de table; céramique, blanc / tissu, lin, marron clair

H 360, Ø 200, Base: Ø 160

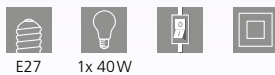

E27 1x 40W



9 002759 993320



### 97773 BELLARIVA

table light; ceramic, creme-white / fabric, white  
Tischleuchte; Keramik, creme-weiss / Textil, weiss  
luminaire de table; céramique, blanc crème / tissu, blanc

H 320, Ø 150, Base: Ø 120

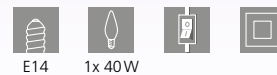

E14 1x 40W



9 002759 977733





**97774**

### 97774 BELLARIVA

table light; ceramic, grey / fabric, white  
Tischleuchte; Keramik, grau / Textil, weiss  
luminaire de table; céramique, gris / tissu, blanc

H 320, Ø 150, Base: Ø 120



E14



1x 40W



9 002759 977740



DESIGN  
HIGHLIGHT  
DETAIL



99333



93044



99825

### 99333 MATARO 1

table light; ceramic, black / fabric, white  
Tischleuchte; Keramik, schwarz / Textil, weiss  
luminaire de table; céramique, noir / tissu, blanc

L 130, B 110, H 300, Base: B 105, T 85



E14 1x 40W



9 002759 993337

### 93044 MATARO

table light; ceramic, grey / fabric, white  
Tischleuchte; Keramik, grau / Textil, weiss  
luminaire de table; céramique, gris / tissu, blanc

L 130, B 130, H 300, Base: B 105, T 85

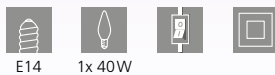

E14 1x 40W



9 002759 930448

### 99825 CAHUAMA

table light; ceramic, white, black / glass, grey matt  
Tischleuchte; Keramik, weiss, schwarz / Glas, grau matt  
luminaire de table; céramique, blanc, noir / verre, gris mat

H 300, Ø 275

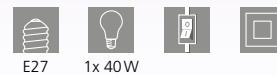

E27 1x 40W



9 002759 998257



99824

### 99824 CAHUAMA

table light; ceramic, light brown / glass, white

Tischleuchte; Keramik, hellbraun / Glas, weiss

luminaire de table; céramique, marron clair / verre, blanc

H 300, Ø 275



E27



1x 40W



9 002759 998240

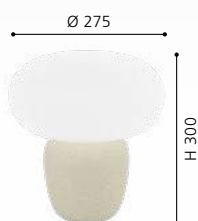

DESIGN  
HIGHLIGHT  
DETAIL





**98859**



**99084**

**98859 SWARBY**

table light; cement, grey  
Tischleuchte; Zement, grau  
luminaire de table; ciment, gris

H 120, Ø 100



E27



1x 60W



9 002759 988593





magnetic

94513

LED



98278

**99084 CERCAMAR**

table light; glass, clear  
Tischleuchte; Glas, klar  
luminaire de table; verre, clair

H 120, Ø 110

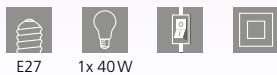

E27 1x 40W



9 002759 990848



**94513 PETTO 1**

table light; steel, white  
Tischleuchte; Stahl, weiss  
luminaire de table; acier, blanc

H 135, Ø 105, Base: Ø 90



GU10 1x 3W 1x 250lm



9 002759 945138



**98278 MAMBLAS**

table light; wood, steel, brown / plastic, white  
Tischleuchte; Holz, Stahl, braun / Kunststoff, weiss  
luminaire de table; bois, acier, marron / plastique, blanc

H 310, Ø 200, Base: Ø 105

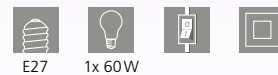

E27 1x 60W



9 002759 982782





**98864**

### 98864 AMEZAGA

table light; steel, black, brass

Tischleuchte; Stahl, schwarz, messing

luminaire de table; acier, noir, laiton

L 355, B 160, H 575, Base: Ø 170



E27



1x 10W



9 002759 988647





98837

LED



DESIGN  
HIGHLIGHT  
DETAIL

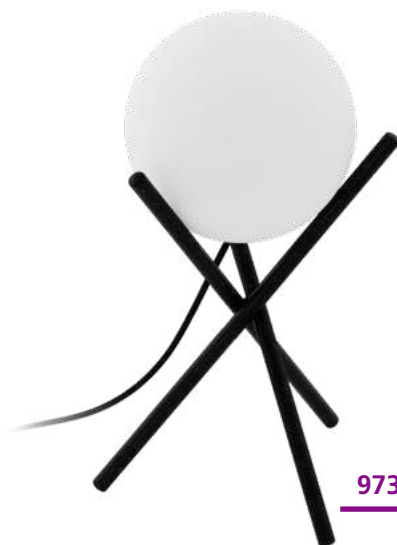

97333



97209

### 98837 ERMUA

table light; steel, wood, black, brown / plastic, white  
Tischleuchte; Stahl, Holz, schwarz, braun / Kunststoff, weiss  
luminaire de table; acier, bois, noir, marron / plastique, blanc

L 350, B 165, H 470, Base: B 240, T 160



4,5W 526lm



### 97333 CASTELLATO

table light; steel, black / glass opal-matt, white  
Tischleuchte; Stahl, schwarz / Glas opal-matt, weiss  
luminaire de table; acier, noir / verre opale mat, blanc

H 330, Ø 210

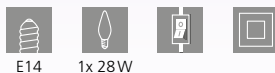

E14 1x 28W



### 97209 OLIVAL 1

table light; steel, black / smoked glass, black-transparent  
Tischleuchte; Stahl, schwarz / Rauchglas, schwarz-transparent  
luminaire de table; acier, noir / verre fumé, noir transparent

L 200, B 200, H 305

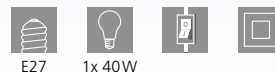

E27 1x 40W





**87254**



**87256**



**85104**

### 87254 SOLO 1

table light; steel, brass-matt / satin glass, white  
Tischleuchte; Stahl, messing-matt / Glas satiniert, weiss  
luminaire de table; acier, laiton mat / verre satiné, blanc

H 350, Ø 260, Base: Ø 130

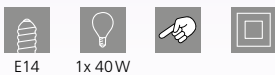

E14 1x 40W



9 002759 872540



### 87256 SOLO 1

table light; steel, wood, bronzed, nut / satin glass, white  
Tischleuchte; Stahl, Holz, brüniert, Nuss / Glas satiniert, weiss  
luminaire de table; acier, bois, bruni, noisette / verre satiné, blanc

H 350, Ø 260, Base: Ø 130

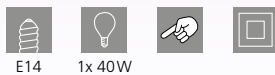

E14 1x 40W



9 002759 872564



### 85104 SOLO 1

table light; steel, satin nickel / satin glass, white  
Tischleuchte; Stahl, nickel-matt / Glas satiniert, weiss  
luminaire de table; acier, nickel mat / verre satiné, blanc

H 350, Ø 260, Base: Ø 130

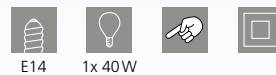

E14 1x 40W



9 002759 851040







**91238**



95785



**95785**



**82305**



82305

### 91238 SOLO

table light; steel, satin nickel / satin glass, white with decor  
Tischleuchte; Stahl, nickel-matt / Glas satiniert, weiss m.Dekor  
luminaire de table; acier, nickel mat / verre satiné, blanc avec décor

H 320, Ø 265, Base: Ø 130

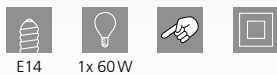

E14 1x 60W



9 002759 912383



### 95785 DAMASCO 1

table light; steel, satin nickel / glass opal-matt, white  
Tischleuchte; Stahl, nickel-matt / Glas opal-matt, weiss  
luminaire de table; acier, nickel mat / verre opale mat, blanc

H 300, Ø 145, Base: Ø 120



E14 1x 60W



9 002759 957858



### 82305 SLIM

table light; steel, satin nickel / glass, white  
Tischleuchte; Stahl, nickel-matt / Glas, weiss  
luminaire de table; acier, nickel mat / verre, blanc

H 220, Ø 70, Base: Ø 100

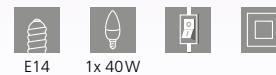

E14 1x 40W



9 002759 823054





95775 | 95776



95775



95776



98887

### 95775 DAMASCO 1

table light; steel, satin nickel / satin glass, white  
Tischleuchte; Stahl, nickel-matt / Glas satiniert, weiss  
luminaire de table; acier, nickel mat / verre satiné, blanc

H 215, Ø 100

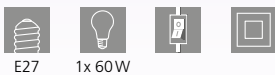

9 002759 957759



### 95776 DAMASCO 1

table light; steel, chrome / satin glass, white  
Tischleuchte; Stahl, chrom / Glas satiniert, weiss  
luminaire de table; acier, chrome / verre satiné, blanc

H 215, Ø 100

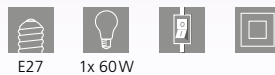

9 002759 957766



### 98887 DAMASCO 1

table light; steel, black / glass vaporized, black-transparent  
Tischleuchte; Stahl, schwarz / Glas bedampft, schwarz-transparent  
luminaire de table; acier, noir / verre vaporisé, noir transparent

H 310, Ø 100

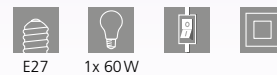

9 002759 988876

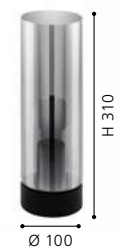



### 81827 GEO

table light; glass opal-matt, white  
Tischleuchte; Glas opal-matt, weiss  
luminaire de table; verre opale mat, blanc

H 200, Ø 100, Base: Ø 100

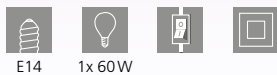

### 81828 GEO

table light; glass opal-matt, white  
Tischleuchte; Glas opal-matt, weiss  
luminaire de table; verre opale mat, blanc

H 350, Ø 120, Base: Ø 120

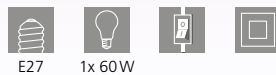

### 91242 GEO

table light; glass printed, white  
Tischleuchte; Glas bedruckt, weiss  
luminaire de table; verre imprimé, blanc

H 200, Ø 100

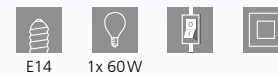



99597

LED



DESIGN  
HIGHLIGHT  
DETAIL



99794



**99597 NARANJO**

table light; steel, black / glass, clear  
Tischleuchte; Stahl, schwarz / Glas, klar  
luminaire de table; acier, noir / verre, clair

L 450, B 430, H 555



4x 4,1 W 1520lm



9 002759 995973

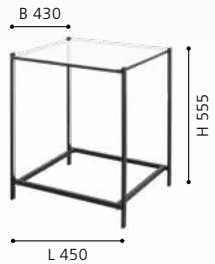

**99794 DESIERTO**

table light; steel, wood, black, brown  
Tischleuchte; Stahl, Holz, schwarz, braun  
luminaire de table; acier, bois, noir, marron

H 540, Ø 450



E27 1x 40W



9 002759 997946

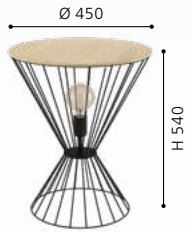



# OFFICE TABLE & FLOOR LUMINAIRES

BÜRO TISCH- & STEHLEUCHTEN

LUMINAIRES DE TABLE & LAMPADAIRES À BUREAU

---

## WE LOVE LIGHT -

The range of office table and floor luminaires is made up of many different styles and convinces with its diverse uses.

---

## WIR STEHEN AUF LICHT -

Das Sortiment der Büro Tisch- und Stehleuchten setzt sich aus unterschiedlichen Stilen zusammen und überzeugt mit seinen vielseitigen Einsatzmöglichkeiten.



## NOUS NOUS TENONS EN PLEINE LUMIÈRE -























































La gamme d'éclairages de table et sur pieds à bureau est formée de différents styles et persuade par ses multiples possibilités d'application.

---



# OVERVIEW

## OFFICE & TABLE LUMINAIRES

 <p>TRUNCA p. 754</p>	 <p>MASSERIE p. 754</p>	 <p>ARENAZA p. 755</p>	 <p>ARENAZA p. 755</p>	 <p>BANDERALO p. 756</p>	 <p>BANDERALO p. 756</p>	 <p>SELLANO p. 756</p>	 <p>LA SECA p. 757</p>
 <p>LA SECA p. 757</p>	 <p>CAUPO p. 758</p>	 <p>CAUPO p. 758</p>	 <p>COGNOLI p. 758</p>	 <p>COGNOLI p. 759</p>	 <p>LAROA p. 760</p>	 <p>LAROA p. 760</p>	 <p>LAROA p. 760</p>
 <p>LAROA p. 761</p>	 <p>LAROA p. 761</p>	 <p>LAROA p. 761</p>	 <p>CEPPINO p. 762</p>	 <p>CEPPINO p. 762</p>	 <p>VERADAL p. 762</p>	 <p>VERADAL p. 763</p>	 <p>DURENGO p. 764</p>
 <p>DAMBERA p. 764</p>	 <p>SNAPORA p. 764</p>	 <p>GEXO p. 766</p>	 <p>GEXO p. 766</p>	 <p>CABALES p. 766</p>	 <p>CABALES p. 767</p>	 <p>CABADO 1 p. 768</p>	 <p>CAJERO p. 768</p>
 <p>CAJERO p. 768</p>	 <p>CAJERO p. 769</p>	 <p>TABILLANO 1 p. 770</p>	 <p>TORONA 1 p. 770</p>	 <p>BORGILLIO p. 772</p>	 <p>BORGILLIO p. 772</p>	 <p>BORGILLIO p. 772</p>	 <p>BORGILLIO p. 773</p>
 <p>BANKER p. 774</p>	 <p>FIRMO p. 775</p>	 <p>FIRMO p. 775</p>	 <p>FIRMO p. 775</p>	 <p>BASIC 1 p. 776</p>	 <p>BASIC p. 776</p>	 <p>BASIC p. 776</p>	 <p>BASIC p. 777</p>
 <p>BASIC p. 777</p>	 <p>PRINCE 1 p. 778</p>	 <p>FOX 1 p. 778</p>	 <p>FOX p. 778</p>	 <p>FOX p. 779</p>	 <p>FABIO p. 779</p>	 <p>FABIO p. 779</p>	







**98093, 98247, 99828, 99829**

These luminaires have a Qi charging function. They can wirelessly charge Qi-compatible Smartphones by inductive energy transfer.

Diese Leuchten besitzen eine Qi-Ladefunktion. Damit können Qi-kompatible Smartphones über induktive Energieübertragung kabellos geladen werden.

Ces luminaires disposent d'une fonction de chargement Qi. Cela permet aux smartphones compatibles Qi d'être chargés sans fil par transmission d'énergie inductive.



**98093**

**LED**



**98247**

**LED**

### 98093 TRUNCA

table light; plastic, white  
Tischleuchte; Kunststoff, weiss  
luminaire de table; plastique, blanc

H 485, Base: B 185, T 185

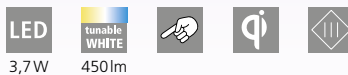

### 98247 MASSERIE

table light; plastic, white  
Tischleuchte; Kunststoff, weiss  
luminaire de table; plastique, blanc

H 385, Base: B 165, T 165

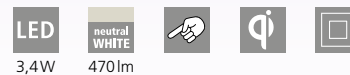





99828

LED



99829

LED



### 99828 ARENAZA

table light; steel, plastic, white, black  
Tischleuchte; Stahl, Kunststoff, weiss, schwarz  
luminaire de table; acier, plastique, blanc, noir

L 240, B 130, H 320, Base: B 240, T 120



9 002759 998288

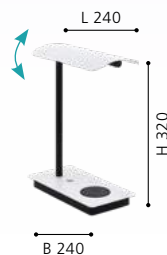

### 99829 ARENAZA

table light; steel, plastic, black  
Tischleuchte; Stahl, Kunststoff, schwarz  
luminaire de table; acier, plastique, noir

L 240, B 130, H 320, Base: B 240, T 120

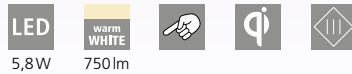

9 002759 998295





99831

LED

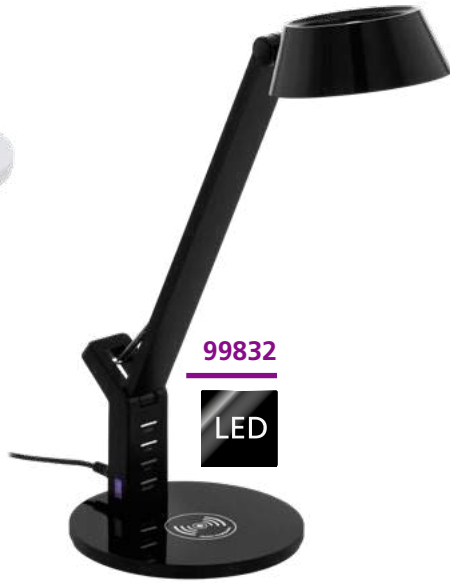

99832

LED



93901

The touch buttons can be used to dim the luminaire and adjust the light colour.

Über die Berührungsschalter kann man die Leuchte dimmen und die Lichtfarbe einstellen.

Les boutons tactiles peuvent être utilisés pour dimmer et régler la couleur de la lumière.



93901

LED

### 99831 BANDERALO

table light; plastic, white  
Tischleuchte; Kunststoff, weiss  
luminaire de table; plastique, blanc

L 295, B 170, H 405, Base: Ø 170

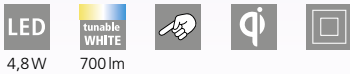

4,8W 700lm



9 002759 998318



### 99832 BANDERALO

table light; plastic, black  
Tischleuchte; Kunststoff, schwarz  
luminaire de table; plastique, noir

L 295, B 170, H 405, Base: Ø 170



4,8W 700lm



9 002759 998325



### 93901 SELLANO

table light; plastic, steel, white  
Tischleuchte; Kunststoff, Stahl, weiss  
luminaire de table; plastique, acier, blanc

H 430, Base: B 180, T 180



6W 630lm



9 002759 939014



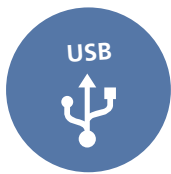

97044

LED

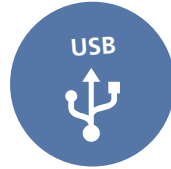

97045

LED



### 97044, 97045

These luminaires have a USB port for charging and operating the luminaires.

Diese Leuchten verfügen über einen USB-Anschluss, der zum Laden und Betrieb der Leuchten dient.

Faites fonctionner et charger ces luminaires grâce au port USB.

### 97044 LA SECA

table light; plastic, white  
Tischleuchte; Kunststoff, weiss  
luminaire de table; plastique, blanc

L 200, B 50, H 260, Base: B 70, T 50



1,8W



170lm



Li-ion



1200mAh



9 002759 970444

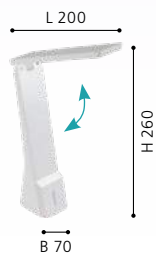

### 97045 LA SECA

table light; plastic, black  
Tischleuchte; Kunststoff, schwarz  
luminaire de table; plastique, noir

L 200, B 50, H 260, Base: B 70, T 50



1,8W



170lm



Li-ion



1200mAh



9 002759 970451



DESIGN  
HIGHLIGHT  
DETAIL



93966

LED



93965

LED



97915

LED

### 93966 CAUPO

table light; plastic, steel, black  
Tischleuchte; Kunststoff, Stahl, schwarz  
luminaire de table; plastique, acier, noir

L 260, H 320, Base: B 150, T 150

LED  
2,9W

tunable  
WHITE  
280lm



9 002759 939663

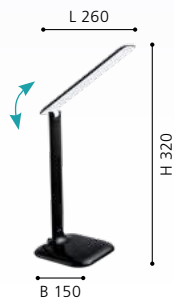

### 93965 CAUPO

table light; plastic, steel, white  
Tischleuchte; Kunststoff, Stahl, weiss  
luminaire de table; plastique, acier, blanc

L 260, H 320, Base: B 150, T 150

LED  
2,9W

tunable  
WHITE  
280lm



9 002759 939656



### 97915 COGNOLI

table light; plastic, white  
Tischleuchte; Kunststoff, weiss  
luminaire de table; plastique, blanc

L 70, B 100, H 510

LED  
3,2W

neutral  
WHITE  
300lm



9 002759 979157





97914

LED

### 97914 COGNOLI

table light; plastic, black  
 Tischleuchte; Kunststoff, schwarz  
 luminaire de table; plastique, noir

L 70, B 100, H 510

LED

3,2W

neutral  
 WHITE

300lm



9 002759 979140



DESIGN  
 HIGHLIGHT  
 DETAIL





### 96437 LAROA

clamp light; plastic, black  
 Klemmleuchte; Kunststoff, schwarz  
 luminaire à pince; plastique, noir

L 450, B 65, H 275



### 96434 LAROA

clamp light; plastic, white  
 Klemmleuchte; Kunststoff, weiss  
 luminaire à pince; plastique, blanc

L 450, B 65, H 275

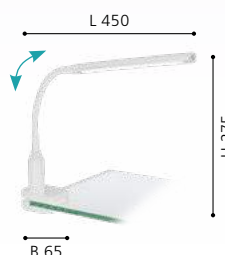

### 96438 LAROA

table light; plastic, black  
 Tischleuchte; Kunststoff, schwarz  
 luminaire de table; plastique, noir

L 480, B 120, H 325, Base: B 170, T 120





96435

LED

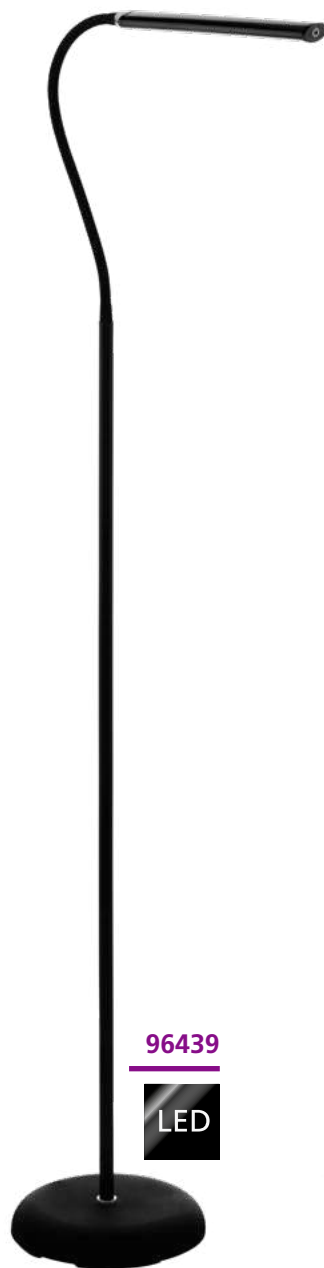

96439

LED



96436

LED

### 96435 LAROA

table light; plastic, white  
Tischleuchte; Kunststoff, weiss  
luminaire de table; plastique, blanc

L 480, B 120, H 325, Base: B 170, T 120



4,5W 550lm



9 002759 964351

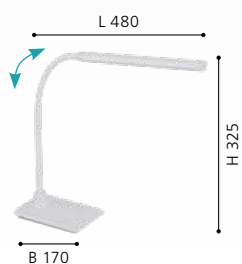

### 96439 LAROA

floor light; plastic, black  
Stehleuchte; Kunststoff, schwarz  
lampadaire; plastique, noir

L 535, B 215, H 1300, Base: Ø 210



4,5W 550lm



9 002759 964399

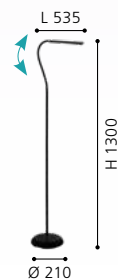

### 96436 LAROA

floor light; plastic, white  
Stehleuchte; Kunststoff, weiss  
lampadaire; plastique, blanc

L 535, B 215, H 1300, Base: Ø 210



4,5W 550lm



9 002759 964368



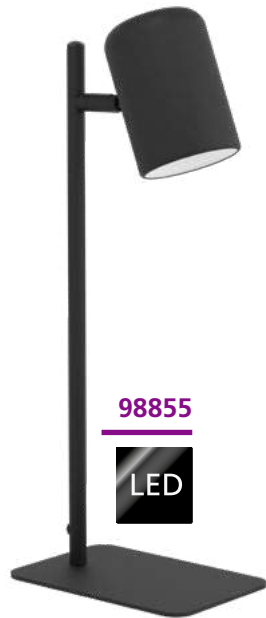

98855

LED

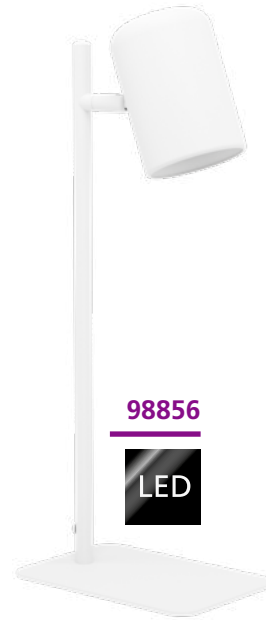

98856

LED

### 98855 CEPPINO

table light; steel, black, white  
Tischleuchte; Stahl, schwarz, weiss  
luminaire de table; acier, noir, blanc

H 380, Base: B 165, T 110

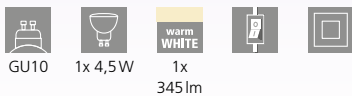

GU10 1x 4,5W 1x 345lm



### 98856 CEPPINO

table light; steel, white  
Tischleuchte; Stahl, weiss  
luminaire de table; acier, blanc

H 380, Base: B 165, T 110

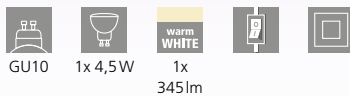

GU10 1x 4,5W 1x 345lm



### 98832 VERADAL

table light; wood, plastic, white, brown / steel, white  
Tischleuchte; Holz, Kunststoff, weiss, braun / Stahl, weiss  
luminaire de table; wood, plastic, blanc, marron / acier, blanc

B 125, H 420, Base: Ø 160

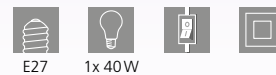

E27 1x 40W





98832



### 98831 VERADAL

table light; wood, plastic, black, brown / steel, black  
Tischleuchte; Holz, Kunststoff, schwarz, braun / Stahl, schwarz  
luminaire de table; wood, plastic, noir, marron / acier, noir

B 125, H 420, Base: Ø 160



E27



1x 40W



9 002759 988319



98831





93078

LED



94673

LED

### 93078 DURENGO

table light; plastic, steel, white, chrome  
Tischleuchte; Kunststoff, Stahl, weiss, chrom  
luminaire de table; plastique, acier, blanc, chrome

H 380, Ø 160, Base: Ø 160

LED

3W

warm  
WHITE

230lm



H 380

Ø 160



9 002759 930783

### 94673 DAMBERA

table light; plastic, black  
Tischleuchte; Kunststoff, schwarz  
luminaire de table; plastique, noir

H 375, Base: Ø 170

LED

4,5W

warm  
WHITE

520lm



H 375

Ø 170



9 002759 946739

### 94677 SNAPORA

table light; plastic, aluminium, black  
Tischleuchte; Kunststoff, Alu, schwarz  
luminaire de table; plastique, aluminium, noir

H 485, Base: Ø 110

LED

3,5W

warm  
WHITE

330lm



H 485

Ø 110



9 002759 946777





94677

LED



93076

LED



93077

LED



99334

LED

### 93076 GEXO

table light; plastic, steel, black, chrome  
Tischleuchte; Kunststoff, Stahl, schwarz, chrom  
luminaire de table; plastique, acier, noir, chrome

H 320, Ø 125, Base: Ø 125

LED

3W

warm  
WHITE

220lm



9 002759 930769

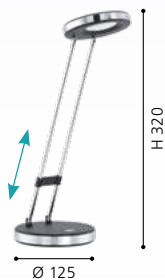

### 93077 GEXO

table light; plastic, steel, white, chrome  
Tischleuchte; Kunststoff, Stahl, weiss, chrom  
luminaire de table; plastique, acier, blanc, chrome

H 320, Ø 125, Base: Ø 125

LED

3W

warm  
WHITE

220lm



9 002759 930776

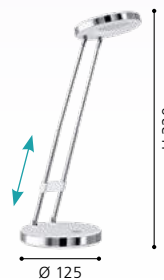

### 99334 CABALES

table light; plastic, white  
Tischleuchte; Kunststoff, weiss  
luminaire de table; plastique, blanc

H 340, Ø 140

LED

4,5W

warm  
WHITE

500lm



9 002759 993344





99335

LED

### 99335 CBALES

table light; plastic, black  
Tischleuchte; Kunststoff, schwarz  
luminaire de table; plastique, noir

H 340, Ø 140



4,5W 500lm





97078

This luminaire has a colored light in the base.  
 Diese Leuchte verfügt über ein farbiges Licht im Sockel.  
 Cette luminaire a une lumière colorée dans la base.



97078



95695



**97078 CABADO 1**

table light; plastic, white  
 Tischleuchte; Kunststoff, weiss  
 luminaire de table; plastique, blanc

L 140, B 110, H 490, Base: B 130, T 105

2,2W  
 300lm  
 0,3W  
 20lm  



**95695 CAJERO**

table light; plastic, white  
 Tischleuchte; Kunststoff, weiss  
 luminaire de table; plastique, blanc

L 150, B 100, H 500

4,5W  
 550lm  
  

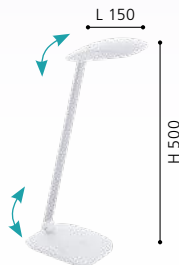

**95696 CAJERO**

table light; plastic, black  
 Tischleuchte; Kunststoff, schwarz  
 luminaire de table; plastique, noir

L 150, B 100, H 500

4,5W  
 550lm  
  

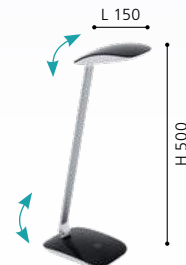



95696

LED



95694

LED

### 95694 CAJERO

table light; plastic, silver  
Tischleuchte; Kunststoff, silber  
luminaire de table; plastique, argent

L 150, B 100, H 500

LED

4,5W

neutral  
WHITE

550lm



9 002759 956943

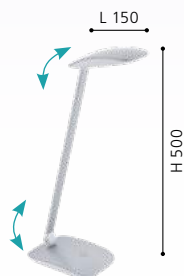





DESIGN  
HIGHLIGHT  
DETAIL



99019

### 99019 TABILLANO 1

table light; steel, black  
Tischleuchte; Stahl, schwarz  
luminaire de table; acier, noir

L 560, B 180, H 475, Base: Ø 180



E27 1x 40W



9 002759 990190



### 96957 TORONA 1

table light; steel, white / wood, natural  
Tischleuchte; Stahl, weiss / Holz, natur  
luminaire de table; acier, blanc / bois, nature

L 445, B 180, H 605, Base: Ø 180

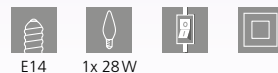

E14 1x 28W



9 002759 969578





96957





**94699**



**94702**

**94699 BORGILLIO**

table light; steel, white  
Tischleuchte; Stahl, weiss  
luminaire de table; acier, blanc

**94702 BORGILLIO**

table light; steel, chrome  
Tischleuchte; Stahl, chrom  
luminaire de table; acier, chrome

**94697 BORGILLIO**

table light; steel, black  
Tischleuchte; Stahl, schwarz  
luminaire de table; acier, noir

L 400, B 190, H 710, Base: Ø 190



E27 1x 40W



9 002759 946999

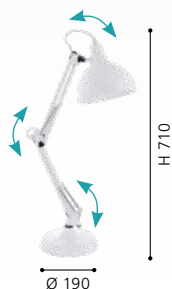

L 400, B 190, H 710, Base: Ø 190



E27 1x 40W



9 002759 947026



L 400, B 190, H 710, Base: Ø 190



E27 1x 40W



9 002759 946975





94697



94704

### 94704 BORGILLIO

table light; steel, copper  
Tischleuchte; Stahl, kupfer  
luminaire de table; acier, cuivre

L 400, B 190, H 710, Base: Ø 190



E27



1x 40W



9 002759 947040

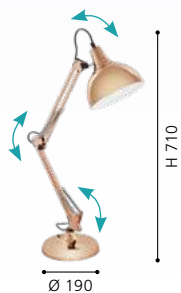



90967



90967

### 90967 BANKER

table light; steel, brass / glass painted, green  
Tischleuchte; Stahl, messing / Glas lackiert, grün  
luminaire de table; acier, laiton / verre laqué, vert

L 275, H 390



E27



1x 60W



9 002759 909673





## 90872, 90873, 90874

These luminaires come with a clip.

Diese Leuchten sind mit einer Klemme ausgestattet.

Ces luminaires viennent avec une pince fixation.



### 90872 FIRMO

table light; steel, plastic, shiny white

Tischleuchte; Stahl, Kunststoff, weiss glänzend

luminaire de table; acier, plastique, blanc brillant

L 730

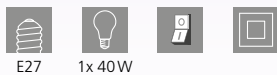

E27 1x 40W

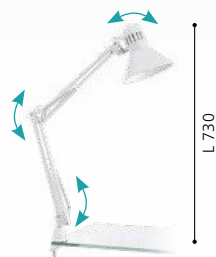

### 90873 FIRMO

table light; steel, plastic, shiny black

Tischleuchte; Stahl, Kunststoff, schwarz glänzend

luminaire de table; acier, plastique, noir brillant

L 730

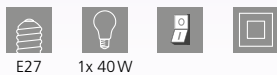

E27 1x 40W



### 90874 FIRMO

table light; steel, plastic, silver

Tischleuchte; Stahl, Kunststoff, silber

luminaire de table; acier, plastique, argent

L 730



E27 1x 40W

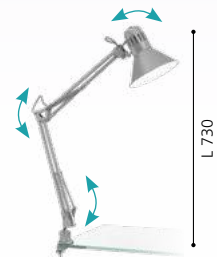



90977



9228



9229

### 90977 BASIC 1

table light; plastic, steel, silver  
Tischleuchte; Kunststoff, Stahl, silber  
luminaire de table; plastique, acier, argent

H 300, Base: Ø 125



E27 1x 40W



9 002759 909772



### 9228 BASIC

table light; plastic, steel, black  
Tischleuchte; Kunststoff, Stahl, schwarz  
luminaire de table; plastique, acier, noir

H 300, Base: Ø 125



E27 1x 40W



9 002759 922801



### 9229 BASIC

table light; plastic, steel, white  
Tischleuchte; Kunststoff, Stahl, weiss  
luminaire de table; plastique, acier, blanc

H 300, Base: Ø 125



E27 1x 40W



9 002759 922900





9230

9232

### 9230 BASIC

table light; plastic, steel, red  
 Tischleuchte; Kunststoff, Stahl, rot  
 luminaire de table; plastique, acier, rouge

### 9232 BASIC

table light; plastic, steel, blue  
 Tischleuchte; Kunststoff, Stahl, blau  
 luminaire de table; plastique, acier, bleu

H 300, Base: Ø 125



E27 1x 40W



9 002759 923006



H 300, Base: Ø 125



E27 1x 40W



9 002759 923204





86429



86955



92872

LED

### 86429 PRINCE 1

table light; steel, satin nickel / glass alabaster, white  
Tischleuchte; Stahl, nickel-matt / Glas alabaster, weiss  
luminaire de table; acier, nickel mat / verre albâtre, blanc

H 370, Base: Ø 125



E14 1x 25W



9 002759 864293



### 86955 FOX 1

table light; steel, satin nickel, chrome  
Tischleuchte; Stahl, nickel-matt, chrom  
luminaire de table; acier, nickel mat, chrome

H 330, Base: Ø 123

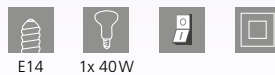

E14 1x 40W



9 002759 869557



### 92872 FOX

table light; steel, white, chrome  
Tischleuchte; Stahl, weiss, chrom  
luminaire de table; acier, blanc, chrome

H 320, Base: Ø 125



GU10 1x 3W  
warm  
WHITE  
1x  
240lm



9 002759 928728





**81262**



**92873**

**LED**



**81265**

**92873 FOX**

table light; steel, anthracite, chrome  
Tischleuchte; Stahl, anthrazit, chrom  
luminaire de table; acier, anthracite, chrome

H 320, Base: Ø 125



**81262 FABIO**

clamp light; steel, plastic, white, silver  
Klemmleuchte; Stahl, Kunststoff, weiss, silber  
luminaire à pince; acier, plastique, blanc, argent

H 300

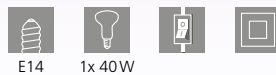

**81265 FABIO**

clamp light; steel, plastic, silver  
Klemmleuchte; Stahl, Kunststoff, silber  
luminaire à pince; acier, plastique, argent

H 300

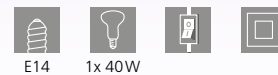



# CHILDREN LUMINAIRES

KINDERLEUCHTEN

LUMINAIRES POUR ENFANTS

## PLAY OF COLOUR -

The nursery luminaires are characterised by their playful and child-friendly designs. The lovely motives light up in many different colours and turn the nursery into a very special location.

## FARBENSPIEL -

Die Kinderzimmerleuchten zeichnen sich durch ihr verspieltes und kindgerechtes Design aus. Die liebevollen Motive erleuchten in unterschiedlichsten Farben und machen das Kinderzimmer zu einem besonderen Ort.



## JEU DE COULEUR -

Les éclairages de chambres d'enfants se distinguent de leur design joueur et adapté aux enfants. Les sujets formés avec amour sont illuminés dans des couleurs les plus variées et font de la chambre d'enfant un endroit spécial.





# OVERVIEW

CHILDREN LUMINAIRES



SAN CARLO  
p. 784



TABARA  
p. 784



JUNIOR 1  
p. 784



RUFFO  
p. 785



VIKI 1  
p. 785



VIKI 1  
p. 785





**97408**



**97667**



**87284**



### 97408 SAN CARLO

ceiling light; wood, steel, coloured  
Deckenleuchte; Holz, Stahl, bunt  
plafonnier; bois, acier, coloré

L 425, B 435, H 80



E27



3x 40W



9 002759 974084



L 425

### 97667 TABARA

ceiling light; wood, steel, green, white / satin glass, design "soccer"  
Deckenleuchte; Holz, Stahl, grün, weiss / Glas satiniert, Motiv Fussball  
plafonnier; bois, acier, vert, blanc / verre satiné, motif «football»

H 80, Ø 400



E27



1x 60W



9 002759 976675



Ø 400

### 87284 JUNIOR 1

wall / ceiling light; steel, white / satin glass, design "soccer"  
Wand- / Deckenleuchte; Stahl, weiss / Glas satiniert, Motiv Fussball  
applique / plafonnier; acier, blanc / verre satiné, motif «football»

Ø 245



E27



1x 60W



9 002759 872847



Ø 245





97575



97575

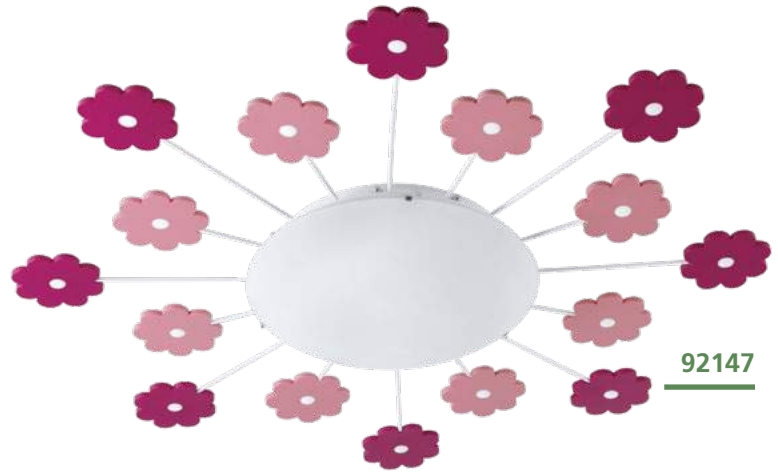

92147



92146

### 97575 RUFFO

ceiling light; steel, white / fabric, coloured  
Deckenleuchte; Stahl, weiss / Textil, bunt  
plafonnier; acier, blanc / tissu, coloré

H 110, Ø 380



E27 2x 40W

### 92146 VIKI 1

wall / ceiling light; steel, blue / satin glass, white  
Wand- / Deckenleuchte; Stahl, blau / Glas satiniert, weiss  
applique / plafonnier; acier, bleu / verre satiné, blanc

Ø 630, A 80



E27 1x 25W

### 92147 VIKI 1

wall / ceiling light; steel, pink / satin glass, white  
Wand- / Deckenleuchte; Stahl, pink / Glas satiniert, weiss  
applique / plafonnier; acier, rose / verre satiné, blanc

Ø 615, A 80



E27 1x 25W



9 002759 975753

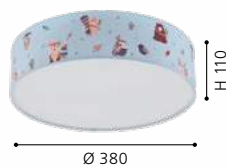

Ø 380



9 002759 921460

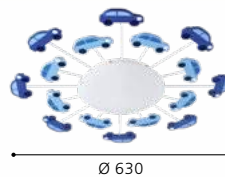

Ø 630



9 002759 921477

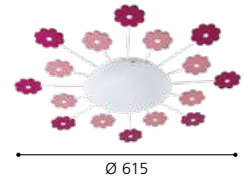

Ø 615

# KITCHEN & FUNCTIONAL LUMINAIRES

KÜCHEN- & FUNKTIONSLEUCHTEN

LUMINAIRES FONCTIONNELS & DE CUISINE

## YOUR KITCHEN FRIEND -

Our kitchen and function luminaires ensure the right lighting for your workplace and become true supporters. The practical and perfect fitted luminaires ideally refine your kitchen area.

## IHR KÜCHENFREUND -

Unsere Küchen- und Funktionsleuchten sorgen für die richtige Beleuchtung Ihrer Arbeitsfläche und werden zur wahren Alltagshilfe. Die praktischen Unterbauleuchten sind die perfekte Ergänzung für Ihren Küchenbereich.



## VOTRE AMI DE CUISINE -

Nos lumières fonctionnelles et de cuisine assurent le bon éclairage de votre surface de travail et deviennent une aide parfaite dans le quotidien. Les éclairages de meuble sont l'accompagnement parfait de votre espace de cuisine.

# OVERVIEW

KITCHEN & FUNCTIONAL LUMINAIRES



DUNDRY  
p. 788



DUNDRY  
p. 788



DUNDRY  
p. 788



DUNDRY  
p. 789



TEYA  
p. 790



KOB LED  
p. 791



KOB LED  
p. 791



BALIOLA  
p. 791

DESIGN  
HIGHLIGHT  
DETAIL



### 97572 DUNDRY

wall / ceiling light; plastic, white / plastic, white  
Wand- / Deckenleuchte; Kunststoff, weiss / Kunststoff, weiss  
applique / plafonnier; plastique, blanc / plastique, blanc

L 570, B 25, H 35



### 97573 DUNDRY

wall / ceiling light; plastic, white / plastic, white  
Wand- / Deckenleuchte; Kunststoff, weiss / Kunststoff, weiss  
applique / plafonnier; plastique, blanc / plastique, blanc

L 870, B 25, H 35



### 97574 DUNDRY

wall / ceiling light; plastic, white / plastic, white  
Wand- / Deckenleuchte; Kunststoff, weiss / Kunststoff, weiss  
applique / plafonnier; plastique, blanc / plastique, blanc

L 1170, B 25, H 35

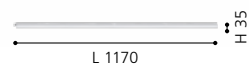





97571

LED

### 97571 DUNDRY

wall / ceiling light; plastic, white / plastic, white  
Wand- / Deckenleuchte; Kunststoff, weiss / Kunststoff, weiss  
applique / plafonnier; plastique, blanc / plastique, blanc

L 310, B 25, H 35



3,2W 440lm







96081



### 96081

Mounting type: incl. mounting clips  
Switch type: sensor switch (on/off)

Befestigungsart: inkl. Montageclips  
Schalterart: Sensor Schalter (ein/aus)

Type de fixation : clips de montage inclus  
Type de interrupteur : interrupteur capteur (on/off)

### 96081 TEYA

under cabinet light; aluminium, silver / plastic, white  
Unterbauleuchte; Alu, silber / Kunststoff, weiss  
éclairage de meuble; aluminium, argent / plastique, blanc

L 600, B 55, H 25

LED

8,1W

neutral  
WHITE

850lm



9 002759 960810





93707



93706



94686



3 m

94686

Incl. battery: yes  
 Inkl. sensor: yes  
 Switch type: on/off/auto  
 Mounting type: incl. adhesive tape  
 Moveable LED: no

Inkl. Batterie: ja  
 Inkl. Sensor: ja  
 Schalterart: ein/aus/auto  
 Befestigungsart: inkl. Klebeband  
 Bewegliche LED: nein

Piles incluses : oui  
 Capteur inclus : oui  
 Type de interrupteur : marche/arrêt/auto  
 Type de fixation : ruban adhésif inclus  
 LED réglable : non



**93707 KOB LED**

under cabinet light; steel, satin nickel  
 Unterbauleuchte; Stahl, nickel-matt  
 éclairage de meuble; acier, nickel mat

L 600, B 70, H 25



3x 2,3W 780lm



9 002759 937072



**93706 KOB LED**

under cabinet light; steel, white  
 Unterbauleuchte; Stahl, weiss  
 éclairage de meuble; acier, blanc

L 600, B 70, H 25



3x 2,3W 780lm



9 002759 937065



**94686 BALIOLA**

wall light; plastic, silver  
 Wandleuchte; Kunststoff, silber  
 applique; plastique, argent

L 180, H 46, A 27

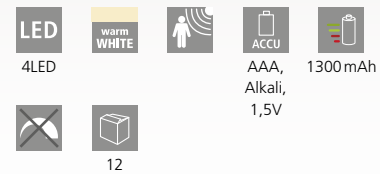

4LED

AAA, Alkali, 1,5V



12



9 002759 946869



# ACCESSORIES

ZUBEHÖR  
ACCESSOIRES

---

## MAKING IT SPECIAL -

Supplement your personal luminaire range with practical accessories and make your everyday life easier.

---

## DAS GEWISSE EXTRA -

Ergänzen Sie Ihr persönliches Leuchtersortiment mit praktischem Zubehör und erleichtern Sie sich somit Ihren Alltag.



## LE PETIT PLUS QUI COMPTE -

Accompagnez votre collection personnelle de lumières par des accessoires pratiques et facilitez-vous ainsi votre quotidien.

---

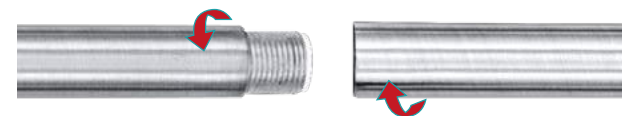
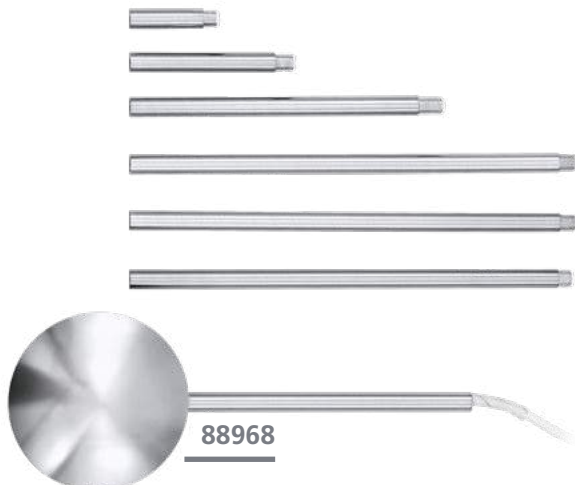
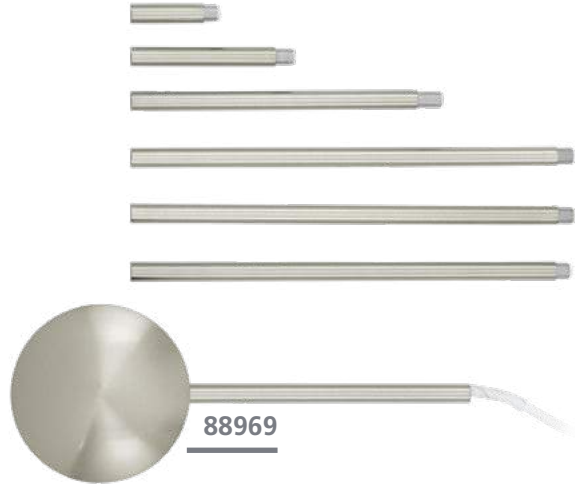

**88968, 88969, 92288**

Can be extended or shortened from 320 to 1570 mm by screwing in/off the single pieces.

Der Kabelkanal kann durch Ein-/Ausdrehen der Einzelstücke von 320 bis 1570 mm verlängert bzw. verkürzt werden.

Le conduit de câble peut être prolongé ou raccourci en visser/dévisser les pièces uniques de 320 à 1570 mm.

**92288 EXTENTION**

accessory; steel, white  
Zubehör; Stahl, weiss  
accessoire; acier, blanc

L 1570, B 120

**88969 EXTENTION**

accessory; steel, satin nickel  
Zubehör; Stahl, nickel-matt  
accessoire; acier, nickel mat

L 1570, B 120

**88968 EXTENTION**

accessory; steel, chrome  
Zubehör; Stahl, chrom  
accessoire; acier, chrome

L 1570, B 120

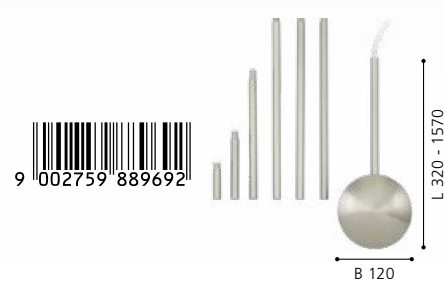
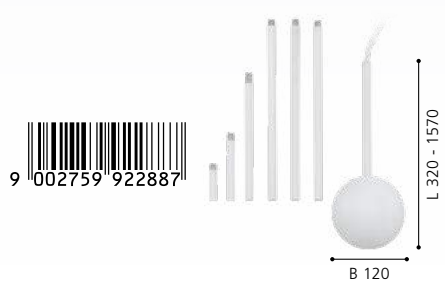



### 98277, 98279

Turns your single-light luminaire into a three-light one for brighter lighting!

Verwandelt Ihre einflammige Leuchte in eine dreiflammige Lichtquelle für hellere Beleuchtung!

Il transforme votre luminaire à une lumière en une source lumineuse à trois lumières pour un éclairage plus clair!



92348



98277



98279

### 92348

accessory; plastic, white  
Zubehör; Kunststoff, weiss  
accessoire; plastique, blanc

L 113, B 44, H 28



10



9 002759 923488



### 98277 RUEDA

accessory; plastic, white  
Zubehör; Kunststoff, weiss  
accessoire; plastique, blanc

H 75, Ø 190



E27 3x 20W



9 002759 982775



Ø 190

### 98279 RUEDA

accessory; plastic, black  
Zubehör; Kunststoff, schwarz  
accessoire; plastique, noir

H 75, Ø 190



E27 3x 20W



9 002759 982799



Ø 190





1



2



3

# ENERGY EFFICIENCY LABELS

ENERGIEEFFIZIENZ-LABEL

LABEL DE L'EFFICACITÉ ÉNERGÉTIQUE

## LED LUMINAIRES -

are increasingly popular and the demand for energy-efficient solutions is gaining strength. This has resulted in the adoption of several EU regulations prescribing the energy efficiency labelling of light sources and luminaires. We have prepared a brief overview of the new energy labels.

## LED LEUCHTMITTEL -

sind am Vormarsch, der Ruf nach energieeffizienten Lösungen wird immer größer. In den letzten Jahren wurden daher mehrere EU-Verordnungen verabschiedet, die die Kennzeichnung der Energieeffizienz bei Leuchtmitteln und Leuchten vorschreibt. Hier finden Sie eine kurze Übersicht der neuen Energie-effizienzkennzeichnung.



## LES ÉCLAIRAGES LED -

gagnent du terrain, la demande de solutions efficaces en énergie ne cesse de croître. C'est la raison pour laquelle plusieurs directives européennes prescrivant le marquage de l'efficacité énergétique des moyens d'éclairage et des lampes ont été promulguées au cours de ces dernières années. Vous trouverez ici un bref aperçu d'ensemble des nouveaux marquages de l'efficacité énergétique.

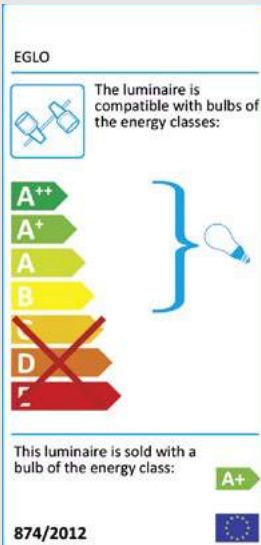

The information in brackets at the centre of the label indicates which bulbs may be used for the luminaire. In this case, the product is only compatible with bulbs with an energy efficiency rating of better than C.

Die Klammer in der Mitte des Labels gibt an, mit welchen Leuchtmitteln die Leuchte kompatibel ist. In diesem Fall dürfen nur Leuchtmittel verwendet werden, deren Energieklasse effizienter als C ist.

La parenthèse au milieu du label indique les moyens d'éclairage avec lesquels la lampe est compatible. Il est seulement permis dans ce cas d'utiliser des moyens d'éclairage dont la classe d'énergie présente une efficacité supérieure à C.

If bulbs are included with the luminaire, their energy classes are indicated at the bottom of the label.

Falls Leuchtmittel inkludiert sind, wird deren Energieklasse im unteren Teil des Labels angegeben.

Si des moyens d'éclairage sont inclus, leur classe énergétique est indiquée dans la partie inférieure du label.

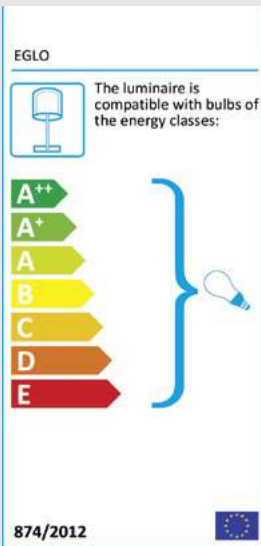

This label indicates that no bulbs are included with the luminaire. Consumers are free to choose their preferred bulb within the indicated energy classes.

Dieses Label wird verwendet, wenn die Leuchte ohne Leuchtmittel ausgeliefert wird. Der Kunde kann selber entscheiden, welches Leuchtmittel der angegebenen Klassen verwendet wird.

Ce label est utilisé lorsque la lampe est livrée sans ampoules. Le client peut décider lui-même quel ampoule des classes indiquées est utilisé.

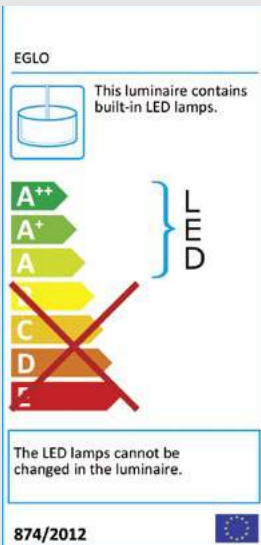

This label indicates that the luminaire is sold with built-in LED lamps that cannot be replaced by the consumer himself.

Dieses Label wird verwendet, wenn Leuchten mit LED-Modulen verkauft werden, die vom Endkunden nicht selbstständig ausgetauscht werden können.

Ce label est utilisé lorsque des lampes sont vendues avec des modules LED ne pouvant pas être changés par les clients finaux eux-mêmes.

## EEI BUTTONS

### bulbs included

inkl. Leuchtmittel | ampoules comprises



incl. highly efficient LED boards (cannot be replaced by the end consumer)

inkl. hocheffizienter LED Platinen (können nicht vom Endkonsumenten ausgetauscht werden)

incl. platines LED très efficaces (ne peuvent pas être remplacés par le consommateur final)



incl. highly efficient LED bulbs

inkl. hocheffizienter LED Leuchtmittel ampoules à LED plus efficaces comprises



incl. efficient LED and/or fluorescent bulbs

inkl. effizienter LED und/oder Leuchtstoff-Leuchtmittel

ampoules à LED et/ou fluorescentes efficaces comprises



incl. halogen bulbs

inkl. Halogen-Leuchtmittel

ampoules halogènes comprises

# GLASS ASSORTMENT

GLAS SORTIMENT

SORTIMENT DE VERRES

## SPECIAL GLASS -

on this page we would like to give you a detailed view on an assortment of glasses that are used with our luminaires.

## SPEZIAL GLAS -

Auf diesen Seiten möchten wir Ihnen einen detaillierten Blick auf ausgesuchte Gläser geben, welche wir für unsere Produkte verwenden.



## VERRES SPECIAL -

Sur cette page nous voulons vous donner un aperçu détaillé des verres choisis que nous utilisons pour notre produits.





# GLASS MATERIALS

GLAS-MATERIALIEN  
MATÉRIAUX DE VERRE



glass alabaster, white  
Glas alabaster, weiß  
verre albâtre, blanc



glass alabaster, champagne  
Glas alabaster, champagner  
verre albâtre, champagne



coating, black  
Beschichtung, schwarz  
revêtement, noir



glass wipe technique, champagner  
Glas Wischtechnik, champagner  
verre technique à l'essuyés, champagner



limed glass  
Glas gekalkt  
verre chaulé



crystal  
Kristall  
cristal

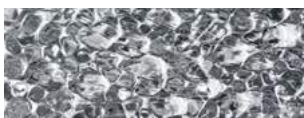

structured glass  
Glas mit Struktur  
verre structuré blanc



molten splinters of glass/crystal (granille)  
geschmolzene Splitter von Glas / Kristall  
(granille)  
éclats fondus de verre / cristal (granille)



structured glass, white printed decor  
strukturiertes Glas, weiß gedrucktes Dekor  
verre structuré, décor imprimé blanc



printed glass with decor  
bedrucktes Glas mit Dekor  
verre imprimé avec la décoration



glass painted, green  
Glas lackiert, grün  
verre laqué, vert



glass red-orange  
Glas rot-orange  
verre rouge-orange



smoked glass, black-transparent  
Rauchglas, schwarz-transparent  
verre fumé, noir transparent



glass vaporized, black-transparent  
Glas bedampft, schwarz-transparent  
verre vaporisé, noir transparent



glass vaporized, amber  
Glas bedampft, amber  
verre vaporisé, ambre



# EGLO WORLDWIDE

EGLO WELTWEIT

EGLO DANS LE MONDE



**HEADQUARTERS**  
EGLO LEUCHTEN GMBH  
Heiligkreuz 22  
A-6136 PILL  
T: +43 5242 6996 0 | F: +43 5242 6996 972  
E: info-austria@eglo.com



**CHILE - SANTIAGO**  
EGLO CHILE ILUMINACION LTDA.  
Av. Américo Vespucio 1930  
Conchalí - SANTIAGO DE CHILE  
T: +562 2 595 2222  
E: info-chile@eglo.com



**DENMARK**  
EGLO DANMARK A/S  
Agerbakken 20  
DK-8362 Hørring  
T: +45 70 22 55 11 | F: +45 70 22 55 21  
E: info-denmark@eglo.com



**AUSTRALIA**  
EGLO LIGHTING AUSTRALIA  
5/339 Archerfield Road  
Richlands | Queensland 4077  
T: +61 7 3375 1413 | F: +61 7 3375 1412  
E: info-australia@eglo.com



**CHINA**  
DONGGUAN EGLO CHINA LIGHTING CO., LTD.  
No.1 | Shangqiao Industrial Road | Shangqiao,  
Dongcheng District  
DONGGUAN CITY, GUANZHOU PROVINCE | CHINA  
T: +86 769 2203 3866 | F: +86 769 2203 6866  
E: info-china@eglo.com



**ESTONIA**  
MOODNE VALGUSTUS AS  
Rävala pst. 7  
EE-10143 TALLINN  
T: +372 667 6670 | F: +372 631 3195  
E: info-global@eglo.com



**BELGIUM**  
EGLO BELGIUM B.V.B.A.  
Antwerpssesteenweg 247 | B-2950 Kapellen  
Visit Address: Innovatiepark 20 |  
4906 AA OOSTERHOUT (NL)  
T: +32 3 250 60 80 | F: +32 3 219 80 67  
E: info-belgium@eglo.com



**COLOMBIA**  
EGLO COLOMBIA ILUMINACION SAS  
AUTOPISTA NORTE KM 19 COSTADO LOTE 30  
BOGOTÁ - CHIA  
T: +57 (1) 744 2339  
E: info-global@eglo.com



**FINLAND**  
EGLO FINLAND OY  
Malminraitti 17A  
00700 Helsinki  
T: +358 20 7649 820 | F: +358 20 7649 821  
E: info-finland@eglo.com



**BOSNIA-HERZEGOVINA**  
EGLO RASVJETA BH D.O.O.  
Ormanica bb  
BIH-76250 GRADACAC  
T: +387 35 86 85 00 | F: +387 35 82 44 41  
E: Info-Bosnia-Herzegovina@eglo.com



**COSTA RICA**  
EGLO Costa Rica, Centro Comercial Calle Real local #8  
Guachipilín de Escazú de la sucursal del BAC  
San Jose 800 metros al norte San Jose Costa Rica.  
T: +506-2289-4690, +506-2100-6384  
E: Info-CostaRica@eglo.com



**FRANCE**  
EGLO FRANCE LUMINAIRE SARL  
Z.A. Jeune Bois | 2 Rue de la Martinique  
F-68274 WITTENHEIM  
T: +33 389 6250 30 | F: +33 389 6250 49  
E: info-france@eglo.com



**BULGARIA**  
EGLO BULGARIA EOOD  
Main Road Burgas-Sofia, 5th kilometer,  
Building KACHIKA, 8000 BOURGAS, Bulgaria  
T: +359 56 960 403 | F: +359 56 53 05 95  
E: info-bulgaria@eglo.com



**CROATIA**  
EGLO RASVJETA D.O.O.  
Jadranska avenija 9  
HR-10020 Zagreb  
T: +385 1 379 40 62 | F: +385 1 379 41 04  
E: info-croatia@eglo.com



**GERMANY**  
EGLO LEUCHTEN HANDELS GMBH  
Kleinbahnstr. 35  
D-59759 ARNSBERG  
T: +49 2932 6269 0 | F: +49 2932 6269 39  
E: info-germany@eglo.com



**CANADA**  
EGLO CANADA INC.  
20700 Route Transcanadienne  
Baie-D'Urfé, Québec | H9X 4B7  
T: +1 514 457 5483 | F: +1 514 457 5487  
E: info-canada@eglo.com



**CZECH REPUBLIC**  
EGLO CZ+SK s.r.o.  
Náchodská 2479/63  
CZ-193 00 PRAHA 9 Horní Počernice  
T: +420 281 924 163 | F: +420 281 925 205  
E: info-czechrepublic@eglo.com



**GREECE**  
EGLO HELLAS A.E.  
Sykias 2 and parodos dekeleias  
ACHARNAI, GR-13679  
T: +30 210 240 77 10 | F: +30 210 800 23 63  
E: info-greece@eglo.com



**GREAT BRITAIN**  
**EGLO UK LTD.**  
 Unit 12 Cirrus Park, Lower Farm Road, Moulton Park  
 Industrial Estate, NORTHAMPTON NN3 6UR  
 T: +44 1604 790 986 | F: +44 1604 670 282  
 E: info-greatbritain@eglo.com



**MOROCCO**  
**EGLO AFRICA**  
 219 Bd Med Zerkoutni. Suite: 67  
 20330 CASABLANCA | Morocco  
 T: +212 522 98 80 25 / 05  
 E: info-global@eglo.com / info.africa@eglo.com



**SPAIN**  
**EGLO ESPANA ILUMINACION S.L.**  
 Avda. de Castilla 1 (Edf. Best Point) 2º-16A  
 San Fernando de Henares, E-28830 MADRID  
 T: +34 91 677 9044 | F: +34 91 677 0304  
 E: info-spain@eglo.com



**HUNGARY - PRODUCTION & LOGISTICS**  
**EGLO MAGYARORSZAG KFT.**  
 Fő út. 155  
 H-3060 PASZTO  
 T: + 36 32 560 050 | F: +36 32 560 040  
 E: info-hungary@eglo.com



**THE NETHERLANDS**  
**EGLO VERLICHTING NEDERLAND B.V.**  
 Innovatiepark 20  
 4906 AA OOSTERHOUT (NBR)  
 T: +31 162 48 28 30  
 E: info-nl@eglo.com



**SWEDEN**  
**EGLO SVERIGE AB**  
 Star Street 1  
 SE-512 50 SVENLJUNGA  
 T: +46 340 623 505 | F: +46 340 623 605  
 E: info-sweden@eglo.com



**INDIA**  
**EGLO INDIA PRIVATE LIMITED**  
 A-307 Ansal Chamber-1, 3 Bhikaji Cama Place,  
 New Delhi-110066  
 T: +91 981 108 2205 | T: +91 999 961 0450  
 E: info-india@eglo.com



**NORWAY**  
**MS Belysning AS**  
 Heiaveien 4  
 NO-1900 FETSUND  
 T: +47 63 888500 | F: +47 63 888501  
 E: info-norway@eglo.com



**SWITZERLAND**  
**EGLO SCHWEIZ AG**  
 Seetalstraße 142  
 CH-6032 EMMEN  
 T: +41 41 268 69 59 | F: +41 41 268 69 58  
 E: info-switzerland@eglo.com



**ITALY**  
**EGLO ITALIANA S.R.L.**  
 Via Giotto, 4  
 I-31021 MOGLIANO VENETO (TV)  
 T: +39 041 45 66 232/245/251 | F: +39 041 45 74 066/071  
 E: info-italy@eglo.com



**PERU**  
**EGLO PERU S.A.C**  
 Avda. Santa Cruz No. 458 Distrito de San Isidro  
 Provincia y Departamento Lima, San Isidro - Lima  
 T: +51 1 4212 158  
 E: info-peru@eglo.com



**TURKEY**  
**Eglo Aydınlatma İthalat İhracat Ltd. Şti.**  
 Eyüp Sultan Mah. Sekmen Cad. No:18/2  
 34855 SAMANDIRA, SANKANTEPE / İSTANBUL  
 T: +90 216 311 09 -02 / -03 / -04 | F: +90 216 311 09 -05  
 E: info-turkey@eglo.com



**KAZAKHSTAN**  
**EGLO KAZAKHSTAN LLP**  
 Office 72, 14<sup>th</sup> floor, Block 4A, Nurlı-Tau Business Centr,  
 Al-Farabi Avenue 7, 050059 Almaty, Kazakhstan  
 T: +7 727 293 25 20 | M: +7 701 031 00 00  
 E: info-kazakhstan@eglo.com



**POLAND**  
**EGLO POLSKA SP. Z.O.O.**  
 Ul. Pulawska 479  
 02-844 WARSZAWA  
 T: +48 22 644 57 55 | F: +48 22 644 89 82  
 E: info-poland@eglo.com



**USA**  
**EGLO USA, INC.**  
 3640 Royal South Parkway  
 ATLANTA, GEORGIA 30349  
 T: +1 404 477 5601 | F: +1 404 393 7053  
 E: info-usa@eglo.com



**KOSOVO**  
**EGLO KOSOVA LLC**  
 Luginisht e qytetit pn  
 20000 PRIZREN- KOSOVO  
 T: +377 44 2166 87 | Shop: +381 29 2442 84  
 E: info-kosovo@eglo.com



**PORTUGAL**  
**EGLO PORTUGAL ILUMINAÇÃO, LDA**  
 Rua Fonte Parada, 125  
 PT-4595-434 SEROA-PAÇOS DE FERREIRA  
 T: +351 255 890 000 | F: +351 255 892 346  
 E: info-portugal@eglo.com



**UKRAINE**  
**EGLO UKRAINE LTD**  
 bulv. Vatslav Havel 6/7A  
 UA-03680 KIEV  
 T: +38 044 463 98 41 | F: +38 044 468 84 67  
 E: info-ukraine@eglo.com



**LITHUANIA**  
**MOODNE VALGUSTUS AS**  
 Rāvala pst. 7  
 EE-10143 TALLINN  
 T: +370 652 49923 | T: +372 667 6670  
 E: info-lithuania@eglo.com



**ROMANIA**  
**EGLO ROMANIA PRODEXIM SRL.**  
 Str. Atomistilor nr. 1D  
 R-077125 MAGURELE - ILFOV - ROMANIA  
 T: +40 314 250 902 | F: +40 314 250 899  
 E: info-romania@eglo.com



**MAGYARORSZÁG – ÉRTÉKESÍTÉS**  
**EGLO LUX KFT.**  
 Fő út. 143/A  
 H-2120 DUNAKESZI  
 T: +36 27 341 353 | F: +36 27 341 409  
 E: info-hungary@eglo.com



**RUSSIA**  
**EGLO LIGHTING LLC**  
 Varshavskoe shosse 35 | Building 1  
 RU-117105 | MOSCOW  
 T: +7495 789 4311 | F: +7495 789 4312  
 E: info-russia@eglo.com



**MALAYSIA**  
**EGLO ASIA SDN BHD**  
 No. 13, Jalan Pelukis U1/46B, Temasya 18, Glenmarie,  
 40150 Shah Alam, Selangor Darul Ehsan, Malaysia  
 T: +6011 1050 2336 | F: +603 5567 9415  
 E: info-malaysia@eglo.com



**SERBIA**  
**EGLO RASVETA DOO**  
 Stefana Prvovenčanog 28  
 11000 BEOGRAD | SRBIJA  
 T: +381 11 3981 366 | F: +381 11 3981 389  
 E: info-serbia@eglo.com



**MEXICO**  
**EGLO MÉXICO ILUMINACIÓN S DE RL DE CV**  
 Prolongación Avenida López Mateos Sur N°3561,  
 Fraccionamiento Los Gavilanes.  
 C.P. 45645, Tlajomulco de Zúñiga, Jalisco, México  
 T: +52 33 3687 20 95 | E: info-mexico@eglo.com



**SLOVAKIA**  
**EGLO CZ+SK s.r.o**  
 Náchodská 2479/63  
 CZ-193 00 PRAHA 9 Horní Počernice  
 T: +421 313 211 551 | F: +421 313 211 556  
 E: info-slovakia@eglo.com



**MIDDLE EAST**  
**EGLO LIGHTING MIDDLE EAST FZE**  
 P.O. BOX 262073, LOB 6, OFFICE G18  
 JEBEL ALI, DUBAI, UAE  
 T: +97 148810080 | F: +97 148810081  
 E: info.me@eglo.com



**SLOVENIA**  
**EGLO RASVJETA D.O.O.**  
 Jadranska avenija 9  
 HR-10020 Zagreb  
 T: +386 158 093 18  
 E: info-slovenia@eglo.com

# HOW TO READ

## ERKLÄRUNG

## COMMENT LIRE

### DIMENSIONS DIMENSIONEN DIMENSIONS

all dimensions in mm | alle Größen in mm | toutes dimensions en mm

L = length | Länge | longueur

B = width | Breite | largeur

H = height | Höhe | hauteur

∅ = diameter | Durchmesser | diamètre

A = projection length | Ausladung | amplitude

ET = installation depth | Einbautiefe | profondeur utile

Base = base dimensions | Sockelmaße | dimensions de base

Attention! The dimensions relate solely to the sizes of the luminaire.  
Any air spaces that would be relevant for a safe operating of the lamp were not considered.

Achtung! Die Größen beziehen sich nur auf die Abmessungen der Leuchte. Etwaige Lufträume, die für einen sicheren Betrieb der Leuchte notwendig sind, werden nicht berücksichtigt.

Attention! Les dimensions se réfèrent à la taille de la lampe seulement. Espacements éventuels, que seraient importants pour une opération de la lampe sans danger, n'ont pas été considérés.

### BUTTONS BUTTONS BOUTONS

Colour Rendering Index | Farbwiedergabeindex | Indice de rendu de couleur de LED

**CRI**  
**>90**

p.557

Bulb included | Leuchtmittel inkludiert | ampoules inclus



Recessed Luminaire | Einbauleuchte | luminaire encastrable



Surface Luminaire | Aufbauleuchte | luminaire en saillie



99445 ALBARIZA	99446 ALBARIZA	99447 ALBARIZA
pendant light; steel, wood, black, brown / fabric, cappuccino, gold	pendant light; steel, wood, black, brown / fabric, cappuccino, gold	pendant light; steel, wood, black, brown / fabric, cappuccino, gold
Hängeleuchte; Stahl, Holz, schwarz, braun / Textil, cappuccino, gold	Hängeleuchte; Stahl, Holz, schwarz, braun / Textil, cappuccino, gold	Hängeleuchte; Stahl, Holz, schwarz, braun / Textil, cappuccino, gold
luminaire en suspension; acier, bois, noir, marron / tissu, cappuccino, or	luminaire en suspension; acier, bois, noir, marron / tissu, cappuccino, or	luminaire en suspension; acier, bois, noir, marron / tissu, cappuccino, or
H 1100, ∅ 160	L 895, H 160, H 1100	H 1500, ∅ 700
1x 40W	3x 40W	5x 40W
H 1100 ∅ 160	H 1100 L 895	H 1500 ∅ 700

LIGHTING FAMILIES / FABRIC  
**164**

ARTICLE NUMBER  
ARTIKELNUMMER  
NUMÉRO D'ARTICLE

SERIES NAME  
SERIENNAME  
NOM DE LA SÉRIE

DESCRIPTION  
BESCHREIBUNG  
DESCRIPTION

The product description is composed as follows:  
luminaire type; enclosure material, enclosure colour / glass or shade material, glass or shade colour

Die Produktbeschreibung setzt sich wie folgt zusammen:  
Leuchtenart; Gehäusematerial, Gehäusefarbe / Schirm- bzw. Glasmaterial, Schirm- bzw. Glasfarbe

La description du produit est composée comme suit:  
type de luminaire; matériel de boîtier, couleur de boîtier / matériel de verre ou abat-jour, couleur de verre ou abat-jour

SPARE PARTS  
ERSATZTEILE  
PARTS DE REMPLACEMENT

If spare parts for product are available they are marked on the photograph with their corresponding article number.

Wenn zu einem Produkt Ersatzteile vorhanden sind, werden diese in der Abbildung mit der entsprechenden Artikelnummer markiert.

Si un produit a des parts de remplacement, elles sont marquées avec le numéro d'article dans la photo.

PRODUCT / PRODUCT IN THE AMBIANCE  
PRODUKT / PRODUKTE IM AMBIENTE  
PRODUITS / PRODUITS DANS L'AMBIENCE

You can find the article number next to each product on the page and in the ambiance pictures.

Sie finden die Artikelnummer jedes Produktes neben der Abbildung auf der Seite und auf unseren Ambientebildern.

Vous pouvez trouver le numéro d'article à la page et à côté de chaque produit dans les images de l'ambiance.

BUTTONS  
BUTTONS  
BOUTONS

Forest Stewardship Council®



p.8-9

PICTOGRAMMES  
PIKTOGRAMME  
PICTOGRAMMES

Technical details are represented as pictograms. An overview over all pictograms can be found on the next pages.

Technische Details werden als Piktogramme dargestellt. Eine Übersicht über alle Piktogramme finden Sie auf den nächsten Seiten.

Les détails techniques sont représentés sous forme de pictogrammes. Vous trouverez un aperçu de tous les pictogrammes dans les pages suivantes.

SKETCHES  
SKIZZEN  
CROQUIS

The sketches state the most meaningful dimensions. If a product is adjustable by will, a turquoise arrow marks this function and only the maximum dimensions are indicated.

Die Bemaßung der Skizzen umfasst jeweils die aussagekräftigsten Größen. Bei verstellbaren Produkten kennzeichnet ein türkiser Pfeil diese Funktion und nur die maximalen Größen werden angegeben.



















Les dimensions des croquis comprennent les plus représentatives. Si un produit est réglable au choix, une flèche turquoise affiche cette fonction et rien que les dimensions maximales sont indiquées.









































# PICTOGRAM

## PIKTOGRAMME PICTOGRAMME

### SOCKETS / FASSUNGEN / DOUILLES

 LED	 G4	 G53
 2G7	 G5	 GU5,3 / MR16
 2G11	 G9	 GU10
 2GX13	 G10Q	 GX53
 E14	 G13	 GY6,35
 E27	 G23	 R7s

### BULBS / LEUCHTMITTEL / AMPOULES

 E14 / C35	 E27 / A60 Halogen	 E27 / E140 Filament
 E14 / C35f	 E27 / R63 Halogen	 E27 / PS160 Filament
 E14 / D45	 E27 / A60 LED	 E27 / T30 Filament
 E14 / C35f LED	 E27 / A60 Filament	 E27 / T32 Filament
 E14 / D45 Halogen	 E27 / A65 LED	 G4 / T9
 E14 / C35 Halogen	 E27 / A75 Filament	 G4 / LT9
 E14 / T22	 E27 / G45 LED	 G4 / LT14
 E14 / C35 Filament	 E27 / G45 Filament	 G9
 E14 / C37 Filament	 E27 / G80 Filament	 G9 LED
 E14 / C35f Filament	 E27 / G95	 GU10
 E14 / C37f Filament	 E27 / G95 Filament	 GU10 LED
 E14 / P45 LED	 E27 / G125	 GU10 SMD LED
 E14 / P45 Filament	 E27 / G95 LED	 GX53 / LF75
 E14 / P50	 E27 / G200 Filament	<b>LED</b> LED board / LED Platine / LED bord
 E14 / ST48 Filament	 E27 / R63 LED	 MR16
 E14 / ST64 Filament	 E27 / ST48 Filament	 MR16 LED
 E14 / T20 LED	 E27 / ST64 Filament	 R7s / 78mm
 E27 / A60	 E27 / B80 Filament	 R7s / 118mm
 E27 / G90	 E27 / BR150 Filament	 R7s / 78mm LED
 E27 / QR63	 E27 / DP165 Filament	 R7s / 118mm LED



**LIGHT COLOUR & LUMEN / LICHTFARBE & LUMEN / COULEUR LUMINEUX & LUMEN**

The colours of the LED are represented as pictogrammes (see below), their luminous flux directly beneath. The luminous flux is quoted in lumen and describes the amount of light generated by the LED. The higher the value, the brighter is the lamp. Lumens are LED boards and are the light measurement value in bulbs.

Die Farben der LED werden als Piktogramm (siehe unten) dargestellt, deren Lichtstrom direkt darunter. Der Lichtstrom wird in Lumen gemessen und gibt die erzeugte Lichtmenge der LED an. Je höher der Wert, desto heller das Produkt. Lichtstromangaben (Lumen) sind Platinen- bzw. Leuchtmittelwerte.

Les couleurs de LED ont représentés sous forme de pictogrammes, leur flux lumineux directement en dessous. L'unité de flux lumineux est le lumen et il mesure la quantité de lumière générée par les LED. Plus la valeur est élevée, plus la lampe est lumineuse. Les lumens sont l'unité de mesure de l'intensité lumineuse des ampoules et des panneaux led intégrés.

	RGB RGB RGB		RGB + neutralwhite RGB + neutralweiß RGB + blanc neutral		cold white kaltweiß blanc froid
	RGB + white RGB + weiß RGB + blanc		RGB + tunabel white RGB + tunabel white RGB + tunabel white		neutral white neutralweiß blanc neutre
	RGB + warmwhite RGB + warmweiß RGB + blanc chaud		tunable white tunable white tunable white		
	RGB + coldwhite RGB + kaltweiß RGB + blanc froid		warm white warmweiß blanc chaud		

**SWITCHES & SENSORES / SCHALTER & SENSOREN / INTERRUPTEUR & CAPTEURS**

	incl. cable & plug inkl. Kabel & Stecker câble & connecteur inclus		pedal switch Trittschalter interrupteur à pied		swedish plug Stecker Schweden connecteur swede
	internal dimmer eingebauter Dimmer variateur intégré		cable switch Kabelschalter interrupteur à câble		"Touch me" ON/OFF "Touch me" EIN/AUS "Touch me" ON/OFF
	button switch Druckknopf interrupteur de pression		incl. cable & plug transformer inkl. Kabel & Stecktransformator câble & transformateur à prise		"Touch me" ON/OFF & dimm "Touch me" EIN/AUS & Dimmen "Touch me" ON/OFF & graduable
	function switch Funktionsschalter interrupteur fonction		remote control Fernbedienung télécommande		pull switch Zugschalter interrupteur à bascule
	rocker switch Wippschalter interrupteur à bascule		Day & Night Sensor Tag & Nacht Sensor sensor jour & nuit		Timer - automatic on/off Zeitschaltuhr - automatisches Ein- & Ausschalten minuterie - peut être éteint et allumé automatiquement
	pedal dimmer Trittdimmer variateur à pied		sensor Sensor sensor		

**FUNKTIONS & COMFORT / FUNKTIONEN & KOMFORT / FONCTIONS & CONFORT**

	incl. battery inkl. Akku incl. pile		cutout (in mm) Ausschnitt (in mm) perçage du panneau (en mm)		packaging / delivery unit Verpackungs- / Liefereinheit unité d'emballage / de livraison
	incl. battery inkl. Batterie incl. pile		dimmable with external dimmer dimbar mit externen Dimmer gradable avec un gradateur externe		shortable kürzbar réductible
	battery specifications Batteriespezifikationen spécifications des piles		not dimmable nicht dimmbar ne pas graduable		Voltage Volt Voltage
	beam angle Ausstrahlwinkel angle de rayonnement		Can be operated via control unit Bedienbar über Steuergerät Peut être commandé par une unité de contrôle		Watt
	corner mount possible Eckmontage möglich montage en coin possible		replaceable LED austauschbare LED LED remplaçables		USB connection USB-Anschluss Connexion USB
	Colour Rendering Index		loadable in kg belastbar in kg chargeable en kg		Qi-Charger

**PROTECTION CLASS / SCHUTZKLASSE / CLASSE DE PROTECTION**

The protection class indicates to what extent the lamp is protected against electric shock. All lamps in this catalogue are at least protected with the protection class 1 - a higher class is specified in the information box of the respective lamp.

Die Schutzklasse gibt an, inwiefern ein Produkt gegen einen elektrischen Schlag gesichert ist. Alle Leuchten in diesem Katalog sind mit mindestens Schutzklasse 1 gesichert, bei höheren Klassen wird das Symbol im Infokasten der Leuchte angegeben.

La classe de protection indique, dans quelle mesure la lampe est protégée contre les chocs électriques. Tous les lampes dans ce catalogue sont protégés au moins avec la classe 1 - une classe plus élevée est indiquée dans l'information de la lampe.

	protection class 1: protective earthing Schutzklasse 1: Schutzerdung classe de protection 1: prise de terre		protection class 2: protective insulation Schutzklasse 2: Schutzisolierung classe de protection 2: double isolation ou renforcée		protection class 3: protective low voltage Schutzklasse 3: Schutzkleinspannung classe de protection 3: très basse tension de sécurité
--	---	--	--	--	---

**PROTECTION RATING / SCHUTZGRAD / INDICE DE PROTECTION**

The protection rating ensures the operational safety of luminaires. The first number specifies the extent of the protection against the ingress of foreign bodies; the second number identifies the humidity protection grade. All luminaires in this catalogue are at least protected with the rating IP20 - a higher rating is specified in the information box of the luminaire.

Der Schutzgrad gewährleistet die Betriebssicherheit von Leuchten. Die erste Ziffer des IP Grades beschreibt den Schutzzumfang gegen das Eindringen von Fremdkörpern; die zweite Ziffer informiert über den Grad des Feuchtigkeitsschutzes. Alle Leuchten in diesem Katalog sind mit mindestens Schutzgrad IP20 gesichert, bei höheren Graden wird das Symbol im Infokasten der Leuchte angegeben.

L'indice de protection assure la sécurité opérationnelle des luminaires. Le premier chiffre indique à quel point la protection est efficace contre l'insertion de corps étrangers; le second chiffre indique quant à lui le degré de protection par rapport à l'humidité. Tous les luminaires dans ce catalogue sont protégés au moins avec l'indice IP20 - un indice plus élevé est indiqué dans l'information d'article.

	IP33		IP44		IP54		IP65		IP67
--	------	--	------	--	------	--	------	--	------

# REGISTER

SERIES NAMES

SERIENNAMEN

NOME DE PRODUITS

NAME NAME NOM	PAGE SEITE PAGE	NAME NAME NOM	PAGE SEITE PAGE	NAME NAME NOM	PAGE SEITE PAGE
ABREOSA	212	BANKER	774	BOLSANO	338-339
ACCESS REMOTE	82	BARBOTTO	722	BONARES 1	230-231
ACOLLA	458	BARI 1	605	BORGILLO	723, 772-773
ACOLLA 1	458	BARI-M	570	BOYAL	202-205
ALAMEDILLA	278	BARNHAM	664-665	BRENDA	401-402, 404
ALBANY	407	BASIC	776-777	BUDENSEA	721
ALBARACCIN	330-331	BASIC 1	776	BUENAVISTA	612
ALBARIZA	164	BASILANO	308-309	BUENAVISTA 1	614
ALEANDRO 1	338	BASILANO 1	306-307	BUENAVISTA 2	614-615
ALESSANDRA	407	BASURTU	443	BUTRANO	369
ALMEIDA	169	BATALLAS	628-629	BUZZ-LED	692-693
ALMEIDA 1	168	BATISTA 3	261	CABADO	707
ALMEIDA 2	166-167	BAYA	729	CABADO 1	768
ALMERA	521	BAYA LED	726-727	CABALES	766-767
ALMONTE	562	BAYMAN	259	CABO	448
ALOBRASE	319-321	BELATEGI	533	CABO 1	698
ALTAFLOR	418-420	BELESER	232-233	CABUS	582
ALVEZ	409	BELLARIVA	736-737	CADAQUES	322
AMADORA	260	BELLARIVA 3	736	CADAQUES 1	322
AMEZAGA	742	BELSIANA	434	CADEGAL	546-547
AMEZOLA	558	BELSIANA 1	435	CAHUAMA	738-739
AMONTILLADO	364, 424	BENARIBA	486	CAILIN	602
ARENAZA	755	BERREGAS	636	CAJERO	768-769
ARISCANI	324-325	BIMEDA	668-671	CALMANERA	380-381
AZBARREN	206	BITACHITO	358	CALNOVA	590
BALIOLA	791	BOCADELLA	354	CAMACHO	200-201
BANDERALO	756	BOCADELLA 1	432	CAMARGO	362
BANDERILLAS	278-279	BOGOTENILLO	366	CAMASTRA	387

NAME NAME NOM	PAGE SEITE PAGE	NAME NAME NOM	PAGE SEITE PAGE	NAME NAME NOM	PAGE SEITE PAGE
CAMBULOS	364	COGOLETO	489	DURENGO	764
CAMINALES-Z	26	COLTI	522	EGIDONELLA	276-277
CAMPANIA	522	COMPETA 1	488-490	ELGVERO	545
CAMPILO	392	COMPETA 2	488	ELIZONDO	542
CANICOSA 2	462	CONCESSA 1	162-163	ELLA	502
CANTALLOPS	387	CONDRADA 1	446	ENALURI	346
CANTERRAS	210-211	CONESA	718	ENCINITOS	379, 435
CAPASSO	492	CONESSA	344-345	ENEA	662-663
CAPASSO 1	487	CONNECT Z	21	ERMUA	365, 743
CAPASSO-Z	35	CONNECT-Z SENSOR	21	ERSEKA	226-227
CARBONERAS	721	CONSACA	638	ERVIDEL	268-269
CARDILLIO 1	700-701	CORBERA	684	ESCANDIDOS	222-223
CARDITO	459	CORETTO	335	ESPARTAL	719
CARDITO 1	340	CORREDERA	366	ESTAZIONA	717
CARLTON 2	733	CORTADERAS	218-219	ESTEPERRA	136, 139, 631
CAROVIGNO	644	CORTENOVA	350-351	ESTEVAU	371
CARPENTO	310	COSSANO	184, 186-187	EXTENTION	793
CARTAMA	347	COSSANO 2	188	FABIO	779
CARTIGNANO	528	COSWARTH	642	FALICETTO	542
CASIBARE	214-215, 640	CREMELLA	216-217	FARSALA	327
CASTELLATO	743	CURASAO	378	FEDRA 2	341
CASTRALVO	396	DAKAR 1	660-661	FELONICHE	535
CAUPO	758	DAKAR 3	706	FIRMO	775
CEPPINO	762	DAMASCO 1	745-746	FLORESTA	376
CERASELLA	333	DAMBERA	764	FONDACHELLI	716
CERCAMAR	741	DARNIUS	722	FOX	778-779
CHIETINO 1	734	DAVIDA	676-677	FOX 1	778
CIGLIE	527	DAVIDA 1	678-679	FRADELO	454-456
CIVITATE	529	DESIERTO	749	FRADELO 1	452-453
CLEMENTE	228-229	DIAMOND	341	FRAIOLI-Z	30-31
CODRIALES	367	DUNDRY	788-789	FRANIA	472-473, 476-477, 570-571
COGNOLI	758-759	DURELO	503	FRANIA-A	86-87

NAME NAME NOM	PAGE SEITE PAGE	NAME NAME NOM	PAGE SEITE PAGE	NAME NAME NOM	PAGE SEITE PAGE
FRANIA-S	474-475, 478-479	LABARETU	431	LOSALOMAS	382
FUERTECUSA	459	LAGUNITAS	332	LUBERIO	342
FUEVA 5	576, 578, 606-611	LANCIANO	484-485	MACCACARI	534
FUEVA-A	92	LANCIANO 1	484	MAGITTA 1	514
FUEVA-Z	48-59	LANCIANO-Z	34	MAGNUM LED	695
GAETANO 1	398, 400, 402-403	LAPELA	295	MAGNUM-LED	694-695
GALDAKAO	526	LAROA	760-761	MALVA	520
GASCUERIA	542	LASANA	286, 552	MAMBLAS	741
GATUELA	360-361	LASANA 1	285-287	MANALBA	735
GATUELA 1	360	LASANA 2	284-285, 287	MANALBA 1	735
GEO	747	LASANA 3	282-283	MANILVA 1	571
GERBERA 1	522	LAURITO	496	MANIZALES	357
GEXO	766	LAZOLO	404	MANTUNALLE	238-239
GIRON	470	LEBALIO	318	MANTUNALLE 1	236-237
GIRON-S	471	LED CARPI	574-575	MARSALES	142, 144
GITA 2	588	LED LORA	573	MARBELLA	266-267
GOROSIBA	234-235	LED PALERMO	573	MARGHERA-Z	24-25
GOROSIBA 1	234	LED PLANET	504	MARGITTA 1	510-511
GRADOLI	356	LED STRIPE-Z	64-65	MARINELLO	425
GRADOLI 1	357	LED-STRIPE-A	94	MARINELLO 1	424
GRAFIK	516	LEGANES	501	MAROJALES	445
GRIMALDINO		LEJIAS	280-281	MARONDA	170
GROMOLA	422	LIBERTAD	198-199	MARS	512-513, 518
GURARE	530	LIDSING	734	MARS 1	512-514
HERRORA-Z	40	LM_LED_E14	66, 96	MASERLO	146-147, 152-154, 156-161
IMPERIAL	520	LM_LED_E27	66, 68-77, 96-98	MASERLO 1	149-150
IPLITTO	422	LM_LED_GU10	67, 98-99	MASERLO 2	146, 154, 157, 160
ISIDRO	270-271	LOBATIA	359	MASETA	374-375
JUAREZA-Z	29	LOCANDA	672	MASIANO 1	450-451
JUNIOR 1	784	LOMALTAS-Z	28	MASSERIE	754
KOB LED	791	LONCINO 1	337	MATARO	738
LA SECA	757	LORD 2	406	MATARO 1	738

NAME NAME NOM	PAGE SEITE PAGE	NAME NAME NOM	PAGE SEITE PAGE	NAME NAME NOM	PAGE SEITE PAGE
MENDIETA	430	NERINI	461	PAUSIA	290
MENTALURGIA	500	NEVADO	293	PAWEDO 1	698
MESTRE	520-521	NIEVES	492-493	PEDREGAL 1	732
METRASS	548	NOCITO	666-667	PEDRISTELLA	551
METRASS 1	550-551	NOSINO	717	PENJAMO	499
METRASS 2	549	NOVAFELTRIA	300-301	PERPIGO	363
MEZZANA	354	NUVANO	398-399	PERTINI	294
MINI 4	708	OBREGON	393	PESCAITO	494
MIOGLIA 1	344	OILELLA	316-317	PETTO 1	741
MIRLAS	426	OKINZURI	371	PHIANEROS	274
MIRTAZZA	370	OLIVAL 1	743	PICACHA	720
MOGANO	440	ONO 2	533	PINTO	254-255
MOGANO 1	400	OPTICA	240, 242-243	PINTO GOLD	252-253
MONGODIO 1	544	PALBIETA	272-273	PINTO NERO	250
MONIROTE	419, 421	PALERMO 2	491	PINTO TEXTIL	248-249
MONO	604-605	PALMERA	602	PITALE	460
MONTEBALDO	358, 436	PALMITAL	566	PLANET	504
MONTEFINO	348	PALOMARO	464-466	PLANET 1	506-509
MONTEFIO	404	PALOMARO 1	464-466	POLLICA	634
MONTEFIO 1	342-343	PALOZZA	298-299	POSADERRA	112-114
MONTENOVO	463	PALOZZA 1	296	POZONDON	463
MORATICA - A	87	PANDELLA 1	596-599	POZUETA	353
MOSIANO	566	PANDELLA 2	596, 600	PRINCE 1	778
MULEGES	377	PASCAL 1	521	RAMON	386
MURCIA	262-263	PASSA	538-541	RAYA	514
MURMILLO	326	PASSA RELLA	430	RAZONI	372-373
MUSARA	431	PASSANO 1	436	REDUCTA 2	501
MUSURITA	494-495	PASTERI	108-111, 116-131, 731	REKALDE	720
NADINA	719	PASTERI SQUARE	112-114	REMIDOS	547
NARANJO	749	PASTORE	468	REMOTE 2.0	21
NARICES	220-221	PASTORE 1	468	RICCIO 1	706
NEMO	516	PASTORE 2	469	RICONTO 1	510



NAME NAME NOM	PAGE SEITE PAGE	NAME NAME NOM	PAGE SEITE PAGE	NAME NAME NOM	PAGE SEITE PAGE
RIVATO	258-259	SANTANDER	719	SPADAFORA	364, 424
ROCAMAR	334, 336	SARABIA	403	STAITI	436-437
ROCAMAR 1	335-336	SARGINTO	552-553	STAITI 1	524
ROCCAFORTE	388-391	SARRIA	680-683	STELLATO 1	176-177
ROLIMARE	422	SARRIONE	728	STELLATO 2	178-179
ROMAGNESE	338	SARSINA -A	88	STELLATO 3	180-181
ROMAO	106-107	SAVATARILA -Z	36-37	STICKER	603
ROMAO 1	106	SAVOY	264-265	SWARBY	740
ROMAO 3	107	SCALEA 1	512	TABARA	784
ROMENDO 1	580-581	SCIGLIATI	716	TABIAGO	224
RONCADE	289, 296	SEGEZIA	385	TABIANO	593
RONCADE 1	288	SELLANO	756	TABIANO-Z	29
RONDO	244-245	SELUCI	496-497	TABILLANO	648
ROTTELO	690-691	SELVINA	290-291	TABILLANO 1	524, 770
ROVIRA	361	SELVINA 1	288	TAMARA 1	560-561
ROVITO-Z	60-63	SELVINO	328-329	TAMURIA	428
RUEDA	794	SENDERO	190-191	TARANDELL	295
RUFFO	785	SERAS	656-657	TAREGA	208
RUIDERA	481	SERAS 1	654-655	TAZZOLI	530
SABINAR	394-395	SERAS 2	658-659	TERRIENTE	720
SALICETO-Z	27	SIDERNO	584	TEYA	790
SALITERAS -Z	37	SILENTINA	438-439	TINDARI	323
SALITRE	367	SILERAS	480-481	TINDORI	182-183
SALOBRENA -A	90-91	SILERAS -A	85	TINEO	710-711
SALOBRENA -Z	44-47	SILERAS -Z	35	TOLORICO	564
SALOME	518-519	SILVARES	209	TOMBOLO	170
SALTO	702-703	SIMOLARIS -Z	22-23	TORONA 1	770
SAMBATELLO	646-647	SLIM	745	TORONJA	501
SAN CARLO	784	SNAPORA	764	TORRETTA	591
SAN PERI	524	SOLO	745	TORRONTES	322
SANIA 4	536-537	SOLO 1	744	TOTARI -Z	32-33
SANIA 5	584-585	SORRENTA 1	461	TOWNSHEND 3	620-623

NAME NAME NOM	PAGE SEITE PAGE	NAME NAME NOM	PAGE SEITE PAGE
TRAGACETE 1	586-587	VOLTAGO 2	482-483
TREMEDAL	431	WASAO 1	568-569
TRONDIO	736	ZABALEA	330
TROY 3	256-257	ZAMUDILO	480
TRUNCA	754	ZAPATA	652-653
TUKON 3	688	ZAPATA 1	650
TURCONA-Z	38, 42-43	ZERACO	686
TURIALDO	196	ZINACUA	531
UP 2	724-725	ZOCABON	376
VADUMI	594	ZOLA	604
VALBIANO	632-633	ZUBIALDE	532
VALCASOTTO	442, 498	ZUBIETA-A	82-84
VALDELAGRANO-Z	22		
VALECROSIA	368		
VALLASPRA	246-247		
VALLEMARE	460		
VALMORA	292-293		
VARILLAS	140-141		
VARRAZO	341		
VERADAL	762-763		
VEREDA	511		
VERGIANO	674-675		
VERSUOLA	445		
VETRO	408-409		
VIGLIONI	397		
VIKI 1	785		
VILANOVA	696-697		
VILLABATE	624-627		
VILLABATE 1	730-731		
VINCHIO	600		
VINOVO	262		
VISERBELLA	132-134		



# REGISTER

ARTICLE NUMBER  
ARTIKELNUMMER  
NUMÉROS D'ARTICLE

NUMBER NUMMER NUMÉRO	PAGE SEITE PAGE	NUMBER NUMMER NUMÉRO	PAGE SEITE PAGE	NUMBER NUMMER NUMÉRO	PAGE SEITE PAGE	NUMBER NUMMER NUMÉRO	PAGE SEITE PAGE	NUMBER NUMMER NUMÉRO	PAGE SEITE PAGE	NUMBER NUMMER NUMÉRO	PAGE SEITE PAGE
11801	99	12239	71	31001	668	31592	120	31995	289	33682	574
11802	98	12241	74	31002	669	31594	129	31996	289	33941	546
11804	96	12242	74	31003	668	31595	119	31997	296	33942	547
11805	96	12243	74	31004	668	31596	123	32001	698	33964	547
11806	96	12244	75	31005	670	31599	153	32025	459	33984	234
11807	97	12245	75	31006	671	31601	146	32026	459	33994	21
11809	98	12251	67	31007	671	31602	156	32048	286	39092	308
11811	98	12252	66	31008	671	31603	159	32765	650	39093	309
12221	72	12253	66	31254	504	31605	153	32766	650	39094	309
12222	72	12254	66	31571	127	31606	146	32767	650	39095	308
12223	72	12255	76	31572	116	31607	156	33168	621	39099	306
12224	73	12256	76	31573	121	31608	160	33169	620	39101	306
12225	73	12257	76	31574	125	31611	152	33171	620	39102	307
12226	68	12258	77	31575	126	31613	157	33172	620	39103	306
12227	68	3041	408	31576	117	31614	159	33199	82	39112	310
12228	68	30658	546	31577	121	31616	152	33344	390	39113	310
12229	69	30659	546	31578	125	31618	156	33345	388	39114	310
12231	69	30832	678	31579	126	31619	159	3355	407	39751	206
12232	69	30833	679	31581	116	31627	154	33645	627	39752	206
12233	70	30834	679	31582	120	31628	147	33646	626	39753	206
12234	70	30835	679	31583	124	31629	158	33647	626	39836	278
12235	70	30931	448	31585	116	31631	160	33648	626	39838	278
12236	71	30932	448	31586	120	31666	401	33677	561	39839	279
12237	71	30933	448	31588	127	31667	341	33678	561	43637	440

NUMBER NUMMER NUMÉRO	PAGE SEITE PAGE	NUMBER NUMMER NUMÉRO	PAGE SEITE PAGE	NUMBER NUMMER NUMÉRO	PAGE SEITE PAGE	NUMBER NUMMER NUMÉRO	PAGE SEITE PAGE	NUMBER NUMMER NUMÉRO	PAGE SEITE PAGE	NUMBER NUMMER NUMÉRO	PAGE SEITE PAGE
7184	518	83155	506	86712	520	89758	514	900058	42	900102	48
7186	518	83156	507	86715	521	89832	254	900059	42	900103	54
7188	519	83157	508	86811	242	89833	255	900061	43	900104	54
80263	513	83159	508	86812	242	89834	254	900062	43	900105	52
80264	513	83162	508	86813	240	89835	254	900067	24	900106	52
80265	518	83163	509	86814	240	89836	255	900068	24	900107	53
81262	779	83404	502	86815	240	900001	32	900069	24	900108	58
81265	779	83405	604	86816	242	900002	32	900071	25	900109	59
81635	502	83406	604	86817	243	900005	34	900072	25	900111	50
81636	502	84028	516	86955	778	900006	34	900075	22	900112	50
81827	747	85104	744	87008	406	900008	35	900076	31	900113	50
81828	747	85261	244	87009	406	900019	29	900077	31	900114	56
82305	745	85262	244	87054	404	900021	29	900078	31	900115	56
82741	520	85263	245	87055	401	900022	37	900079	30	900128	35
82747	265	85264	245	87219	602	900023	37	900081	30	900129	35
82748	264	85338	604	87222	602	900024	37	900082	30	90015	520
82749	264	85339	605	87254	744	900025	36	900083	34	90043	512
82751	265	85832	603	87256	744	900044	44	900084	32	90048	260
82752	265	85856	266	87284	784	900045	44	900085	33	90049	260
82785	408	85857	266	87793	521	900046	44	900086	60	90304	250
82786	408	85858	267	88472	660	900047	45	900087	61	90305	250
82842	724	85859	266	88473	661	900048	45	900088	60	90696	341
82843	724	85971	729	88474	660	900049	46	900089	60	90697	522
82844	725	85974	729	88475	660	900051	46	900091	63	90737	522
82942	504	85977	256	88968	793	900052	46	900092	62	90872	775
82944	504	85978	256	88969	793	900053	47	900093	62	90873	775
83119	516	85979	256	89115	521	900054	38	900094	62	90874	775
83132	516	85981	257	89238	513	900055	38	900095	47	90914	690
83153	507	85982	257	89239	512	900056	38	900099	48	90915	690
83154	507	86429	778	89248	514	900057	42	900101	48	90916	690

NUMBER NUMMER NUMÉRO	PAGE SEITE PAGE	NUMBER NUMMER NUMÉRO	PAGE SEITE PAGE	NUMBER NUMMER NUMÉRO	PAGE SEITE PAGE	NUMBER NUMMER NUMÉRO	PAGE SEITE PAGE	NUMBER NUMMER NUMÉRO	PAGE SEITE PAGE	NUMBER NUMMER NUMÉRO	PAGE SEITE PAGE
90917	691	92252	373	92924	708	93706	791	94388	373	94677	764
90927	691	9228	776	92925	708	93707	791	94389	373	94686	791
90967	774	92288	793	92932	706	93708	343	94438	184	94697	772
90977	776	9229	776	92933	708	93709	342	94439	184	94698	723
90978	407	9230	777	92935	706	93713	728	94442	184	94699	772
90982	663	9232	777	93003	255	93784	343	94513	741	94702	772
90984	662	92348	794	93044	738	93836	335	94547	440	94704	773
90985	662	92563	259	93046	736	93874	727	94548	440	94705	723
90986	662	92595	692	93073	342	93875	726	94584	665	94712	588
91002	262	92596	692	93076	766	93876	726	94585	664	94713	588
91004	262	92597	693	93077	766	93877	726	94586	664	94714	588
91005	263	92598	693	93078	764	93901	756	94587	664	94715	590
91006	263	92599	692	93085	698	93917	724	94589	334	94716	590
91007	263	92641	694	93092	341	93949	465	94591	334	94717	590
91236	512	92642	694	93358	697	93952	465	94592	336	94764	187
91238	745	92643	694	93359	696	93965	758	94593	336	94765	187
91242	747	92644	695	93373	392	93966	758	94605	400	94767	187
91433	262	92645	695	93374	392	94144	688	94606	400	94878	562
91496	404	92726	446	93392	464	94145	688	94609	696	94879	562
91589	245	92727	446	93394	464	94146	688	94612	593	94881	568
91971	259	92739	258	93395	466	94244	347	94613	593	94882	568
92084	676	92741	258	93397	466	94245	347	94614	593	94883	569
92085	676	92742	258	93468	404	94251	672	94616	591	94884	568
92086	676	92743	259	93625	340	94252	672	94617	591	94896	230
92087	677	92755	170	93626	340	94319	338	94618	591	94897	231
92143	522	92761	338	93672	684	94329	706	94626	566	94898	231
92146	785	92762	339	93673	684	94353	403	94635	186	94899	231
92147	785	92813	446	93674	684	94354	403	94636	186	94918	127
92206	719	92872	778	93678	686	94377	337	94637	186	94919	118
92251	372	92873	779	93679	686	94378	337	94673	764	94921	121



NUMBER NUMMER NUMÉRO	PAGE SEITE PAGE	NUMBER NUMMER NUMÉRO	PAGE SEITE PAGE	NUMBER NUMMER NUMÉRO	PAGE SEITE PAGE	NUMBER NUMMER NUMÉRO	PAGE SEITE PAGE	NUMBER NUMMER NUMÉRO	PAGE SEITE PAGE	NUMBER NUMMER NUMÉRO	PAGE SEITE PAGE
94924	128	95162	460	95385	393	95599	176	95694	769	96032	490
94925	118	95164	129	95386	735	95602	177	95695	768	96033	490
94926	122	95166	123	95482	666	95605	179	95696	768	96034	490
94935	398	95167	119	95483	666	95606	178	95725	731	96037	548
94936	398	95169	154	95484	667	95607	178	95726	731	96038	548
94938	400	95171	158	95485	666	95608	178	95755	398	96039	550
94946	719	95172	161	95487	501	95609	179	95768	552	96041	551
94958	681	95173	147	95522	209	95628	703	95774	551	96042	549
94959	681	95185	732	95523	209	95629	702	95775	746	96043	549
94961	681	95192	169	95524	209	95631	703	95776	746	96048	533
94962	680	95193	169	95525	208	95632	703	95785	745	96049	533
94963	682	95194	169	95526	208	95639	458	95787	733	96064	598
94964	682	95254	188	95527	208	95655	454	95788	733	96065	598
94965	683	95257	188	95539	716	95656	454	95789	733	96066	598
94966	682	95261	188	95541	716	95657	455	95824	695	96072	409
94967	574	95282	574	95545	652	95658	455	95912	345	96073	409
94973	503	95283	575	95546	652	95659	455	95913	344	96081	790
94987	605	95284	229	95547	653	95661	454	95914	345	96089	511
94989	602	95285	229	95548	652	95662	456	95971	482	96093	294
94995	170	95286	229	95567	287	95663	456	95972	482	96096	294
94998	573	95287	228	95568	286	95664	456	95973	482	96097	294
94999	573	95288	510	95569	285	95672	514	95975	483	96102	284
95001	573	95364	540	95576	461	95675	510	95993	560	96103	284
95044	130	95368	539	95589	181	95677	488	95994	560	96104	284
95045	130	95371	540	95591	180	95679	489	95995	560	96105	285
95055	158	95373	541	95592	180	95681	489	96002	551	96106	285
95118	128	95377	539	95593	180	95682	491	96023	492	96107	287
95119	123	95379	540	95594	181	95684	491	96024	492	96108	287
95122	119	95383	393	95597	177	95686	718	96025	487	96111	511
95147	286	95384	393	95598	177	95689	461	96026	487	96117	510

NUMBER NUMMER NUMÉRO	PAGE SEITE PAGE	NUMBER NUMMER NUMÉRO	PAGE SEITE PAGE	NUMBER NUMMER NUMÉRO	PAGE SEITE PAGE	NUMBER NUMMER NUMÉRO	PAGE SEITE PAGE	NUMBER NUMMER NUMÉRO	PAGE SEITE PAGE	NUMBER NUMMER NUMÉRO	PAGE SEITE PAGE
96178	700	96343	327	96566	530	97362	298	97574	788	97651	252
96179	700	96344	327	96567	530	97363	298	97575	785	97652	253
96181	701	96345	327	96773	326	97364	299	97577	480	97653	252
96182	700	96409	295	96774	326	97365	299	97578	481	97655	253
96183	701	96434	760	96851	501	97366	348	97583	722	97667	784
96193	190	96435	761	96866	295	97367	348	97584	722	97682	162
96194	190	96436	761	96937	582	97368	348	97587	261	97683	162
96195	190	96437	760	96938	582	97408	784	97589	261	97684	163
96199	191	96438	760	96939	582	97435	290	97604	219	97685	162
96201	191	96439	761	96957	770	97479	468	97605	218	97699	562
96211	182	96472	511	96981	394	97487	460	97606	219	97718	584
96214	183	96474	409	96982	394	97506	674	97611	108	97719	584
96219	183	96477	128	96983	394	97507	674	97612	111	97731	436
96229	571	96478	118	96985	395	97508	675	97613	109	97733	358
96231	571	96479	122	96986	395	97509	675	97614	110	97734	358
96257	182	96481	125	97044	757	97516	734	97615	108	97737	484
96258	182	96483	131	97045	757	97526	470	97616	111	97738	485
96259	183	96484	131	97054	564	97527	470	97617	109	97773	736
96261	538	96528	338	97055	564	97528	470	97618	110	97774	737
96264	539	96537	464	97056	564	97531	570	97619	108	97777	106
96305	293	96538	466	97059	600	97536	632	97621	111	97778	107
96306	290	96539	465	97066	371	97537	632	97622	109	97779	106
96307	291	96541	580	97077	707	97538	632	97633	323	97782	106
96308	290	96542	580	97078	768	97539	633	97641	132	97783	107
96325	292	96543	581	97081	594	97541	471	97642	133	97784	107
96326	292	96544	580	97082	594	97542	471	97643	132	97791	246
96327	292	96552	656	97083	594	97543	471	97644	132	97792	246
96329	291	96553	657	97209	743	97571	789	97645	134	97793	246
96331	293	96554	657	97333	743	97572	788	97646	134	97794	247
96332	293	96555	657	97361	298	97573	788	97647	134	97804	218

NUMBER NUMMER NUMÉRO	PAGE SEITE PAGE	NUMBER NUMMER NUMÉRO	PAGE SEITE PAGE	NUMBER NUMMER NUMÉRO	PAGE SEITE PAGE	NUMBER NUMMER NUMÉRO	PAGE SEITE PAGE	NUMBER NUMMER NUMÉRO	PAGE SEITE PAGE	NUMBER NUMMER NUMÉRO	PAGE SEITE PAGE
97805	218	97932	710	98139	624	98294	86	98391	716	98501	600
97806	219	97933	710	98141	625	98295	94	98393	654	98502	600
97838	468	97934	711	98142	624	98296	94	98394	654	98507	431
97839	252	97935	710	98156	436	98297	90	98395	655	98514	445
97841	388	97937	300	98192	362	98309	719	98396	654	98515	445
97845	388	97938	300	98201	91	98311	140	98397	659	98523	330
97846	389	97939	301	98203	91	98313	140	98398	658	98524	330
97854	391	97941	300	98205	90	98314	140	98399	659	98525	331
97855	391	97965	566	98206	90	98315	141	98408	659	98526	331
97857	391	97966	566	98207	88	98317	432	98409	468	98527	462
97871	472	98016	356	98208	88	98318	432	98421	536	98539	422
97872	472	98017	356	98209	88	98319	432	98422	536	98541	534
97873	472	98023	463	98212	92	98323	484	98423	536	98542	534
97874	476	98034	434	98219	87	98324	484	98424	537	98543	534
97875	476	98035	434	98223	87	98325	493	98425	537	98544	535
97876	476	98056	350	98227	85	98326	492	98426	537	98545	535
97877	474	98057	351	98228	85	98331	438	98441	362	98582	322
97878	474	98058	350	98235	87	98332	438	98446	473	98585	322
97879	474	98071	387	98236	86	98333	439	98447	477	98587	168
97881	478	98083	350	98237	86	98334	438	98448	475	98588	168
97882	478	98093	754	98247	754	98346	354	98449	479	98591	396
97883	478	98111	623	98258	489	98347	354	98453	720	98592	396
97884	570	98112	622	98263	527	98351	386	98456	387	98595	335
97885	571	98113	622	98265	527	98352	386	98458	722	98596	336
97886	524	98114	622	98277	794	98353	386	98487	463	98597	459
97895	437	98134	646	98278	741	98379	542	98488	463	98601	495
97903	437	98135	646	98279	794	98384	232	98491	424	98602	495
97904	436	98136	647	98291	322	98385	233	98492	364	98603	494
97914	759	98137	646	98292	92	98386	233	98494	424	98604	495
97915	758	98138	624	98293	92	98387	233	98495	364	98614	320

NUMBER NUMMER NUMÉRO	PAGE SEITE PAGE	NUMBER NUMMER NUMÉRO	PAGE SEITE PAGE	NUMBER NUMMER NUMÉRO	PAGE SEITE PAGE	NUMBER NUMMER NUMÉRO	PAGE SEITE PAGE	NUMBER NUMMER NUMÉRO	PAGE SEITE PAGE	NUMBER NUMMER NUMÉRO	PAGE SEITE PAGE
98615	320	98681	363	98836	365	98888	548	99053	636	99103	730
98616	320	98682	363	98837	743	98889	296	99054	636	99104	731
98617	321	98683	363	98838	382	98891	84	99069	526	99106	21
98621	644	98685	462	98839	382	98892	84	99071	370	99107	346
98622	644	98686	360	98841	531	98893	84	99072	370	99108	481
98623	644	98687	361	98842	49	98894	82	99073	370	99109	481
98624	634	98688	371	98843	55	98895	82	99074	642	99112	533
98625	634	98689	371	98844	51	98896	83	99075	642	99113	721
98626	634	98694	328	98845	56	98907	596	99076	642	99122	558
98628	344	98695	328	98846	52	98908	596	99077	196	99123	558
98629	344	98696	328	98847	58	98909	354	99078	196	99124	558
98647	319	98697	329	98849	54	99013	272	99079	196	99126	526
98648	319	98698	329	98852	57	99014	431	99081	368	99202	606
98649	319	98699	329	98854	58	99015	717	99082	368	99203	606
98651	324	98734	402	98855	762	99016	224	99083	368	99204	609
98652	324	98735	402	98856	762	99017	224	99084	741	99205	608
98653	325	98752	235	98858	358	99018	224	99086	532	99206	606
98654	325	98753	235	98859	740	99019	770	99087	532	99207	607
98655	544	98754	235	98861	426	99021	445	99089	112	99208	608
98656	544	98755	542	98862	426	99033	272	99091	113	99209	608
98657	544	98756	430	98863	426	99034	273	99092	114	99211	611
98661	353	98759	542	98864	742	99035	273	99093	227	99212	610
98662	353	98762	648	98874	268	99036	273	99094	227	99213	610
98663	353	98763	648	98875	268	99041	150	99095	227	99214	610
98674	720	98764	648	98876	268	99042	149	99096	226	99249	366
98675	430	98765	330	98877	269	99043	149	99097	226	99265	576
98676	545	98831	763	98878	269	99044	149	99098	226	99266	576
98677	597	98832	762	98881	435	99045	150	99099	21	99267	576
98678	346	98834	357	98882	435	99046	150	99101	717	99268	578
98679	431	98835	357	98887	746	99052	636	99102	717	99269	578

NUMBER NUMMER NUMÉRO	PAGE SEITE PAGE	NUMBER NUMMER NUMÉRO	PAGE SEITE PAGE	NUMBER NUMMER NUMÉRO	PAGE SEITE PAGE	NUMBER NUMMER NUMÉRO	PAGE SEITE PAGE	NUMBER NUMMER NUMÉRO	PAGE SEITE PAGE	NUMBER NUMMER NUMÉRO	PAGE SEITE PAGE
99271	578	99317	282	99358	367	99408	202	99513	212	99561	271
99272	136	99318	283	99361	450	99413	203	99514	442	99562	270
99273	136	99319	283	99362	450	99429	278	99515	442	99563	271
99274	136	99321	288	99363	450	99438	385	99516	442	99564	271
99275	139	99322	288	99364	451	99439	385	99517	640	99588	29
99276	631	99323	288	99366	238	99445	164	99518	640	99591	221
99277	631	99324	452	99367	238	99446	164	99519	640	99592	220
99278	631	99325	452	99368	238	99447	164	99523	144	99593	221
99279	139	99326	453	99369	239	99451	402	99524	142	99594	221
99285	248	99327	453	99371	236	99452	403	99525	142	99595	528
99286	248	99328	452	99372	236	99457	203	99526	144	99596	529
99287	249	99329	735	99373	237	99463	360	99527	144	99597	749
99288	248	99331	735	99374	236	99464	360	99531	359	99599	364
99289	734	99332	736	99375	274	99465	486	99532	359	99601	22
99292	200	99333	738	99376	274	99466	205	99539	154	99602	23
99293	200	99334	766	99378	274	99467	204	99541	157	99603	22
99294	200	99335	767	99381	276	99468	204	99542	160	99604	23
99295	201	99339	587	99382	276	99469	205	99543	146	99605	23
99296	201	99341	480	99383	276	99486	166	99544	210	99606	552
99297	599	99342	480	99384	277	99487	166	99545	210	99607	552
99298	112	99343	486	99395	422	99488	628	99546	211	99608	553
99299	112	99344	486	99397	500	99489	628	99547	211	99609	553
99301	113	99345	216	99398	500	99491	628	99548	40	99611	167
99302	113	99346	216	99399	501	99492	629	99549	40	99612	166
99303	114	99347	217	99401	366	99506	217	99551	214	99613	142
99304	114	99348	524	99403	366	99507	217	99552	214	99614	316
99313	318	99349	524	99404	488	99508	469	99553	214	99615	316
99314	318	99353	203	99405	488	99509	469	99554	215	99616	316
99315	282	99356	458	99406	494	99511	212	99555	215	99617	317
99316	282	99357	458	99407	494	99512	212	99559	296	99618	377



NUMBER NUMMER NUMÉRO	PAGE SEITE PAGE	NUMBER NUMMER NUMÉRO	PAGE SEITE PAGE	NUMBER NUMMER NUMÉRO	PAGE SEITE PAGE	NUMBER NUMMER NUMÉRO	PAGE SEITE PAGE
99619	377	99673	26	99731	596	99805	281
99621	498	99674	26	99772	612	99806	222
99622	498	99675	26	99773	612	99807	222
99623	498	99676	28	99774	612	99808	223
99624	202	99677	28	99776	586	99809	222
99625	204	99684	64	99777	586	99811	357
99628	333	99685	65	99778	586	99817	422
99629	333	99686	64	99779	496	99818	367
99631	234	99687	64	99781	497	99819	361
99632	234	99689	530	99782	496	99821	361
99633	374	99691	585	99783	496	99822	721
99634	374	99692	584	99784	420	99824	739
99635	375	99693	380	99785	420	99825	738
99636	374	99694	380	99786	420	99828	755
99639	40	99695	381	99787	419	99829	755
99651	332	99696	381	99788	418	99831	756
99654	332	99697	369	99789	419	99832	756
99655	428	99698	369	99791	421	99838	614
99656	428	99699	493	99792	419	99839	614
99659	425	99701	397	99793	424	99853	614
99661	378	99702	397	99794	749	99854	615
99662	378	99703	499	99795	198	99855	198
99663	399	99704	499	99796	199	99856	198
99664	435	99705	376	99797	199		
99665	379	99706	376	99798	199		
99666	379	99707	376	99799	280		
99667	443	99711	638	99801	280		
99669	27	99712	638	99802	280		
99671	27	99713	638	99803	281		
99672	27	99715	720	99804	281		



# NOTES

NOTIZEN  
NOTES

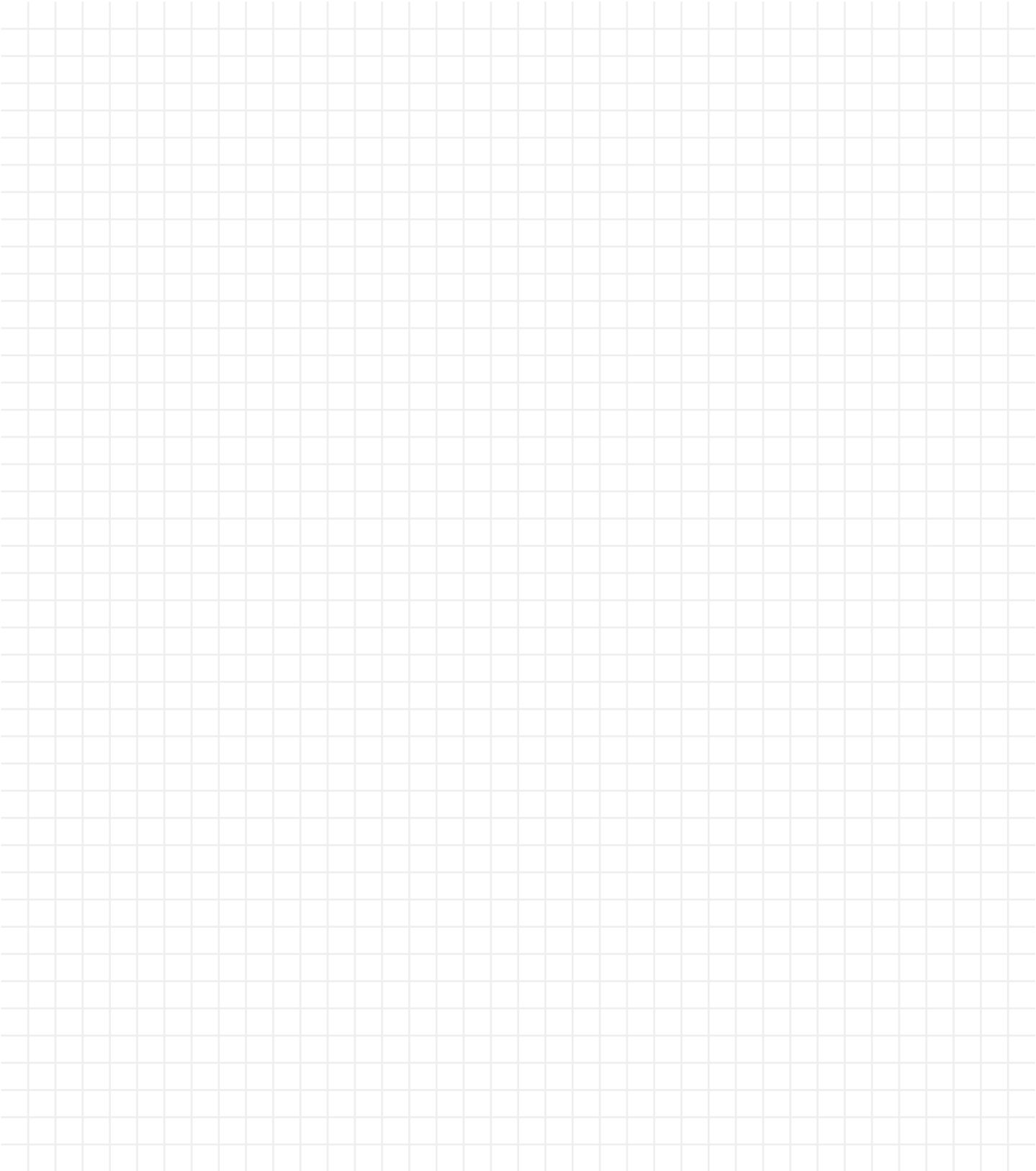

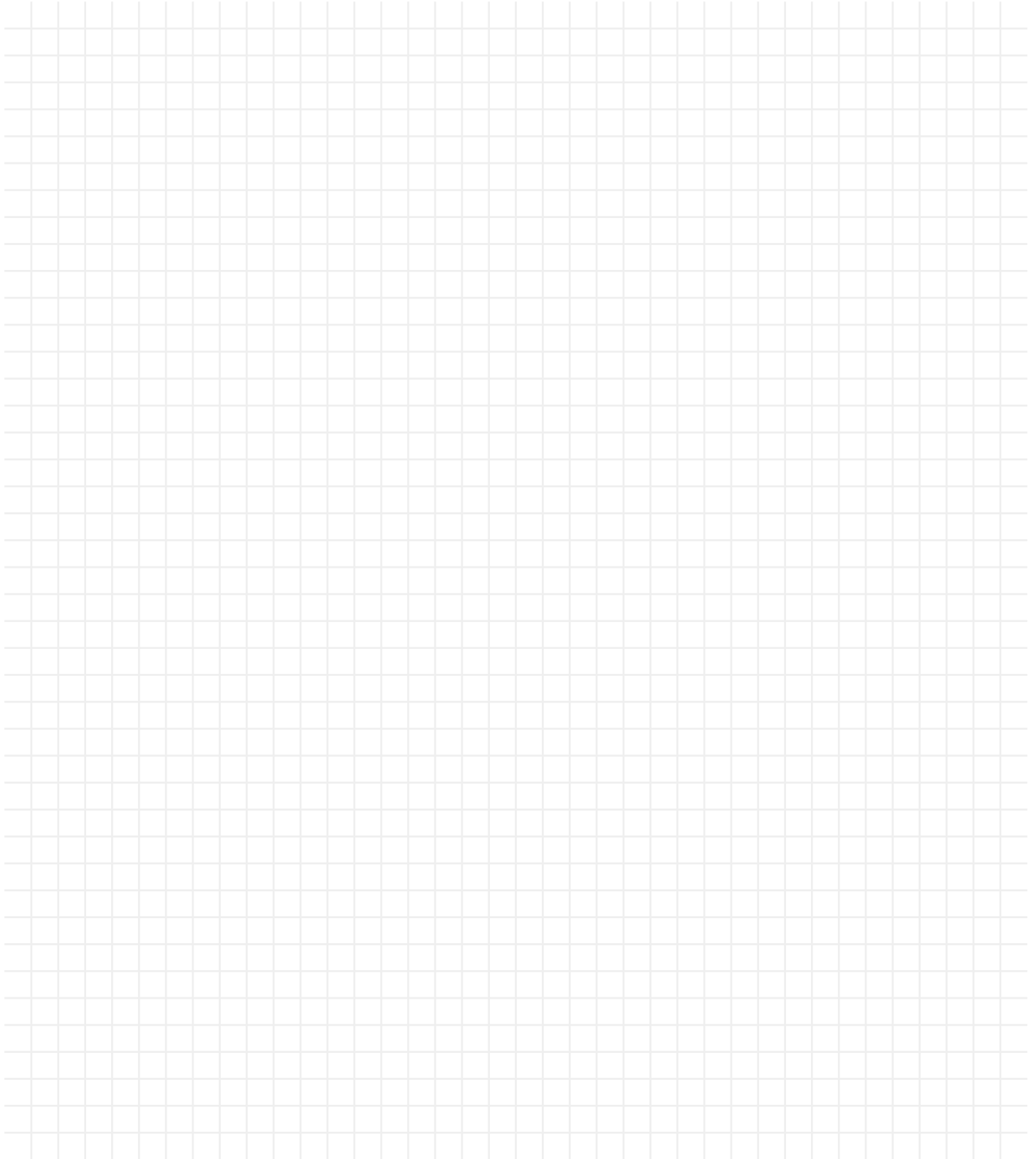

All previous catalogues and price lists are no longer valid with the issue of this catalogue. Errors, misprints, model and price changes and technical modifications are reserved. We deliver based on our terms of delivery and payment. Our products comply with the European light norm EN60598. Products with the ENEC test mark are conforming to the guide line 2006/95/EG. Products with additional safety remarks (e.g protection class, IP) are identified within the product family with the relevant symbol and number. The content of this catalogue is protected under copyright law for EGLO Leuchten GmbH. All rights reserved. Our specific written consent must be obtained before using any illustrations and texts. The pictures are 4C prints and may differ from the original.

The product pictures and ambiances in this catalogue can deviate from reality, and they do not necessarily concur with the usual application of the product. EGLO does not assume liability for the correctness, completeness or the application depiction of the products and/or the product information.

Design, layout and composition: EGLO GmbH, A-6136 Pill - AUSTRIA

Print: Samson Druck GmbH, 5581 St. Margarethen - AUSTRIA

Pictures: EGLO, Adobe Stock, istockphoto.com

---

Mit diesem Katalog verlieren alle vorhergehenden Kataloge und Preislisten ihre Gültigkeit. Irrtümer, Druckfehler, Modell- und Preisänderungen sowie technische Änderungen vorbehalten. Wir liefern zu unseren Liefer- und Zahlungsbedingungen. Unsere Produkte entsprechen der europäischen Leuchtnorm EN 60598. Produkte mit dem ENEC Prüfzeichen sind konform mit der Richtlinie 2006/95/EG. Produkte mit weiteren Sicherheitshinweisen (zB. Schutzklasse, IP) sind mit Symbol und Zahl bei der Produktfamilie ausgezeichnet. Der Inhalt dieses Kataloges ist für die EGLO Leuchten GmbH urheberrechtlich geschützt. Alle Rechte sind vorbehalten. Bilder und Texte dürfen nicht ohne vorherige ausdrückliche, schriftliche Genehmigung verwendet werden. Die Abbildungen sind 4C Drucke und können vom Original abweichen.

Die Katalogbilder und die gezeigten Darstellungen der Produkte können von der Wirklichkeit abweichen und nicht den üblichen Produktanwendungen entsprechen. EGLO übernimmt keine Haftung für die Richtigkeit, Vollständigkeit und Anwendungsdarstellung der Produkte und Produktinformationen.

Gestaltung, Layout und Satz: EGLO GmbH, A-6136 Pill - AUSTRIA

Druck: Samson Druck GmbH, 5581 St. Margarethen - AUSTRIA

Bilder: EGLO, Adobe Stock, istockphoto.com

---

Le présent catalogue remplace tous les catalogues et tarifs précédents. Sous réserve d'erreurs, de fautes d'impression, de modification des modèles et de changement de prix et de technique. Nous livrons sur la base de nos conditions de livraison et de paiement. Nos produits sont conformes aux normes européennes EN 60598 et portent le marquage CE. Les produits portant la marque ENEC sont conformes à la Directive 2006/95/EG. Les produits portant d'autres indications de sécurité (par exemple classe de protection, IP) sont identifiés par le symbole et le nombre correspondants dans la famille de produits.

Le contenu du présent catalogue est protégé pour la société EGLO Leuchten GmbH par un copyright. Tous droits réservés. Toute reproduction d'images et du texte est interdite sans autorisation explicite par écrit préalable. Les images sont imprimées en 4C et peuvent différer de l'original.

Les images des produits et les ambiances dans le catalogue peuvent dévier de la réalité et ne sont pas nécessairement en ligne avec l'usage habituel du produit. EGLO n'engage pas sa responsabilité sur la justesse des images et sur les informations relatives à l'usage pouvant être fait des produits.

Conception, maquette et composition: EGLO GmbH, A-6136 Pill - AUSTRIA

Presse: Samson Druck GmbH, 5581 St. Margarethen - AUSTRIA

Images: EGLO, Adobe Stock, istockphoto.com

06-2021







EGLO Leuchten GmbH  
Heiligkreuz 22  
A-6136 Pill  
Austria  
Tel. +43 (0) 5242 6996  
Fax +43 (0) 5242 6996-972  
info@eglo.com  
www.eglo.com

my light | my style

KAT-21