



EGLO
my light | my style



2021/22

TECHNICAL LIGHT SOLUTIONS

TECHNISCHE LICHTLÖSUNGEN
SOLUTIONS D'ÉCLAIRAGE TECHNIQUE



Dear reader,

Welcome to our extensive range of technical lighting systems! The hallmarks of this range are sleek shapes and minimalist designs paired with superb illumination and a broad range of user-friendly controls... along with many other features you'll love.

To highlight two things we've been working on this year: we've extended our rail system for flexible lighting options in living spaces, and added to our range of LED panels with wooden frames that not only provide great illumination but also create a delightful homely atmosphere.

Liebe Leserin, lieber Leser,

auf den folgenden Seiten erwartet Sie unser umfangreiches Sortiment an technischen Lichtlösungen. Schlanke Bauformen, reduzierte Designs sowie gute Ausleuchtung sind neben den unterschiedlichen und praktischen Steuerungsmöglichkeiten nur ein Teil der Eigenschaften, die dieses Sortiment ausmachen.

Ergänzt haben wir in diesem Jahr insbesondere unsere Schienensysteme zur flexiblen Lichtgestaltung in Wohnräumen sowie LED Panel mit Holzrahmen, die neben ihrer guten Raumausleuchtung durch ihren wohnlichen Charakter bestechen.

Chère lectrice, cher lecteur,







Dans les pages suivantes, vous trouverez notre vaste gamme de solutions d'éclairage technique. Outre ses différentes options de commande très pratiques, cette gamme se caractérise aussi par des formes élancées, des designs minimalistes et une bonne qualité d'éclairage.

Cette année, nous avons notamment parfait nos systèmes de rails pour un agencement flexible de l'éclairage dans les espaces de vie ainsi que nos panneaux LED avec des châssis en bois, qui séduisent non seulement par leur qualité d'éclairage mais aussi par leur caractère convivial.



CONTENTS

INHALT
CONTENU

	EGLO CONNECT	4-45
	EGLO ACCESS	46-59
 RECESSED & SURFACE LUMINAIRES	LED PANEL LUMINAIRES LED PANEELLEUCHTEN LUMINAIRES LAMBRIS LED	
	DECORATIVE BASIC FRAMELESS WITH SUSPENSION FRAME DIMMABLE WOOD FRAME	60-109
	RECESSED LUMINAIRES EINBAULEUCHTEN ENCASTRABLES	
	HIGH VOLTAGE FUEVA 5 FUEVA FLEX LOW VOLTAGE EGLO TRACK SYSTEMS WITH BULBS	110-213
	SURFACE LUMINAIRES AUFBAULEUCHTEN LUMINAIRES EN SAILLIE	
	FUEVA DECORATIVE	214-257
	LED STRIPES	258-265
	LED PROFILES	266-309
	LEGEND & REGISTER	310-320

connect.2































































Discover the smart world





OVERVIEW

							
REMOTE 2.0 p. 15	SALICETO-Z p. 17	SALICETO-Z p. 17	SALICETO-Z p. 17	TURCONA-Z p. 18	TURCONA-Z p. 18	TURCONA-Z p. 18	HERRORA-Z p. 20
							
HERRORA-Z p. 20	HERRORA-Z p. 20	TURCONA-Z p. 22	TURCONA-Z p. 22	TURCONA-Z p. 22	TURCONA-Z p. 23	TURCONA-Z p. 23	SALOBRENA-Z p. 24
							
SALOBRENA-Z p. 24	SALOBRENA-Z p. 24	SALOBRENA-Z p. 25	SALOBRENA-Z p. 25	SALOBRENA-Z p. 26	SALOBRENA-Z p. 26	SALOBRENA-Z p. 26	SALOBRENA-Z p. 27
							
SALOBRENA-Z p. 27	FUEVA-Z p. 28	FUEVA-Z p. 28	FUEVA-Z p. 28	FUEVA-Z p. 29	FUEVA-Z p. 30	FUEVA-Z p. 30	FUEVA-Z p. 30
							
FUEVA-Z p. 31	FUEVA-Z p. 32	FUEVA-Z p. 32	FUEVA-Z p. 32	FUEVA-Z p. 33	FUEVA-Z p. 34	FUEVA-Z p. 34	FUEVA-Z p. 34
							
FUEVA-Z p. 35	FUEVA-Z p. 36	FUEVA-Z p. 36	FUEVA-Z p. 36	FUEVA-Z p. 37	FUEVA-Z p. 38	FUEVA-Z p. 38	FUEVA-Z p. 38
							
FUEVA-Z p. 39	ROVITO-Z p. 40	ROVITO-Z p. 40	ROVITO-Z p. 40	ROVITO-Z p. 41	ROVITO-Z p. 42	ROVITO-Z p. 42	ROVITO-Z p. 42
							
ROVITO-Z p. 43	LED STRIPE-Z p. 44	LED STRIPE-Z p. 44	LED STRIPE-Z p. 44	LED STRIPE-Z p. 45			

connect.z combines two control technologies in one system

connect.z vereint zwei Steuerungstechnologien in einem System

connect.z réunit deux technologies de commande au sein d'un même système



ZigBee is far and away the most widely used standard in the smart home world.

ZigBee ist der am weitesten verbreitete Standard in der Smart Home Welt.

ZigBee est le protocole le plus répandu au monde dans le domaine du Smart Home.

ADVANTAGES :

- › Mesh network
- › Direct connection with Amazon Echo and Google Home
- › Compatible with products from different manufacturers
- › High level of security
- › Easy setup
- › Energy efficient

VORTEILE:

- › Mesh-Netzwerk
- › Direkte Verbindung mit Amazon Echo und Google Home
- › Herstellerübergreifend kompatibel
- › Hohe Sicherheit
- › Einfache Einrichtung
- › Energieeffizient

AVANTAGES:

- › Réseau maillé
- › Connexion directe à Amazon Echo et Google Home
- › Compatible indépendamment du fabricant
- › Sécurité élevée
- › Installation facile
- › Économe en énergie

connect.2



Bluetooth is an established standard in the digital world.
Bluetooth ist ein etablierter Standard in der digitalen Welt.
Bluetooth est un standard de communication reconnu dans le monde numérique.

ADVANTAGES:

- › Local & secure network
- › Protocol is mainly audio (low debit)
- › Mesh network: Elements are receivers and senders
- › Easy setup
- › Usable offline
- › Energy efficient

VORTEILE:

- › Lokales & sicheres Netzwerk Protokoll hauptsächlich Audio (Low Debit)
- › Mesh-Netzwerk: Elemente sind Empfänger und Sender
- › Einfache Einrichtung
- › Offline nutzbar
- › Energieeffizient

AVANTAGES:

- › Réseau local et sûr
- › Protocole essentiellement audio (bas débit)
- › Réseau maillé : les éléments sont l'émetteur et le récepteur
- › Installation facile
- › Utilisable hors-ligne
- › Économe en énergie

Light up your world!

Bringen Sie Licht in Ihren Alltag!
Illuminez votre quotidien !



connect.z offers a wide range of lamps and lighting equipment. Select products from the following options according to your needs:
connect.z bietet ein großes Sortiment an Leuchten und Leuchtmitteln. Wählen Sie die Produkte ganz nach Ihren Bedürfnissen aus folgenden Varianten:
connect.z propose une large gamme de luminaires et d'ampoules. Sélectionnez les produits en fonction de vos besoins parmi les variantes suivantes :

Warm White

Neutral White

Tunable White

Individual light from 50,000 white tones.
Individuelles Licht aus 50.000 Weißtönen.
Luminaire individuel à 50 000 tons de blanc.

TW + RGB Colors

Diverse lighting selection from 50,000 white tones and 16 million colours.
Vielseitige Lichtauswahl aus 50.000 Weißtönen und 16 Mio. Farben.
Sélection étendue de luminaires à 50 000 tons de blanc et 16 millions de couleurs.

Enjoy relaxing moments!
Genießen Sie entspannte Momente!
Profitez de moments de détente !

Stay focussed & efficient!
Bleiben Sie konzentriert & leistungsfähig!
Restez concentré(e) et performant(e) !

Start the day fresh every morning!
Starten Sie jeden Morgen frisch in den Tag!
Commencez la journée du bon pied !

Create the perfect atmosphere!
Kreieren Sie Ihr perfektes Ambiente!
Créez votre ambiance parfaite !



Enjoy many useful convenience features:

Es erwarten Sie viele nützliche Komfortfunktionen:

De nombreuses fonctionnalités utiles vous attendent pour votre confort :



TIMERS AND CALENDARS / TIMER UND ZEITPLÄNE/ MINUTERIE ET CALENDRIER

Make your daily life easier with timers and calendars.
Wake up relaxed with the simulated sunrise.

Unterstützen Sie Ihren Alltag mit Timern und Zeitplänen. Entwickeln Sie eigene Lichtroutinen und machen Sie Ihr Leben leichter.

Facilitez-vous la vie à l'aide de la fonction minuterie et calendrier.
Réveillez-vous en douceur grâce au simulateur de lever de soleil



LIGHT ALARM CLOCK/ LICHTWECKER/ REVEIL LUMINEUX

You'd rather not start your day in a bad mood? Wake up relaxed with the simulated sunrise.

Keine Lust mit schlechter Laune in den Tag zu starten? Entspannt aufwachen mit dem simulierten Sonnenaufgang.

Pas envie de commencer la journée de mauvaise humeur ? Réveillez-vous en douceur grâce au simulateur de lever de soleil.



DISCO FUNCTION/MODE/ DISCOFUNKTION/MODUS/ FONCTION/MODE DISCO

For the perfect party mood, the disco function synchronises the light to the beat of your favourite songs.

Für die perfekte Partystimmung schaltet die Discofunktion das Licht passend zum Beat Ihres Lieblingsongs.

Pour une ambiance festive parfaite, la fonction disco enclenche le luminaire au rythme de votre chanson préférée.



PRESENCE SIMULATOR/ ANWESENHEITSSIMULATION/ SIMULATEUR DE PRESENCE

Protect your home with the convenient presence simulator. Variable time intervals allow the system to turn the lights on and off to simulate your presence at home and deter unwanted guests.

Schütze Sie Ihr Zuhause mit der komfortablen Anwesenheitssimulation. Dank variabler Zeitintervalle simuliert das System durch Ein- und Ausschalten der Beleuchtung die Anwesenheit im Haus und schreckt so ungebetene Gäste ab.

Protégez votre domicile à l'aide du très pratique simulateur de présence. Le système simule votre présence en allumant et en éteignant les lumières à intervalles variables et décourage ainsi les invités indésirables.

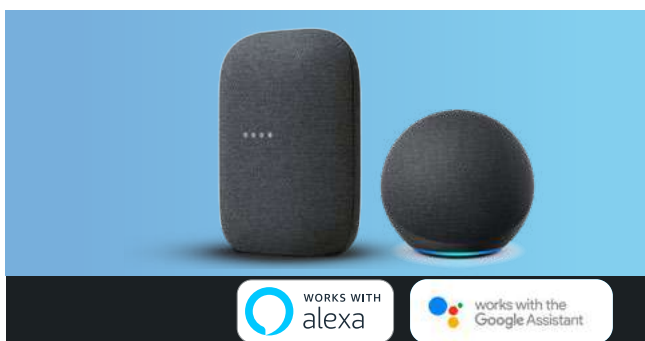

VOICE COMMANDS/ SPRACHSTEUERUNG/COMMANDE VOCALE

More convenient! Turn the light on whenever you want with only a voice command.

Noch komfortabler! Mit nur einem Sprachbefehl schaltet sich das Licht nach Ihren Wünschen an und aus.

C'est encore plus confortable ! Allumez votre luminaire comme vous le souhaitez d'une simple commande vocale.

Control options

Steuerungsmöglichkeiten
Possibilités de commande



Set your smart home as you prefer! With the app, voice commands, or remote control.

Steuern Sie Ihr Smart Home wie Sie es möchten! Via App, Sprachsteuerung oder mit der Fernbedienung.

Commandez votre Smart Home comme vous le souhaitez ! Via l'appli, la commande vocale ou la télécommande.



APP CONTROL

Use the free app for smartphone, tablet, or smartwatch.

Nutzen Sie die kostenlose App für das Smartphone, Tablet oder die Smartwatch.

Utilisez l'appli gratuite sur votre smartphone, votre tablette ou votre montre connectée.



VOICE COMMANDS

Use intelligent voice assistants such as Google Home and Amazon Alexa.

Nutzen Sie intelligente Sprachassistenten wie Google Home und Amazon Alexa.

Utilisez des assistants vocaux intelligents comme Google Home ou Amazon Alexa.



REMOTE CONTROL

Use the practical remote connect.z operation at any time.

Nutzen Sie auch jederzeit die praktische connect.z Fernbedienung.

Vous pouvez aussi utiliser à tout moment la télécommande connect.z.



CONNECT.Z ACCESSORIES

Use clever accessories such as the movement sensor and much more.

Nutzen Sie cleveres Zubehör wie z.B. den Bewegungssensor uvm.

Utilisez des accessoires malins tels que le capteur de mouvement et bien d'autres encore.



DIMMER FUNCTION

Use the practical dimmer function via app, speech command or remote control.

Nutzen Sie die praktische Dimmfunktion via App, Sprachbefehl oder Fernbedienung.

Utilisez la fonction de gradation via l'appli, la commande vocale ou la télécommande.

One system, many possibilities!

Ein System – viele Möglichkeiten!

Un système, de nombreuses possibilités!

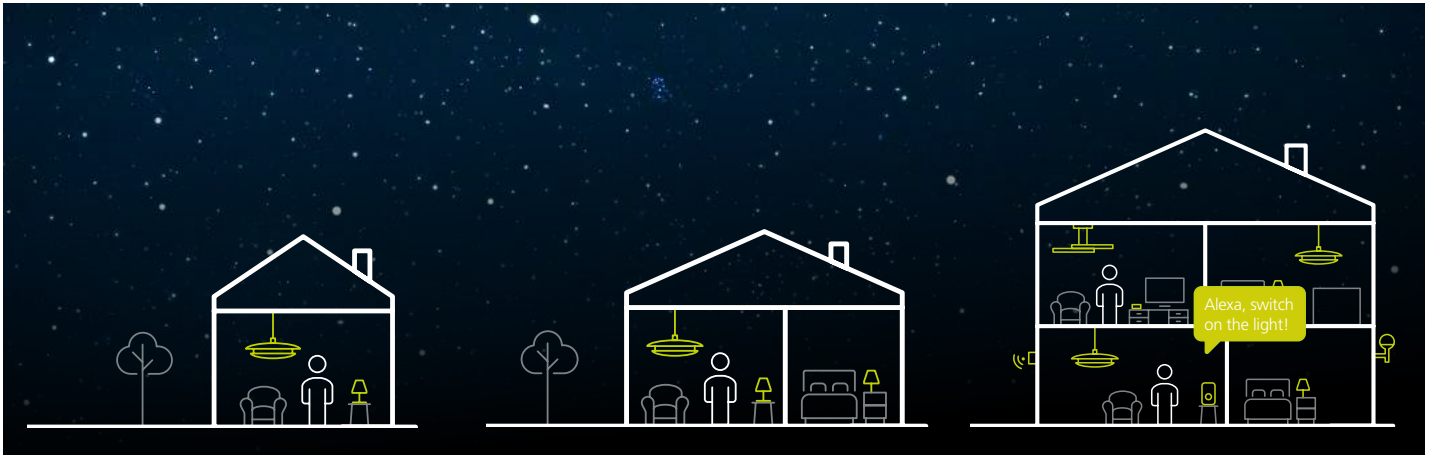

No matter how you start, you can integrate new products into your connect.z system at any time and gradually expand your smart home. Egal wie Sie starten, Sie können jederzeit neue Produkte in Ihr connect.z System integrieren und Ihr smartes Zuhause nach und nach erweitern. Quel que soit votre choix, vous pouvez à tout moment intégrer de nouveaux produits à votre système connect.z et améliorer progressivement votre maison intelligente.

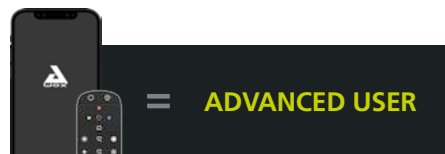

All you need to start is a connect.z product and the remote control. No internet connection is required and you have access to:

Sie benötigen zum Start lediglich ein connect.z Produkt und die Fernbedienung. Es wird kein Internetzugang benötigt und Sie haben Zugriff auf:

Pour démarrer, il vous suffit d'un produit connect.z et de la télécommande. Aucune connexion Internet n'est nécessaire. Vous avez accès aux :

Standard functions: Standardfunktionen: Fonctionnalités standard :

- › Select colour/ Farbauswahl/ sélection de couleur
- › Change colour/ Farbwechsel/ changement de couleur
- › Dim/ Dimmen/ gradation
- › Favourites (2x)/ Favoriten (2x)/ favoris (2x)
- › Groups (3x)/ Gruppen (3x)/ groupes (3x)
- › Candle mode/ Kerzenmodus/ mode bougie

Besides the standard functions, would you also like access to the practical convenience features? Then you need only your smartphone or tablet and the Awox app. This app allows you to control your lights via WIFI and Bluetooth®.

Sie möchten zu den Standardfunktionen auch noch Zugriff auf die praktischen Komfortfunktionen haben? Dann benötigen Sie nur Ihr Smartphone oder Tablet und die Awox App. Mit der App haben Sie die Möglichkeit, Ihre Leuchten über WLAN und Bluetooth® zu steuern.

Outre les options standard, vous souhaitez également pouvoir utiliser les fonctionnalités de confort les plus pratiques ? Pour cela, vous avez seulement besoin de votre smartphone ou de votre tablette et de l'appli Awox. L'appli vous permet de commander vos luminaires via le réseau Wi-Fi ou Bluetooth®.

Standard functions + convenience features/ Standardfunktionen + Komfortfunktionen / Fonctionnalités standard + confort

- › Light alarm clock/ Lichtwecker/ réveil lumineux
- › Presence simulation/ Anwesenheitssimulation/ simulateur de présence
- › Disco function/ Discofunktion/ fonction disco
- › Timers & timetables /Timer & Zeitpläne/ minuteur et calendrier
- › Accessories can be incorporated/ Einbindung von Zubehör möglich/ connexion d'accessoires possible

Use the system's full potential and control your smart home through the Awox app using WIFI or Bluetooth® as well as integrating a voice assistant into the system. This gives you:

Nutzen Sie das volle Potenzial des Systems und steuern Sie Ihr Smart Home über die Awox App mithilfe von WLAN oder Bluetooth® und integrieren Sie zusätzlich noch einen Sprachassistenten in das System. So mit erhalten Sie:

Exploitez tout le potentiel du système en commandant votre Smart Home grâce à l'appli Awox via le réseau Wi-Fi ou Bluetooth®, et intégrez également un assistant vocal au système. Vous obtenez ainsi :

Standard functions + convenience features + voice commands*

Standardfunktionen + Komfortfunktionen + Sprachsteuerung*

Fonctionnalités standard + confort + commande vocale*

- › Amazon Alexa or Google Home/ Amazon Alexa oder Google Home/ Amazon Alexa ou Google Home

- * Use a voice assistant with integrated bridge.
- * Nutzen Sie einen Sprachassistenten mit integrierter Bridge.
- * Utilisez un assistant vocal avec Bridge intégré.

YOU ALREADY HAVE CONNECT-C LUMINAIRES FROM THE PREVIOUS SYSTEM! WHAT NOW?

Sie besitzen bereits connect-c Leuchten des Vorgängersystems! Was nun?
Vous disposez déjà de luminaires connect-c de l'ancien système! Que faire ?

No problem! The previous connect-c products are compatible with the new connect.z system.
Kein Problem! Die bisherigen connect-c Produkte sind mit dem neuen connect.z System kompatibel.
Aucun problème! Les anciens produits connect-c sont compatibles avec le nouveau système connect.z.

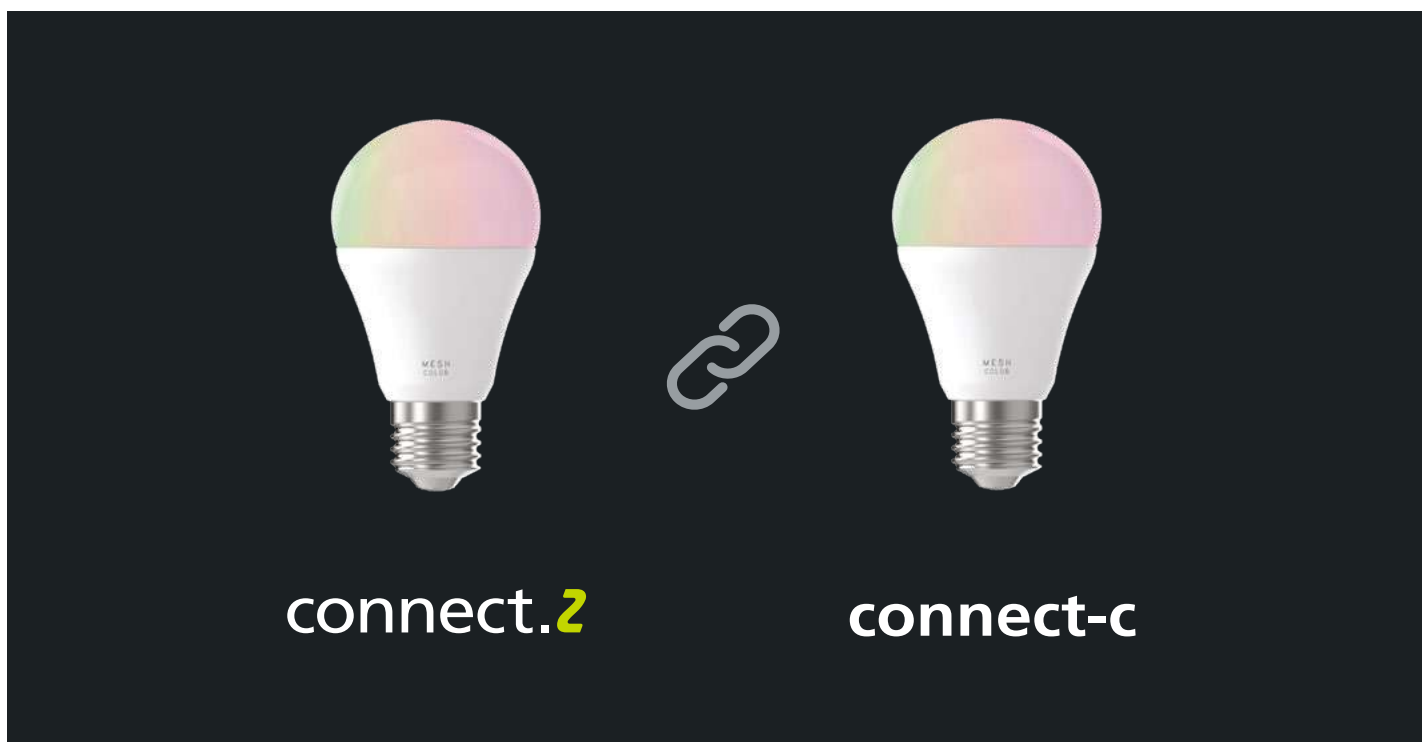

EGLO connect-c - connect.z
The existing EGLO connect-c system is compatible with the new EGLO connect.z system. You don't need to switch from the existing Bluetooth low energy system to the new open protocol ZigBee 3.0. Lights from EGLO connect-c can be incorporated into the existing EGLO connect.z system.

EGLO connect-c - connect.z
Das bestehende EGLO connect-c System ist mit dem neuen EGLO connect.z System kompatibel. Sie müssen nicht von dem bestehendem Bluetooth low energy System auf das neue offene Protokoll ZigBee 3.0 umsteigen. Leuchten von EGLO connect-c können in das bestehende EGLO connect.z System eingebunden werden.

EGLO connect-c - connect.z
Le système EGLO connect-c existant est compatible avec le nouveau système EGLO connect.z. Vous n'avez pas besoin de passer du système Bluetooth à basse consommation existant au nouveau protocole ouvert ZigBee 3.0. Les luminaires EGLO connect-c peuvent être intégrés au système EGLO connect.z existant.



99099

99099 REMOTE 2.0

remote control; plastic, grey
Fernbedienung; Kunststoff, grau
Télécommande; plastique, gris

L 122, B 54, H 18



ACCU
AAA,
R03P



1,5V



9 002759 990992





99669





99669



99672



99671



99669 SALICETO-Z

recessed light; aluminium, black
 Einbauleuchte; Alu, schwarz
 luminaire encastrable; aluminium, noir

H 46, Ø 88, ET 50



99671 SALICETO-Z

recessed light; aluminium, white
 Einbauleuchte; Alu, weiss
 luminaire encastrable; aluminium, blanc

H 46, Ø 88, ET 50

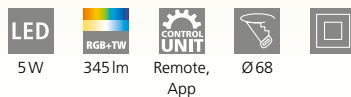

99672 SALICETO-Z

recessed light; aluminium, satin nickel
 Einbauleuchte; Alu, nickel-matt
 luminaire encastrable; aluminium, nickel mat

H 46, Ø 88, ET 50

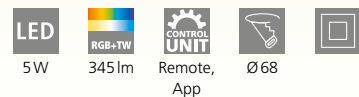



900054



900055



900056



900054 TURCONA-Z

ceiling light; steel, aluminium, white / plastic, white
Deckenleuchte; Stahl, Alu, weiss / Kunststoff, weiss
plafonnier; acier, aluminium, blanc / plastique, blanc

H 60, Ø 300

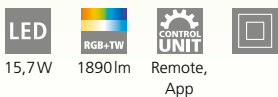

15,7W 1890lm Remote, App



9 008606 221905



Ø 300

900055 TURCONA-Z

ceiling light; steel, aluminium, white / plastic, white
Deckenleuchte; Stahl, Alu, weiss / Kunststoff, weiss
plafonnier; acier, aluminium, blanc / plastique, blanc

H 60, Ø 450



22,4W 2690lm Remote, App



9 008606 221912



Ø 450

900056 TURCONA-Z

ceiling light; steel, aluminium, white / plastic, white
Deckenleuchte; Stahl, Alu, weiss / Kunststoff, weiss
plafonnier; acier, aluminium, blanc / plastique, blanc

H 60, Ø 600



34,2W 4100lm Remote, App



9 008606 221929

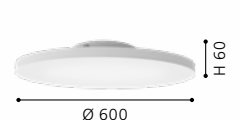

Ø 600



900055

LED



Travel makes
you realize that
no matter how
much you know,
there's always
more to learn.





99639



99548



99549



99639 HERRORA-Z

ceiling light; aluminium, white / plastic, white
Deckenleuchte; Alu, weiss / Kunststoff, weiss
plafonnier; aluminium, blanc / plastique, blanc

L 450, B 450, H 40



22W 2600lm Remote, App

99548 HERRORA-Z

ceiling light; aluminium, white / plastic, white
Deckenleuchte; Alu, weiss / Kunststoff, weiss
plafonnier; aluminium, blanc / plastique, blanc

L 595, B 595, H 40

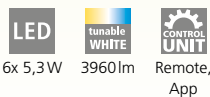

6x 5,3W 3960lm Remote, App

99549 HERRORA-Z

ceiling light; aluminium, white / plastic, white
Deckenleuchte; Alu, weiss / Kunststoff, weiss
plafonnier; aluminium, blanc / plastique, blanc

L 1200, B 300, H 40

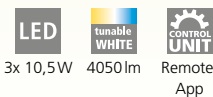

3x 10,5W 4050lm Remote, App



9 002759 996390



9 002759 995485



9 002759 995492





99639

LED



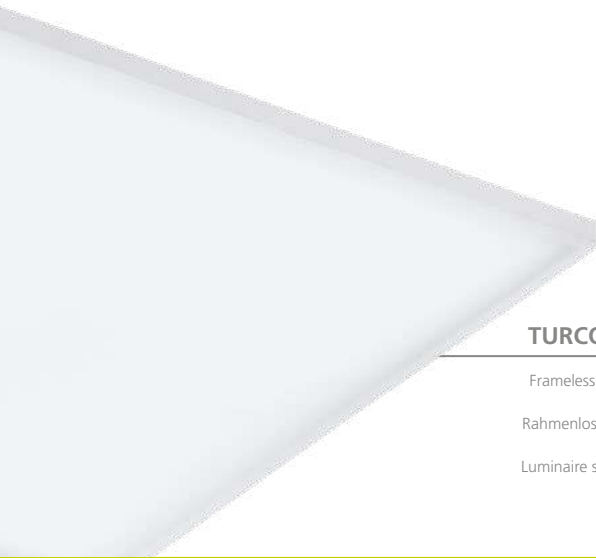
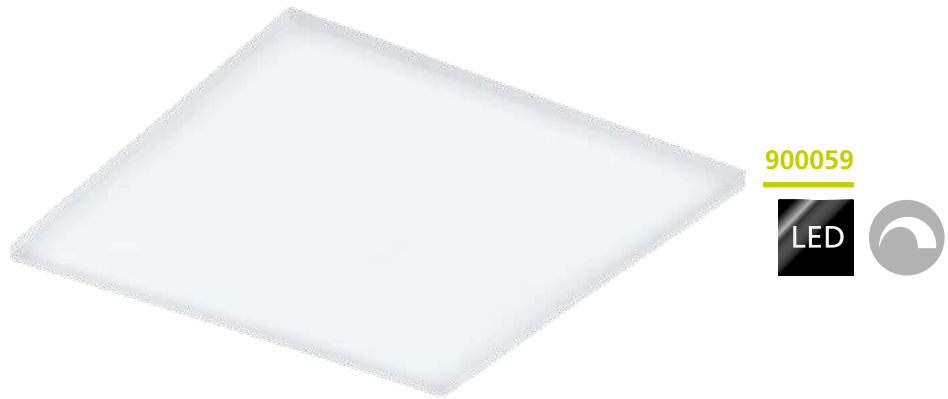

TURCONA-Z

Frameless luminaire

Rahmenlose Leuchte

Luminaire sans cadre

900057 TURCONA-Z

ceiling light; steel, aluminium, white / plastic, white
Deckenleuchte; Stahl, Alu, weiss / Kunststoff, weiss
plafonnier; acier, aluminium, blanc / plastique, blanc

L 300, B 300, H 50

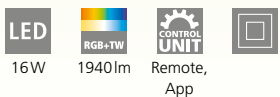

900058 TURCONA-Z

ceiling light; steel, aluminium, white / plastic, white
Deckenleuchte; Stahl, Alu, weiss / Kunststoff, weiss
plafonnier; acier, aluminium, blanc / plastique, blanc

L 450, B 450, H 50

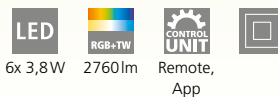

900059 TURCONA-Z

ceiling light; steel, aluminium, white / plastic, white
Deckenleuchte; Stahl, Alu, weiss / Kunststoff, weiss
plafonnier; acier, aluminium, blanc / plastique, blanc

L 600, B 600, H 50



9 008606 221936



9 008606 221943

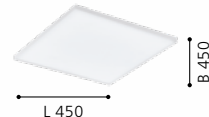

9 008606 221950

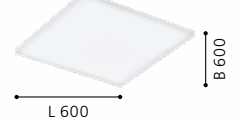



900061



900062



900061



900062 TURCONA-Z

ceiling light; steel, aluminium, white / plastic, white
Deckenleuchte; Stahl, Alu, weiss / Kunststoff, weiss
plafonnier; acier, aluminium, blanc / plastique, blanc

L 1200, B 100, H 50



34,2W



4060lm



Remote,
App



900061 TURCONA-Z

ceiling light; steel, aluminium, white / plastic, white
Deckenleuchte; Stahl, Alu, weiss / Kunststoff, weiss
plafonnier; acier, aluminium, blanc / plastique, blanc

L 1200, B 300, H 50



3x 10,6W



4000lm



Remote,
App



9 008606 221974

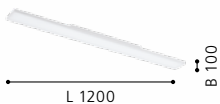

9 008606 221967

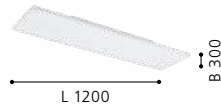



900044



900045



900046



900044 SALOBRENA-Z

ceiling light; aluminium, white / plastic, white
Deckenleuchte; Alu, weiss / Kunststoff, weiss
plafonnier; aluminium, blanc / plastique, blanc

L 300, B 300, H 50

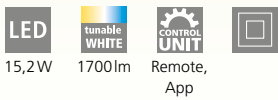

15,2W 1700lm Remote, App

900045 SALOBRENA-Z

ceiling light; aluminium, white / plastic, white
Deckenleuchte; Alu, weiss / Kunststoff, weiss
plafonnier; aluminium, blanc / plastique, blanc

L 450, B 450, H 50

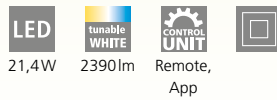

21,4W 2390lm Remote, App

900046 SALOBRENA-Z

ceiling light; aluminium, white / plastic, white
Deckenleuchte; Alu, weiss / Kunststoff, weiss
plafonnier; aluminium, blanc / plastique, blanc

L 595, B 595, H 50

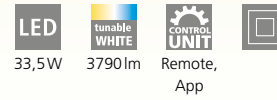

33,5W 3790lm Remote, App



9 008606 221813



L 300



9 008606 221820



L 450



9 008606 221837



L 595



900047



900048



900047 SALOBRENA-Z

ceiling light; aluminium, white / plastic, white
Deckenleuchte; Alu, weiss / Kunststoff, weiss
plafonnier; aluminium, blanc / plastique, blanc

L 1200, B 300, H 50

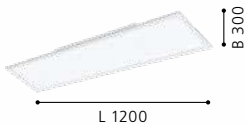
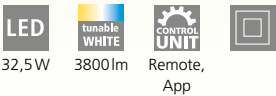

900048 SALOBRENA-Z

ceiling light; aluminium, white / plastic, white
Deckenleuchte; Alu, weiss / Kunststoff, weiss
plafonnier; aluminium, blanc / plastique, blanc

L 1200, B 100, H 45

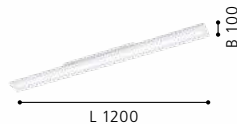

ACCESSORIES INCLUDED



Zubehör inkludiert
Accessoires inclus



900049



900051



900052



900049 SALOBRENA-Z

ceiling light; aluminium, black / plastic, white
Deckenleuchte; Alu, schwarz / Kunststoff, weiss
plafonnier; aluminium, noir / plastique, blanc

L 300, B 300, H 50

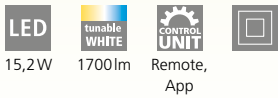

15,2W 1700lm Remote, App

900051 SALOBRENA-Z

ceiling light; aluminium, black / plastic, white
Deckenleuchte; Alu, schwarz / Kunststoff, weiss
plafonnier; aluminium, noir / plastique, blanc

L 450, B 450, H 50

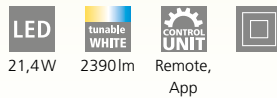

21,4W 2390lm Remote, App

900052 SALOBRENA-Z

ceiling light; aluminium, black / plastic, white
Deckenleuchte; Alu, schwarz / Kunststoff, weiss
plafonnier; aluminium, noir / plastique, blanc

L 595, B 595, H 50

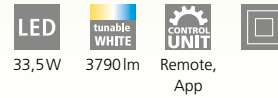

33,5W 3790lm Remote, App



9 008606 221868



9 008606 221875



9 008606 221882





900053



900095



900053 SALOBRENA-Z

ceiling light; aluminium, black / plastic, white
Deckenleuchte; Alu, schwarz / Kunststoff, weiss
plafonnier; aluminium, noir / plastique, blanc

L 1200, B 300, H 50



32,5W



3800lm



Remote,
App



900095 SALOBRENA-Z

ceiling light; aluminium, steel, black / plastic, white
Deckenleuchte; Alu, Stahl, schwarz / Kunststoff, weiss
plafonnier; aluminium, acier, noir / plastique, blanc

L 1200, B 100, H 45



32,5W



3800lm



Remote,
App



9 008606 221899



9 008606 225552

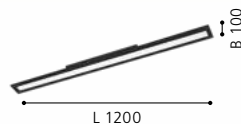



900099

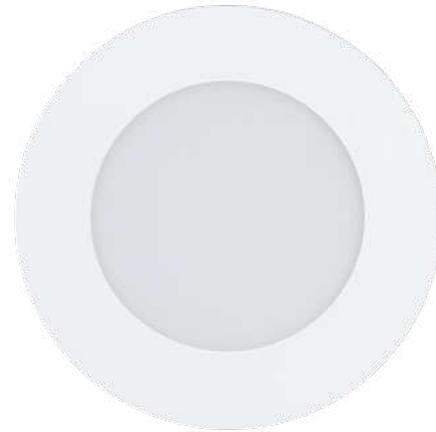

900101

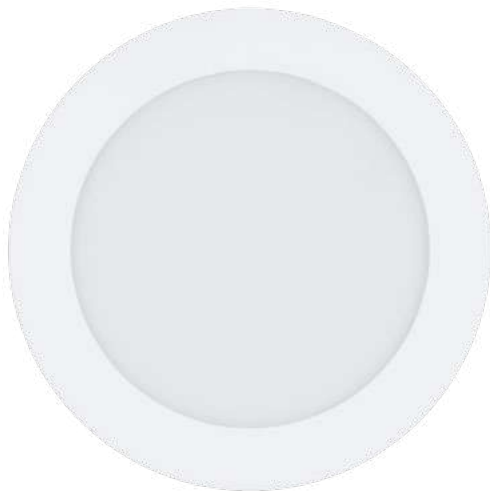

900102



900099 FUEVA-Z

recessed light; steel, white / plastic, white
Einbauleuchte; Stahl, weiss / Kunststoff, weiss
luminaire encastrable; acier, blanc / plastique, blanc

H 26, Ø 85

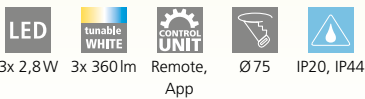

3x 2,8W 3x 360lm Remote, App Ø 75 IP20, IP44



9 008606 225569



Ø 85

900101 FUEVA-Z

recessed light; steel, white / plastic, white
Einbauleuchte; Stahl, weiss / Kunststoff, weiss
luminaire encastrable; acier, blanc / plastique, blanc

H 26, Ø 120

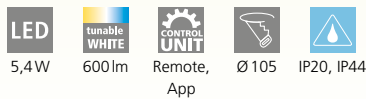

5,4W 600lm Remote, App Ø 105 IP20, IP44



9 008606 225576



Ø 120

900102 FUEVA-Z

recessed light; steel, white / plastic, white
Einbauleuchte; Stahl, weiss / Kunststoff, weiss
luminaire encastrable; acier, blanc / plastique, blanc

H 26, Ø 165

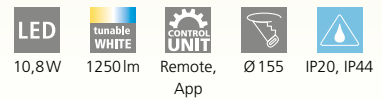

10,8W 1250lm Remote, App Ø 155 IP20, IP44



9 008606 225583

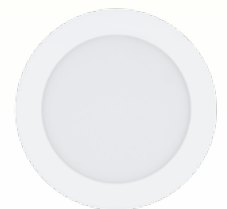

Ø 165

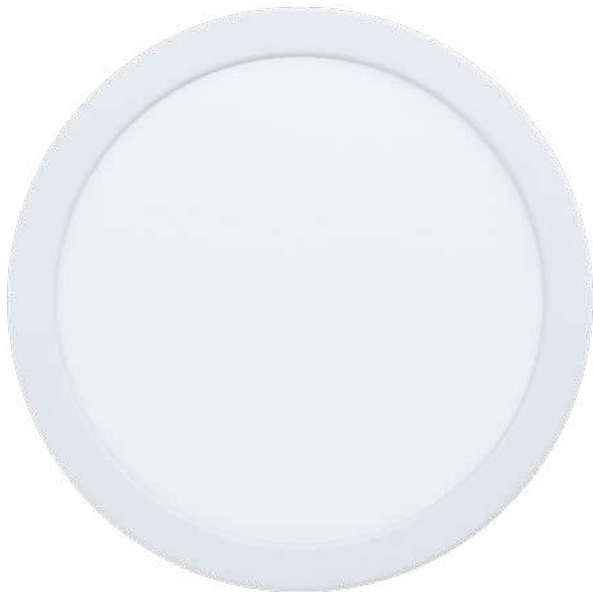

98842

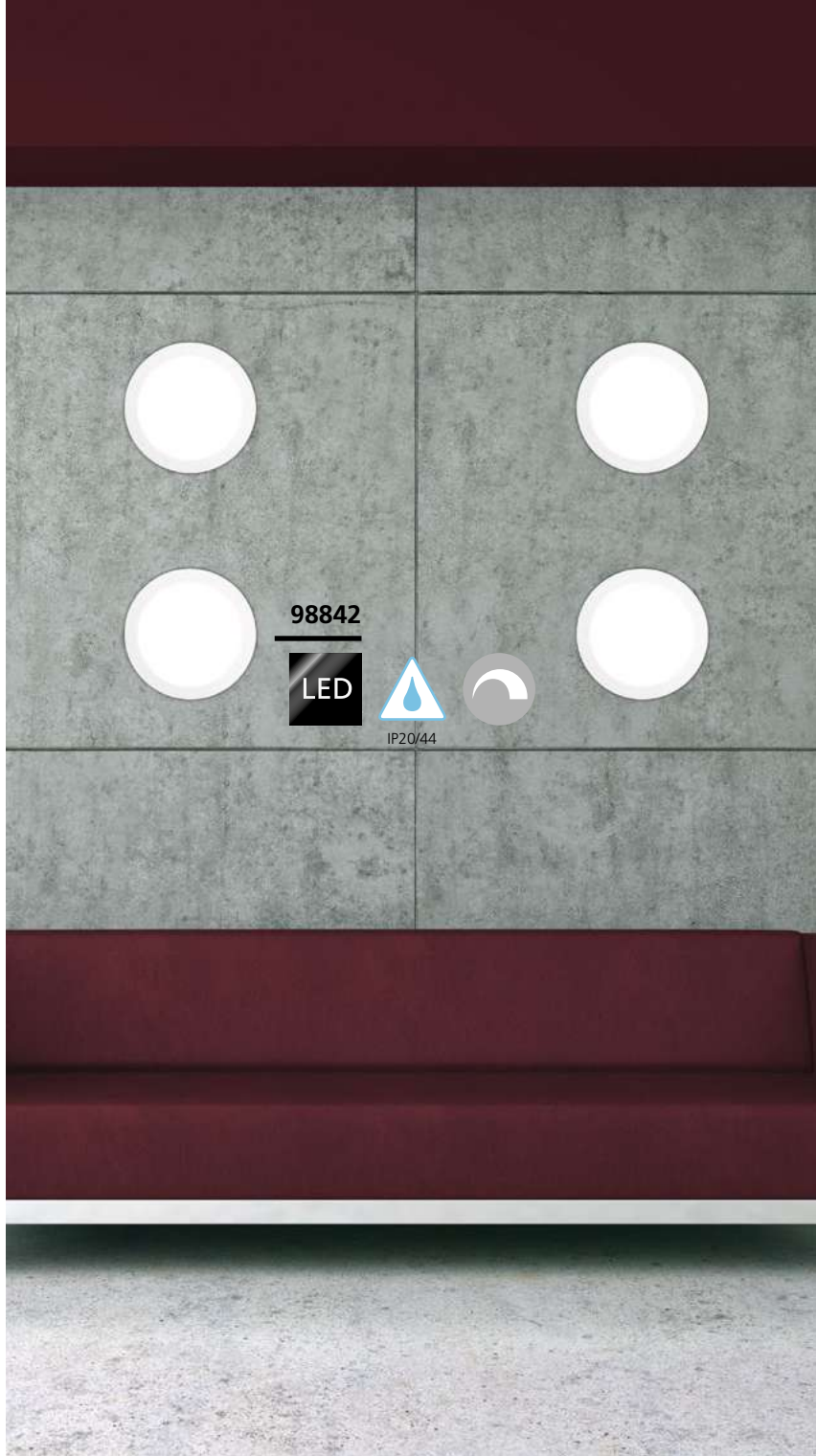

98842

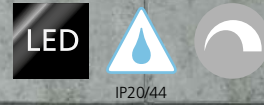

98842 FUEVA-Z

recessed light; aluminium, white / plastic, white
 Einbauleuchte; Alu, weiss / Kunststoff, weiss
 luminaire encastrable; aluminium, blanc / plastique, blanc

Ø 216, ET 26

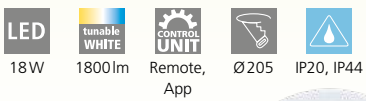



900111



IP20/44



900112



IP20/44



900113



IP20/44

900111 FUEVA-Z

recessed light; steel, satin nickel / plastic, white
Einbauleuchte; Stahl, nickel-matt / Kunststoff, weiss
luminaire encastrable; acier, nickel mat / plastique, blanc

H 26, Ø 85



3x 2,8W



3x 360lm



Remote, App



Ø 75



IP20, IP44



9 008606 225668



900112 FUEVA-Z

recessed light; steel, satin nickel / plastic, white
Einbauleuchte; Stahl, nickel-matt / Kunststoff, weiss
luminaire encastrable; acier, nickel mat / plastique, blanc

H 26, Ø 120



5,4W



600lm



Remote, App



Ø 105



IP20, IP44



9 008606 225675



900113 FUEVA-Z

recessed light; steel, satin nickel / plastic, white
Einbauleuchte; Stahl, nickel-matt / Kunststoff, weiss
luminaire encastrable; acier, nickel mat / plastique, blanc

H 26, Ø 165



10,8W



1250lm



Remote, App



Ø 155



IP20, IP44



9 008606 225682



Ø 165



98844

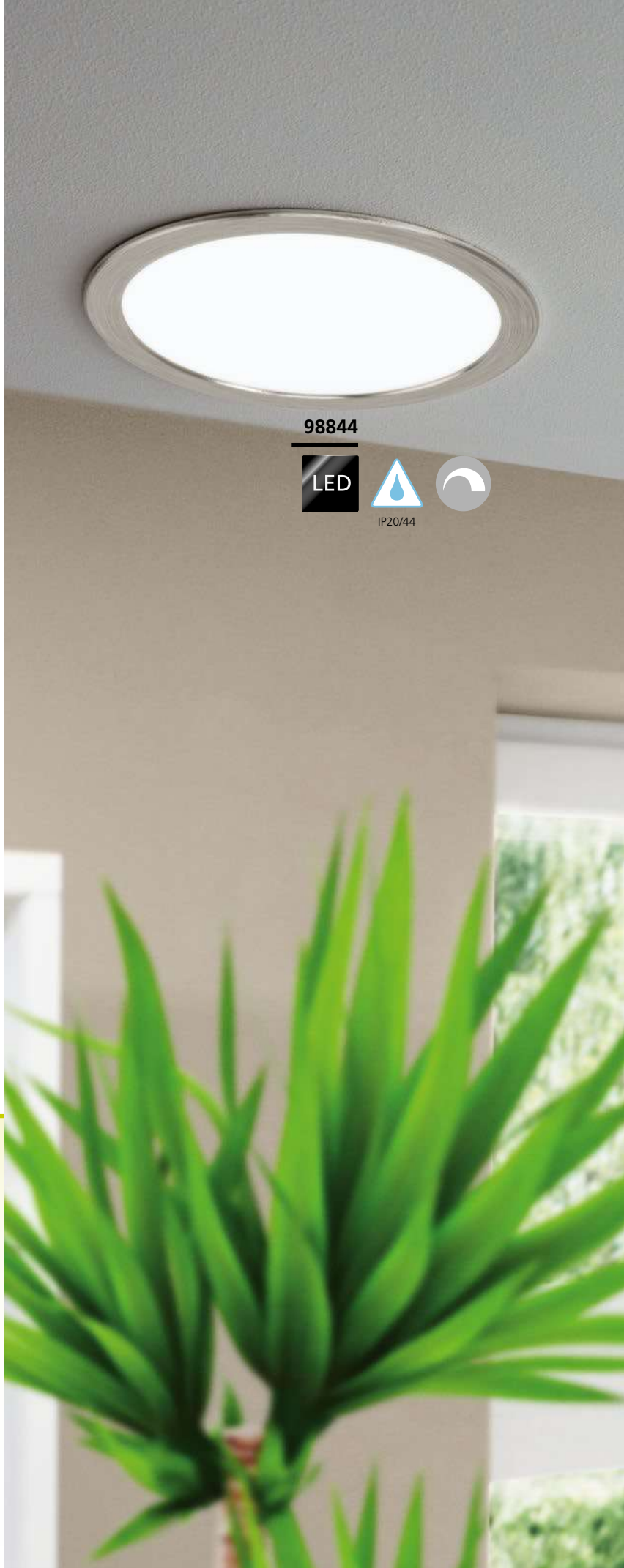

98844

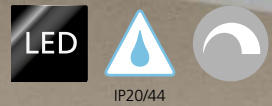

98844 FUEVA-Z

recessed light; aluminium, satin nickel / plastic, white
 Einbauleuchte; Alu, nickel-matt / Kunststoff, weiss
 luminaire encastrable; aluminium, nickel mat / plastique, blanc

Ø 216, ET 26

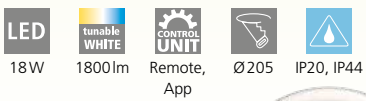

Ø 216





900105



IP20/44



900106



IP20/44



900107



IP20/44

900105 FUEVA-Z

recessed light; steel, black / plastic, white
Einbauleuchte; Stahl, schwarz / Kunststoff, weiss
luminaire encastrable; acier, noir / plastique, blanc

H 26, Ø 85

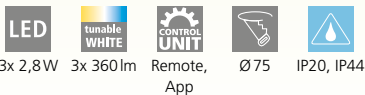

3x 2,8W 3x 360lm Remote, App Ø 75 IP20, IP44



9 008606 225613



Ø 85

H 26, Ø 120



5,4W 600lm Remote, App Ø 105 IP20, IP44



9 008606 225620



Ø 120

900106 FUEVA-Z

recessed light; steel, black / plastic, white
Einbauleuchte; Stahl, schwarz / Kunststoff, weiss
luminaire encastrable; acier, noir / plastique, blanc

H 26, Ø 166



10,8W 1250lm Remote, App Ø 155 IP20, IP44



9 008606 225637



Ø 166



98846



IP20/44



98846 FUEVA-Z

recessed light; aluminium, black / plastic, white
 Einbauleuchte; Alu, schwarz / Kunststoff, weiss
 luminaire encastrable; aluminium, noir / plastique, blanc

Ø 216, ET 26



18W



1800lm



Remote,
App



Ø205



IP20, IP44



Ø 216

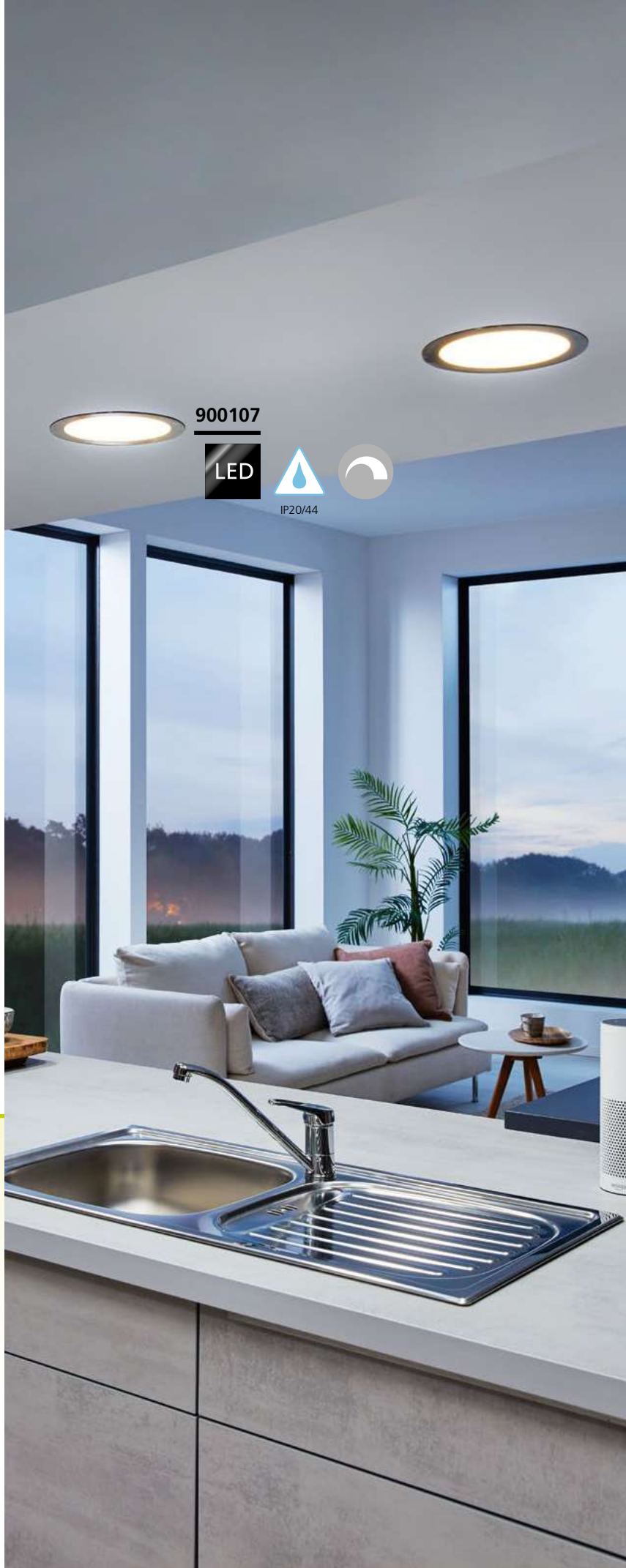

900107



IP20/44





900104



IP44



900103



IP44



98849



IP44

900104 FUEVA-Z

surface-mounted light; steel, white / plastic, white
Aufbauleuchte; Stahl, weiss / Kunststoff, weiss
luminaire en saillie; acier, blanc / plastique, blanc

L 210, B 210, H 28



16,5W



2100lm



Remote,
App



IP44



L 210

B 210

98849 FUEVA-Z

surface-mounted light; aluminium, white / plastic, white
Aufbauleuchte; Alu, weiss / Kunststoff, weiss
luminaire en saillie; aluminium, blanc / plastique, blanc

L 285, B 285, H 28



21W



2300lm



Remote,
App



IP44



L 285

B 285

900103 FUEVA-Z

surface-mounted light; steel, white / plastic, white
Aufbauleuchte; Stahl, weiss / Kunststoff, weiss
luminaire en saillie; acier, blanc / plastique, blanc

H 28, Ø 210



16,5W



2100lm



Remote,
App



IP44



Ø 210



9 008606 225606



9 002759 988494



9 008606 225590





98843



98843



98843 FUEVA-Z

surface-mounted light; aluminium, white / plastic, white
 Aufbauleuchte; Alu, weiss / Kunststoff, weiss
 luminaire en saillie; aluminium, blanc / plastique, blanc

H 28, Ø 285

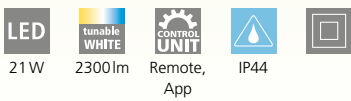



900114



900115



98845



900114 FUEVA-Z

surface-mounted light; steel, satin nickel / plastic, white
Aufbauleuchte; Stahl, nickel-matt / Kunststoff, weiss
luminaire en saillie; acier, nickel mat / plastique, blanc

98845 FUEVA-Z

surface-mounted light; aluminium, satin nickel / plastic, white
Aufbauleuchte; Alu, nickel-matt / Kunststoff, weiss
luminaire en saillie; aluminium, nickel mat / plastique, blanc

900115 FUEVA-Z

surface-mounted light; steel, satin nickel / plastic, white
Aufbauleuchte; Stahl, nickel-matt / Kunststoff, weiss
luminaire en saillie; acier, nickel mat / plastique, blanc

H 28, Ø 210



16,5W



2100lm



Remote, App



IP44



H 28, Ø 285



21W



2300lm



Remote, App



IP44



L 210, B 210, H 28



16,5W



2100lm



Remote, App



IP44



9 008606 225699



Ø 210



9 002759 988456



Ø 285



9 008606 225705



L 210





98852



IP44



98852



IP44

98852 FUEVA-Z

surface-mounted light; aluminium, satin nickel / plastic, white
Aufbauleuchte; Alu, nickel-matt / Kunststoff, weiss
luminaire en saillie; aluminium, nickel mat / plastique, blanc

L 285, B 285, H 28



21 W



2300 lm



Remote,
App



IP44



9 002759 988524





900108



98854



98847



900108 FUEVA-Z

surface-mounted light; steel, black / plastic, white
Aufbauleuchte; Stahl, schwarz / Kunststoff, weiss
luminaire en saillie; acier, noir / plastique, blanc

H 28, Ø 210

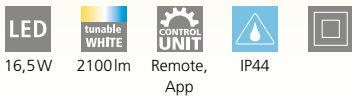

98847 FUEVA-Z

surface-mounted light; aluminium, black / plastic, white
Aufbauleuchte; Alu, schwarz / Kunststoff, weiss
luminaire en saillie; aluminium, noir / plastique, blanc

H 28, Ø 285

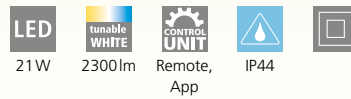

98854 FUEVA-Z

surface-mounted light; aluminium, black / plastic, white
Aufbauleuchte; Alu, schwarz / Kunststoff, weiss
luminaire en saillie; aluminium, noir / plastique, blanc

L 285, B 285, H 28

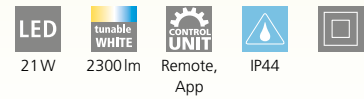

9 008606 225644



Ø 210



9 002759 988470



Ø 285



9 002759 988548



L 285





900109



IP44



900109



IP44

900109 FUEVA-Z

surface-mounted light; steel, black / plastic, white
Aufbauleuchte; Stahl, schwarz / Kunststoff, weiss
luminaire en saillie; acier, noir / plastique, blanc

L 210, B 210, H 28



16,5 W



2100 lm



Remote,
App



IP44



9 008606 225651

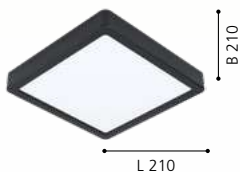



900088



900086



900089

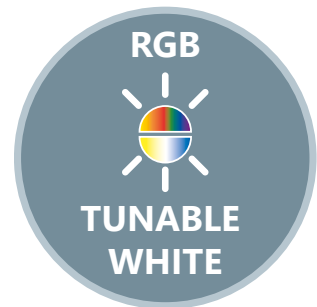

900088 ROVITO-Z

ceiling light; plastic, white / plastic, white
Deckenleuchte; Kunststoff, weiss / Kunststoff, weiss
plafonnier; plastique, blanc / plastique, blanc

L 295, B 295, H 25

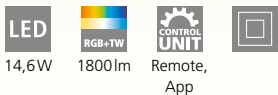

14,6W 1800lm Remote, App



9 008606 225491



L 295

900089 ROVITO-Z

ceiling light; plastic, white / plastic, white
Deckenleuchte; Kunststoff, weiss / Kunststoff, weiss
plafonnier; plastique, blanc / plastique, blanc

L 420, B 420, H 25



16,5W 2400lm Remote, App



9 008606 225507



L 420

900086 ROVITO-Z

ceiling light; plastic, white / plastic, white
Deckenleuchte; Kunststoff, weiss / Kunststoff, weiss
plafonnier; plastique, blanc / plastique, blanc

H 25, Ø 295



14,6W 1800lm Remote, App



9 008606 225477



Ø 295



900087



900087



900087 ROVITO-Z

ceiling light; plastic, white / plastic, white
Deckenleuchte; Kunststoff, weiss / Kunststoff, weiss
plafonnier; plastique, blanc / plastique, blanc

H 25, Ø 420



16,5 W



2400 lm



Remote,
App



9 008606 225484



Ø 420



900093



900091



900094

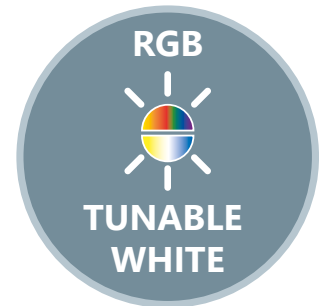

900093 ROVITO-Z

ceiling light; plastic, black / plastic, white
Deckenleuchte; Kunststoff, schwarz / Kunststoff, weiss
plafonnier; plastique, noir / plastique, blanc

L 295, B 295, H 25

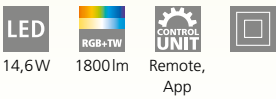

14,6W 1800lm Remote, App



9 008606 225538



900094 ROVITO-Z

ceiling light; plastic, black / plastic, white
Deckenleuchte; Kunststoff, schwarz / Kunststoff, weiss
plafonnier; plastique, noir / plastique, blanc

L 420, B 420, H 25

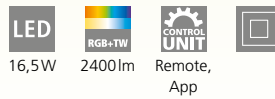

16,5W 2400lm Remote, App



9 008606 225545



900091 ROVITO-Z

ceiling light; plastic, black / plastic, white
Deckenleuchte; Kunststoff, schwarz / Kunststoff, weiss
plafonnier; plastique, noir / plastique, blanc

H 25, Ø 295

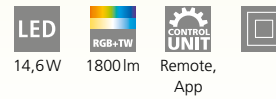

14,6W 1800lm Remote, App



9 008606 225514





900092



900091



900092 ROVITO-Z

ceiling light; plastic, black / plastic, white
Deckenleuchte; Kunststoff, schwarz / Kunststoff, weiss
plafonnier; plastique, noir / plastique, blanc

H 25, Ø 420



16,5 W



2400 lm



Remote,
App



9 008606 225521



Ø 420



99686

99687



99684

99685



99684, 99686, 99687

Driver included

Treiber inkludiert

Chauffeur inclus



1x 1,5 m

99865

Extension for starter set 99684 without driver

Erweiterung für Starterset 99684 ohne Treiber

Rallonge pour kit de démarrage 99684 sans pilote

99686 LED STRIPE-Z

bar / strip light; plastic, white
Leuchtband/-stab; Kunststoff, weiss
bande lumineuse / bâton l; plastique, blanc

L 5000, B 10

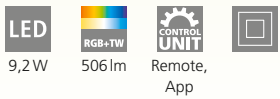

9,2W 506lm Remote, App

99687 LED STRIPE-Z

bar / strip light; plastic, white
Leuchtband/-stab; Kunststoff, weiss
bande lumineuse / bâton l; plastique, blanc

L 8000, B 12, H 3



24W 3200lm Remote, App

99684 LED STRIPE-Z

bar / strip light; plastic, white
Leuchtband/-stab; Kunststoff, weiss
bande lumineuse / bâton l; plastique, blanc

L 3000, B 8

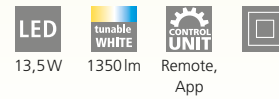

13,5W 1350lm Remote, App



9 002759 996864



L 5000



9 002759 996871



L 8000



9 002759 996840



L 3000



99687



99685 LED STRIPE-Z

bar / strip light; plastic, white
 Leuchtband/-stab; Kunststoff, weiss
 bande lumineuse / bâton l; plastique, blanc

L 2000, B 8



9W



900lm



Remote,
App



9 002759 996857



L 2000

EGLO Access

Let **light** follow
your **life**



OVERVIEW



ACCESS REMOTE
p. 52



SARSINA-A
p. 52



SARSINA-A
p. 52



SARSINA-A
p. 53



SALOBRENA-A
p. 54



SALOBRENA-A
p. 54



SALOBRENA-A
p. 54



SALOBRENA-A
p. 55



SALOBRENA-A
p. 55



FUEVA-A
p. 57



FUEVA-A
p. 57



FUEVA-A
p. 57



LED-STRIPE-A
p. 58



LED-STRIPE-A
p. 58



LET LIGHT FOLLOW YOUR LIFE

DAS LICHT, DAS SICH IHREM LEBEN ANPASST
LA LUMIÈRE QUE S'ADAPTE À VOTRE VIE



Light influences our lives and our work. For example, bright neutral white light improves focus, while warm, dimmed light makes us feel comfortable. You can adjust your EGLO Access luminaires to your requirements or mood.

- › One remote control for different light scenarios
- › 4-predefined settings
- › Tunable white: individually adjustable from warm white to cold white
- › Dimmable with incl. remote control
- › 2 memory functions for individual light

THE SYSTEM'S ADVANTAGES ARE:



Quick and simple installation



One remote control for up to 8 different items and a control distance up to 10 meters.



Light colour from 2700K to 6500K



No internet access necessary

Licht beeinflusst unser Leben und unsere Tätigkeiten. Zum Beispiel fördert helles, neutralweißes Licht die Konzentration, wohingegen warmes, gedimmtes Licht uns ein Gefühl von Behaglichkeit gibt. Je nach Anforderung oder Stimmung können Sie Ihre EGLO Access Leuchte individuell einstellen.

- › Eine Fernbedienung für verschiedene Lichtszenarien
- › 4 vordefinierte Einstellungen
- › Tunable white: individuell einstellbar von Warmweiß bis Kaltweiß
- › Dimmbar mit inkludierter Fernbedienung
- › 2 Speicherfunktionen für individuelles Licht

DIE VORTEILE DES SYSTEMS SIND:

Schnelle und einfache Installation

Eine Fernbedienung für bis zu 8 verschiedene Artikel und steuerbar bis zu 10 Meter

Lichtfarbe von 2700K bis 6500K

Kein Internetzugang erforderlich

La lumière influence nos vies et nos activités. Par exemple, une lumière blanche brillante et neutre favorise la concentration, tandis qu'une lumière chaude et atténuée nous procure une sensation de confort. En fonction de vos besoins ou de votre humeur, vous pouvez régler votre éclairage EGLO Access.

- › Une seule télécommande pour différents scénarios d'éclairage
- › 4 paramètres prédéfinis à l'emploi
- › Tunable white : réglable individuellement du blanc chaud au blanc froid
- › Graduable avec télécommande incluse
- › 2 fonctions mémoire pour un éclairage individuel

LES AVANTAGES DU SYSTÈME SONT :

Installation simple et rapide

Une seule télécommande pour jusqu'à 8 articles différents et contrôlable jusqu'à 10 mètres

Couleur de lumière de 2 700 K à 6 500 K

Aucun accès internet nécessaire

FUNCTIONS

FUNKTIONEN FONCTIONS

Relax with warm light and leave the hustle and bustle of everyday life behind you. Concentrate on your work or dispel fatigue, with neutral white light the energy level is replenished. EGLO Access offers these possibilities and many more. All functions and highlights at a glance:

› It works with radio frequency technology and allows 360 degree control

› Controllable up to a distance of 10 meters

› Up to 8 different items can be connected

› Easy handling thanks to 4 ready-made settings and 2 memory functions

NIGHT LIGHT

RELAX MODE

WORK MODE

SWITCH OFF AFTER 30 MINUTES

Mit warmem Licht entspannen und die Hektik des Alltages hinter sich lassen. Konzentriert arbeiten oder die Müdigkeit vertreiben, mit neutralweißem Licht wird das Energielevel wieder aufgefüllt. Diese Möglichkeiten und noch viele mehr bietet Ihnen EGLO Access. Alle Funktionen und Highlights auf einem Blick:

› Es arbeitet mit Funktechnologie und ermöglicht eine 360-Grad-Steuerung

› Steuerbar bis zu einer Entfernung von 10 Metern

› Bis zu 8 verschiedene Artikel können miteinander verbunden werden

› Einfache Handhabung durch 4 vorgefertigte Einstellungen und 2 Speicherfunktionen

NACHTLICHT

ENTSPANNUNGSMODUS

ARBEITSMODUS

AUSSCHALTEN NACH 30 MINUTEN

Lumière chaude pour se détendre et laisser l'agitation quotidienne derrière soi. Travailler de manière concentrée ou chasser la fatigue, avec une lumière blanche neutre, le niveau d'énergie est rétabli. EGLO Access vous offre ces possibilités et bien d'autres encore. Toutes les fonctions et les points forts en un coup d'œil :

› Il fonctionne avec la technologie de la fréquence radio et permet un contrôle à 360 degrés

› Contrôlable jusqu'à une distance de 10 mètres

› Jusqu'à 8 articles différents peuvent être connectés ensemble

› Manipulation facile grâce à 4 réglages prêts à l'emploi et 2 fonctions mémoire

VEILLEUSE

MODE DE DÉCOMPRESSION

MODE DE TRAVAIL

EXTINCTION APRÈS 30 MINUTES

COLOUR TEMPERATURES SCALE / FARBTTEMPERATUREN SKALA / ÉCHELLE DES TEMPÉRATURES DE COULEUR



2700K

3000K

4500K

6500K

WARM WHITE

NEUTRAL WHITE

DAY LIGHT

REMOTE CONTROL

FERNBEDIENUNG
TÉLÉCOMMANDE

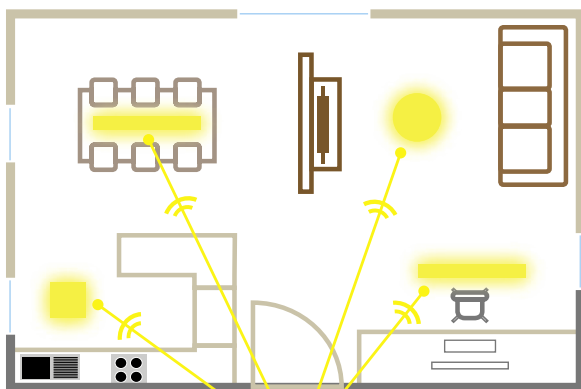

no internet necessary
kein Internet erforderlich
nul besoin d'internet



Control up to 8 EGLO Access luminaires
Bis zu 8 EGLO Access Leuchten steuerbar
Contrôle jusqu'à 8 luminaires EGLO Access



98207

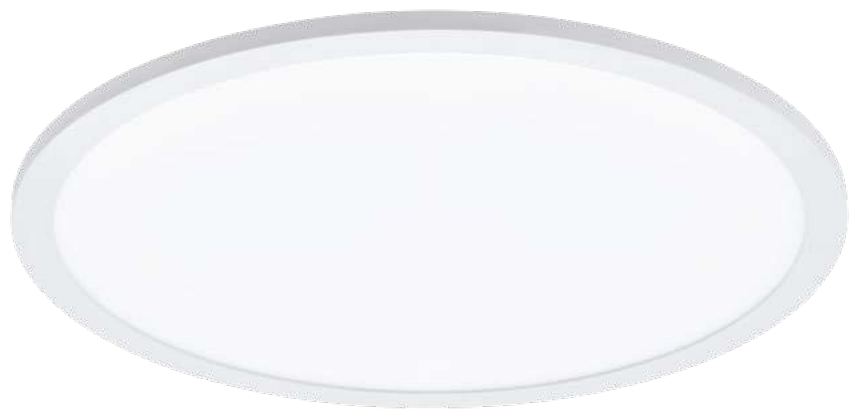

98208



33199

33199 ACCESS REMOTE

remote control; plastic, anthracite
Fernbedienung; Kunststoff, anthrazit
Télécommande; plastique, anthracite

L 118, B 45



CR2032

98207 SARSINA-A

ceiling light; aluminium, white / plastic, white
Deckenleuchte; Alu, weiss / Kunststoff, weiss
plafonnier; aluminium, blanc / plastique, blanc

H 50, Ø 300



14W



2000lm



remote



98208 SARSINA-A

ceiling light; aluminium, white / plastic, white
Deckenleuchte; Alu, weiss / Kunststoff, weiss
plafonnier; aluminium, blanc / plastique, blanc

H 50, Ø 450



19,5W



2750lm



remote



9 002759 331993



B 45

L 118



9 002759 982072



Ø 300



9 002759 982089



Ø 450

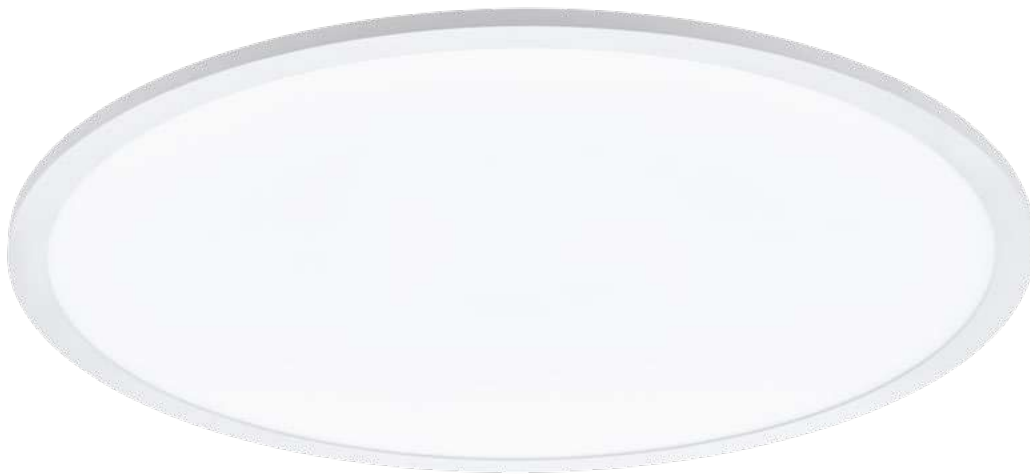

98209



98209



98209 SARSINA-A

ceiling light; aluminium, white / plastic, white
Deckenleuchte; Alu, weiss / Kunststoff, weiss
plafonnier; aluminium, blanc / plastique, blanc

H 50, Ø 600



30W



4000lm



remote



9 002759 982096



Ø 600



98201

LED

incl./inkl./inclus 



98297

LED

incl./inkl./inclus 



98203

LED

incl./inkl./inclus 

98201 SALOBRENA-A

ceiling light; aluminium, white / plastic, white
Deckenleuchte; Alu, weiss / Kunststoff, weiss
plafonnier; aluminium, blanc / plastique, blanc

L 300, B 300, H 50



98297 SALOBRENA-A

ceiling light; aluminium, white / plastic, white
Deckenleuchte; Alu, weiss / Kunststoff, weiss
plafonnier; aluminium, blanc / plastique, blanc

L 450, B 450, H 50



98203 SALOBRENA-A

ceiling light; aluminium, white / plastic, white
Deckenleuchte; Alu, weiss / Kunststoff, weiss
plafonnier; aluminium, blanc / plastique, blanc

L 600, B 600, H 50



9 002759 982010



9 002759 982973



9 002759 982034





98205

LED



98206

LED



98205 SALOBRENA-A

ceiling light; aluminium, white / plastic, white
Deckenleuchte; Alu, weiss / Kunststoff, weiss
plafonnier; aluminium, blanc / plastique, blanc

L 1200, B 300, H 50



98206 SALOBRENA-A

ceiling light; aluminium, white / plastic, white
Deckenleuchte; Alu, weiss / Kunststoff, weiss
plafonnier; aluminium, blanc / plastique, blanc

L 1195, B 100, H 50

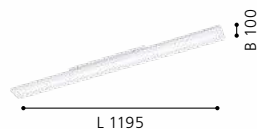
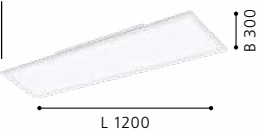



98212

LED

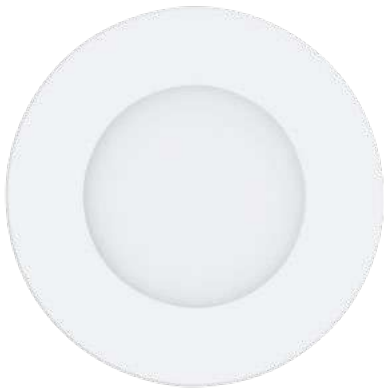

98212

LED

incl./inkl./inclus



98292

LED

incl./inkl./inclus



98293

LED

incl./inkl./inclus



98212 FUEVA-A

recessed light; aluminium, white / plastic, white
Einbauleuchte; Alu, weiss / Kunststoff, weiss
luminaire encastrable; aluminium, blanc / plastique, blanc

Ø 120, ET 30

LED

5W

tunable
WHITE

700lm



CONTROL
UNIT

remote



Ø 108



9 002759 982126



RECESSED



Ø 120

H 30, Ø 225

LED

14W

tunable
WHITE

2000lm



CONTROL
UNIT

remote



9 002759 982928



SURFACE



Ø 225

H 30, Ø 300

LED

20W

tunable
WHITE

2650lm



CONTROL
UNIT

remote



9 002759 982935



SURFACE



Ø 300



98295



98296



98295, 98296

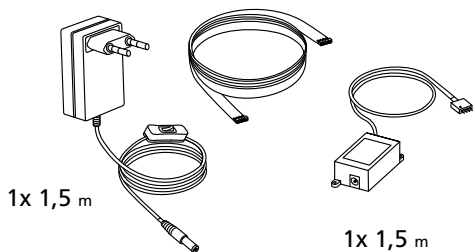

1x 1,5 m

1x 1,5 m

98295, 98296

These articles include a remote control.

Bei diesen Artikeln ist eine Fernbedienung inkludiert.

Ces articles comprennent une télécommande.

98295 LED-STRIPE-A

bar / strip light; plastic, white
 Leuchtband/-stab; Kunststoff, weiss
 bande lumineuse / bâton l; plastique, blanc

L 2000, B 10, H 3



9W

950lm

remote

98296 LED-STRIPE-A

bar / strip light; plastic, white
 Leuchtband/-stab; Kunststoff, weiss
 bande lumineuse / bâton l; plastique, blanc

L 5000, B 10, H 3



17W

1800lm

remote

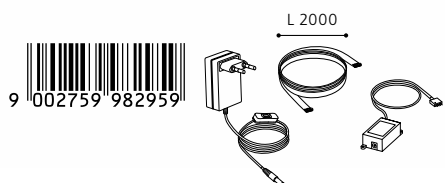

9 002759 982959

L 2000

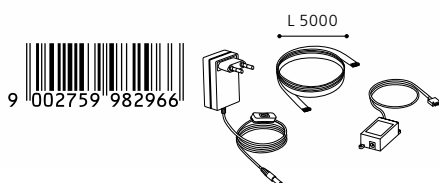

9 002759 982966

L 5000



98296





RECESSED & **SURFACE** LUMINAIRES

EMPHASIZE THE FEATURES

EMPHASIZE THE FEATURES - DISCREET IN THE APPEARANCE, PERFECTION IN STAGING. INSTEAD OF PUTTING THEMSELVES IN SCENE, THE RECESSED & SURFACE MOUNTED LUMINAIRES ARE HIGHLIGHTING YOUR LIVING AREA. THEY CONVINCED WITH THEIR UNCOMPLICATED APPLICATION AND DUE TO THE USE OF LED-PLATES AND LED-ILLUMINANTS THEY ARE POWER- AND COST-SAVING.

VORTEILE

DEZENT IM AUFTRETEN, PERFEKT IN DER INSZENIERUNG. UNSERE EIN- UND AUFBAULEUCHTEN SETZEN NICHT SICH SELBST, SONDERN IHR ZUHAUSE IN SZENE. SIE ÜBERZEUGEN MIT IHRER UNKOMPLIZIERTEN ANWENDUNG UND SIND AUFGRUND DER LED-PLATINEN UND LED-LEUCHTMITTEL STROM- UND KOSTENSPAREND.

AVANTAGES

DISCRET EN APPARENCE - PARFAIT DANS LA MIS EN SCÈNE. NOS LUMINAIRES ENCASTRÉES ET EN SAILLIE NE METTENT PAS EUX-MÊMES EN SCÈNE, MAIS VOTRE MAISON. ILS IMPRESSIONNENT PAR LEUR APPLICATION SIMPLE. EN PLUS, ILS RÉDUISENT LES COÛTS ET LE BESOIN D'ÉNERGIE GRÂCE AUX PLATINES ET LAMPES À LED.



LED PANEL FUNCTION

Item Number Artikelnummer Numéro d'article	Series name Seriennamen Nom de la série	Dimensions Größe Dimensions	Page Seite Page	warm white warmweiß blanc chaud	neutral white neutralweiß blanc neutre	dimmmable dimmmbar gradable
99841	LAZARAS	Ø 450	67	•	•	•
99842	LAZARAS	L 450, B 450	67	•	•	•
32811	SALOBRENA 1	L 1200, B 300, H 50	89		•	
32812	SALOBRENA 1	L 300, B 300, H 50	88		•	
32813	SALOBRENA 1	L 595, B 595, H 50	89		•	
96151	SALOBRENA 1	L 1200, B 300, H 11	71		•	
96152	SALOBRENA 1	L 300, B 300, H 11	70		•	
96153	SALOBRENA 1	L 595, B 595, H 11	70		•	
96154	SALOBRENA 1	L 620, B 620, H 11	70		•	
98025	SALOBRENA 1	L 1195, B 100, H 45	89		•	
98129	SALOBRENA 1	L 450, B 450, H 50	88		•	
98418	SALOBRENA-M	L 595, B 595, H 50	90		•	
98419	SALOBRENA-M	L 1195, B 295, H 50	90		•	
33107	SALOBRENA-RGBW	L 450, B 450, H 11	96	•	•	•
33108	SALOBRENA-RGBW	L 600, B 300, H 11	96	•	•	•
97501	SARSINA	H 50, Ø 300	94		•	•
97502	SARSINA	H 50, Ø 450	94		•	•
97503	SARSINA	H 50, Ø 600	94		•	•
98485	SARSINA	H 50, Ø 800	95		•	•
99038	SAVATARILA	L 450, B 450, H 60	66		•	
99039	SAVATARILA	L 595, B 595, H 60	66		•	
98475	TURCONA	L 300, B 300, H 60	78	•		
98476	TURCONA	L 450, B 450, H 60	78	•		
98477	TURCONA	L 595, B 595, H 60	78	•		
98478	TURCONA	L 1200, B 300, H 60	79	•		
98479	TURCONA	L 1200, B 100, H 60	79	•		
98901	TURCONA	L 300, B 300, H 60	80		•	
98902	TURCONA	L 450, B 450, H 60	80		•	
98903	TURCONA	L 595, B 595, H 60	80		•	
98904	TURCONA	L 1200, B 300, H 60	81		•	
98905	TURCONA	L 1200, B 100, H 60	81		•	
99843	TURCONA-B	L 287, B 287, H 62	82	•		
99844	TURCONA-B	L 437, B 437, H 70	83	•		
99845	TURCONA-B	L 587, B 587, H 70	83	•		
99846	TURCONA-B	L 1187, B 287, H 70	83	•		
99833	TURCONA-CCT	L 287, B 287, H 62	84	•	•	•
99834	TURCONA-CCT	L 437, B 437, H 70	85	•	•	•
99835	TURCONA-CCT	L 587, B 587, H 70	85	•	•	•
99836	TURCONA-CCT	L 1187, B 287, H 70	85	•	•	•
99728	URTEBIETA	L 595, B 595, H 38	74		•	
99729	URTEBIETA	L 1195, B 295, H 38	74		•	



LED PANEL LUMINAIRES

DECORATIVE

ADVANTAGES

- > ULTRA-FLAT DESIGN
 - > HOMOGENEOUS SURFACE LIGHTING
 - > SIMPLE AND FAST INSTALLATION
 - > DECORATIVE DOMESTIC LIGHTING
 - > WALL AND CEILING LIGHTING
-

VORTEILE

- > ULTRAFLACHES DESIGN
 - > HOMOGENE LICHTVERTEILUNG
 - > EINFACHE UND SCHNELLE MONTAGE
 - > DEKORATIVE WOHNBELEUCHTUNG
 - > WAND- UND DECKENBELEUCHTUNG
-

AVANTAGES

- > DESIGN ULTRA PLAT
- > ÉCLAIRAGE DE SURFACE HOMOGENÈ
- > MONTAGE SIMPLE ET RAPIDE
- > ÉCLAIRAGE DOMESTIQUE DÉCORATIF
- > ÉCLAIRAGE MURAL ET PLAFONNIER

OVERVIEW

5 year warranty
Jahre Garantie
ans de garantie
anni di garanzia
años de garantía
anos de garantía



SAVATARILA
p. 66



SAVATARILA
p. 66



LAZARAS
p. 67



LAZARAS
p. 67





99038



99039



99038 SAVATARILA

ceiling light; aluminium, black / plastic, white
Deckenleuchte; Alu, schwarz / Kunststoff, weiss
plafonnier; aluminium, noir / plastique, blanc

L 450, B 450, H 60



24W 2900lm

99039 SAVATARILA

ceiling light; aluminium, black / plastic, white
Deckenleuchte; Alu, schwarz / Kunststoff, weiss
plafonnier; aluminium, noir / plastique, blanc

L 595, B 595, H 60



36W 4600lm



9 002759 990381

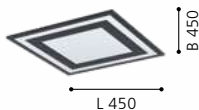

9 002759 990398

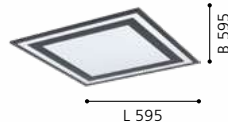



99842



incl./inkl./inclus



99841

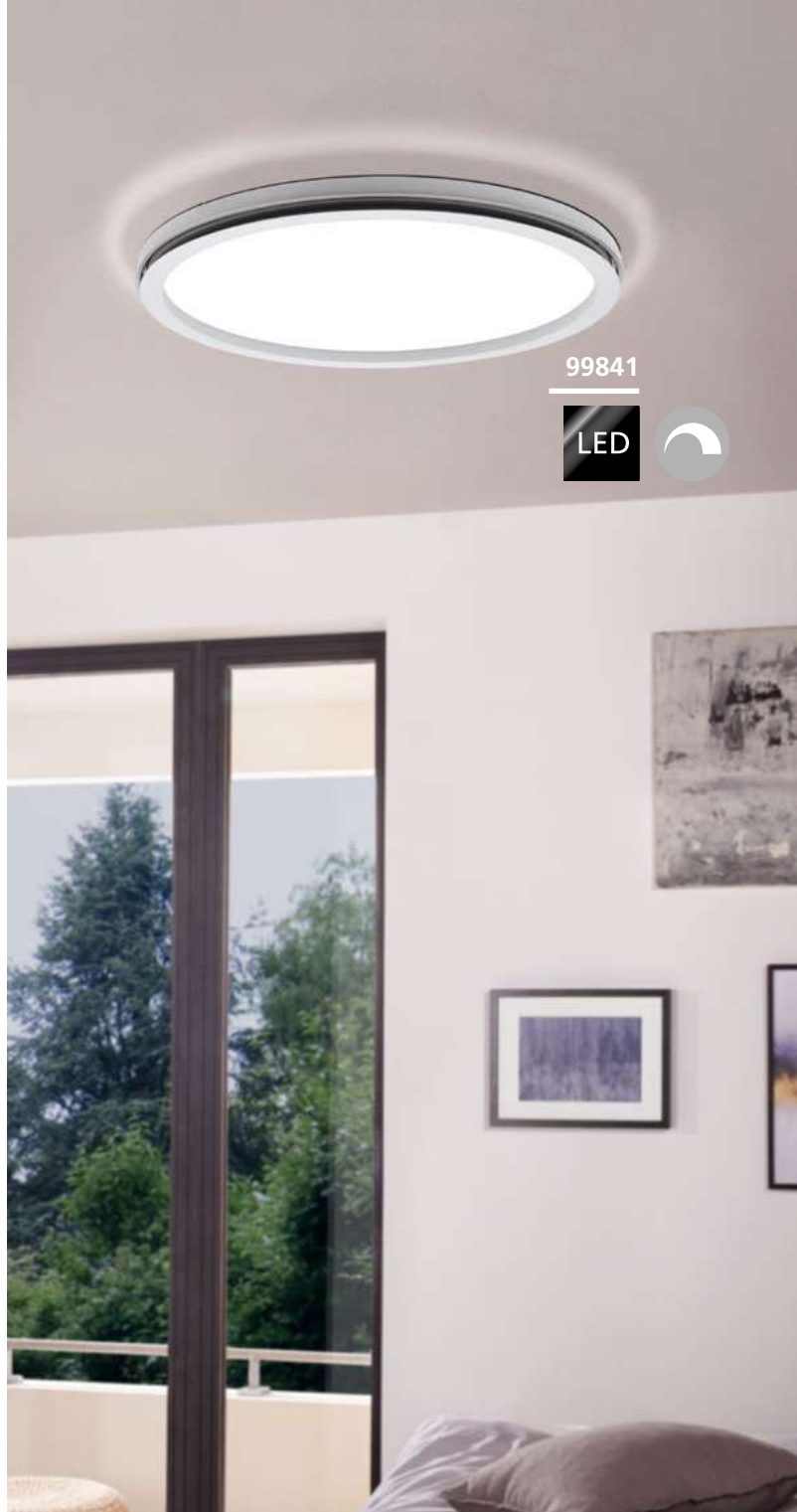

incl./inkl./inclus

99841



99842 LAZARAS

ceiling light; aluminium, steel, white / plastic, white
 Deckenleuchte; Alu, Stahl, weiss / Kunststoff, weiss
 plafonnier; aluminium, acier, blanc / plastique, blanc

L 450, B 450



99841 LAZARAS

ceiling light; aluminium, steel, white / plastic, white
 Deckenleuchte; Alu, Stahl, weiss / Kunststoff, weiss
 plafonnier; aluminium, acier, blanc / plastique, blanc

Ø 450



9 002759 998424



9 002759 998417





LED PANEL LUMINAIRES

BASIC

ADVANTAGES

- > SLIM DESIGN WITH 6 MOUNTING OPTIONS
 - > UNIFORM DISTRIBUTION OF LIGHT - IDEAL FOR ILLUMINATING SPACES AND SURFACES
 - > LOW TEMPERATURE ENHANCES SAFETY
 - > UP TO 80% POWER SAVINGS COMPARED TO INCANDESCENT LAMPS, SAVES YOUR BUDGET AND TAKES CARE OF THE ENVIRONMENT
-

VORTEILE

- > SCHLANKE BAUFORM MIT 6 MONTAGEVARIANTEN
 - > HOMOGENE LICHTVERTEILUNG - IDEAL ZUR BELEUCHTUNG VON RÄUMEN UND FLÄCHEN
 - > GERINGE WÄRMEENTWICKLUNG SORGT FÜR MEHR SICHERHEIT
 - > BIS ZU 80% STROMERSPARNIS GEGENÜBER GLÜHLAMPEN, SCHONT IHR BUDGET UND DIE UMWELT
-

AVANTAGES

- > CONCEPTION MINCE AVEC 6 OPTIONS DE MONTAGE
- > DISTRIBUTION UNIFORME DE LA LUMIÈRE - IDÉAL POUR L'ILLUMINATION DES ESPACES ET SURFACES
- > FAIBLE CHALEUR AMÉLIORE LA SÉCURITÉ
- > JUSQU'À 80% D'ÉCONOMIES D'ÉNERGIE PAR RAPPORT AUX LAMPES À INCANDESCENCE, RÉDUIT VOTRE BUDGET ET PROTÈGE L'ENVIRONNEMENT

OVERVIEW

5 year warranty
Jahre Garantie
ans de garantie
anni di garanzia
años de garantía
anos de garantía



MOUNTING MATERIAL INCLUDED

Montagezubehör inkludiert
matériel de montage inclus

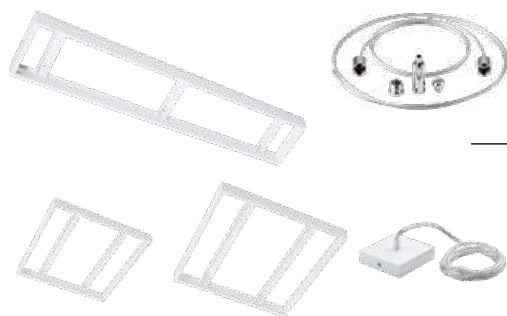

ACCESSORIES OPTIONAL

PAGE / SEITE / PAGE **72-73**



96153



96152



96154



96152 SALOBRENA 1

grid light; aluminium, white / plastic, white
Rasterleuchte; Alu, weiss / Kunststoff, weiss
luminaire à grille; aluminium, blanc / plastique, blanc

96153 SALOBRENA 1

grid light; aluminium, white / plastic, white
Rasterleuchte; Alu, weiss / Kunststoff, weiss
luminaire à grille; aluminium, blanc / plastique, blanc

96154 SALOBRENA 1

grid light; aluminium, white / plastic, white
Rasterleuchte; Alu, weiss / Kunststoff, weiss
luminaire à grille; aluminium, blanc / plastique, blanc

L 300, B 300, H 11



16W 2100lm

L 595, B 595, H 11



40W 4300lm

L 620, B 620, H 11



40W 4100lm



9 002759 961527



9 002759 961534



9 002759 961541





96151



MOUNTING WITH INCLUDED MATERIAL

MONTAGE MIT INKLUDIERTEM MONTAGEMATERIAL
MONTAGE AVEC MATÉRIEL DE MONTAGE INCLUS



**1 GRID LUMINAIRE
RASTERLEUCHTE
LUMINAIRE À GRILLE**

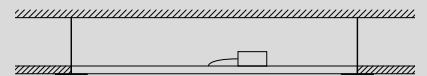

**2 RECESSED LUMINAIRE
EINBAULEUCHTE
LUMINAIRE ENCASTRÉE**



**3 SEMI-RECESSED LUMINAIRE
SEMI-EINBAULEUCHTE
LUMINAIRE SEMI-ENCASTRÉE**

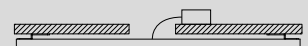

**4 SURFACE LUMINAIRE
AUFBAULEUCHTE
LUMINAIRE EN SAILLIE**

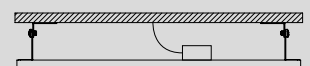

96151 SALOBRENA 1

grid light; aluminium, white / plastic, white
Rasterleuchte; Alu, weiss / Kunststoff, weiss
luminaire à grille; aluminium, blanc / plastique, blanc

L 1200, B 300, H 11

LED

40W

neutral
WHITE

5500lm





61489



61355

61489 SALOBRENA 1

accessory; steel, white
Zubehör; Stahl, weiss
accessoire; acier, blanc

L 95, B 95, H 2000

61355 SALOBRENA 1

accessory; steel, chrome
Zubehör; Stahl, chrom
accessoire; acier, chrome

L 900

61358 SALOBRENA 1

accessory; steel, white
Zubehör; Stahl, weiss
accessoire; acier, blanc

L 603, B 603, H 50

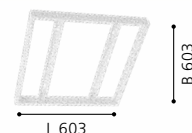
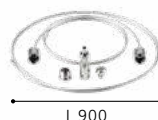

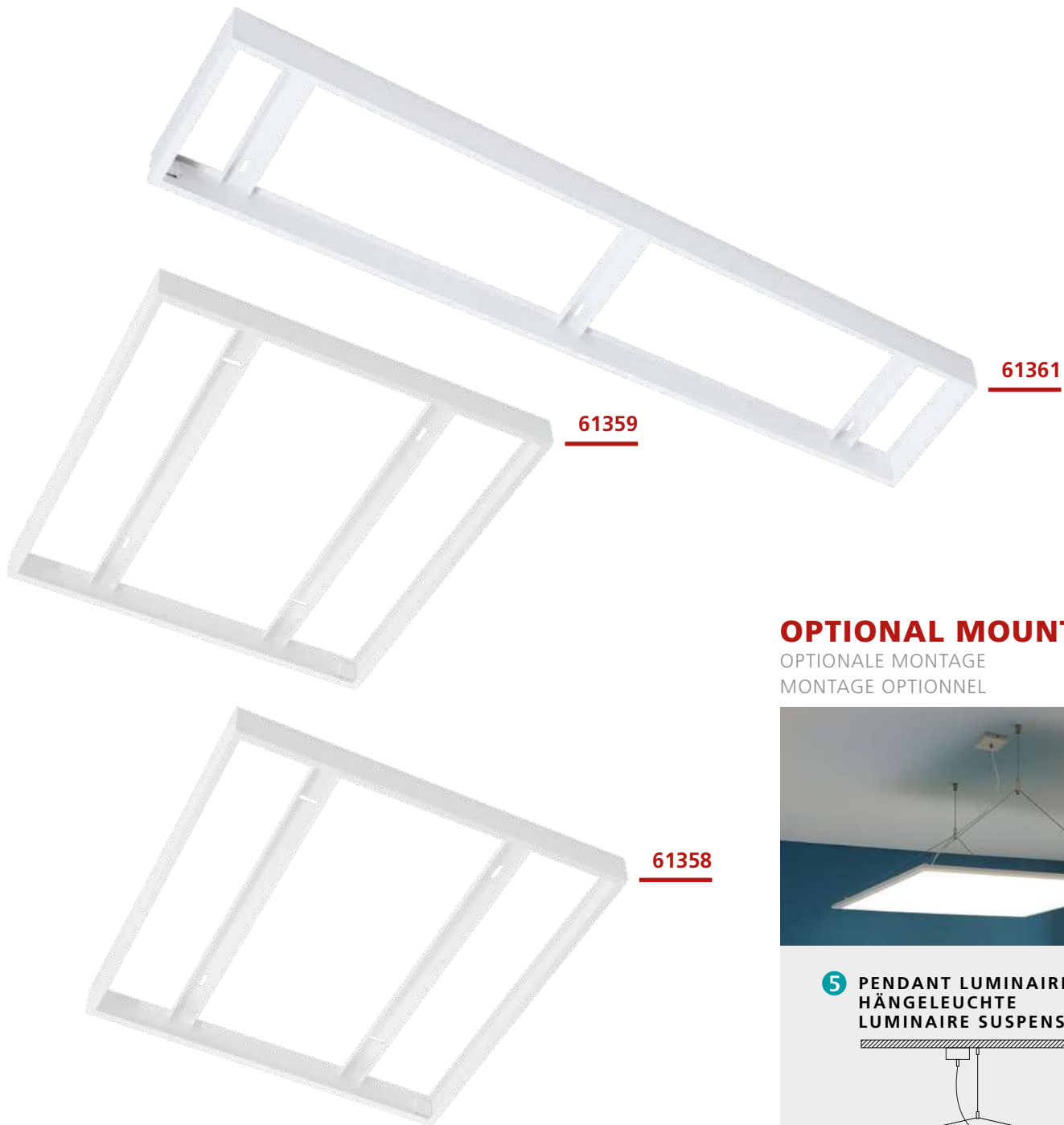

OPTIONAL MOUNTING

OPTIONALE MONTAGE
MONTAGE OPTIONNEL



5 PENDANT LUMINAIRE HÄNGELEUCHE LUMINAIRE SUSPENSION

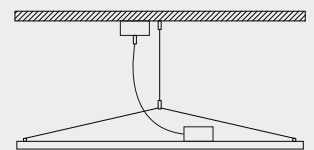

6 FRAME SURFACE LUMINAIRE RAHMEN AUFBAULEUCHE LUMINAIRE EN SAILLIE AVEC BOX

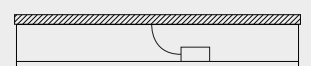

61359 SALOBRENA 1

accessory; steel, white
Zubehör; Stahl, weiss
accessoire; acier, blanc

L 627, B 628, H 50



9 002759 613594



L 627

B 628

61361 SALOBRENA 1

accessory; steel, white
Zubehör; Stahl, weiss
accessoire; acier, blanc

L 303, B 1205, H 50



9 002759 613617



B 1205

L 303



99728



99729



99729

Due to its reduced glare effect, this luminaire is very well suited for the home office.

Diese Leuchte ist aufgrund ihres reduzierten Blendeffekts sehr gut für das Homeoffice geeignet.

En raison de son effet d'éblouissement réduit, ce luminaire est très bien adapté au bureau à domicile.

99728 URTEBIETA

ceiling light; steel, white / plastic, white
Deckenleuchte; Stahl, weiss / Kunststoff, weiss
plafonnier; acier, blanc / plastique, blanc

L 595, B 595, H 50



99729 URTEBIETA

ceiling light; steel, white / plastic, white
Deckenleuchte; Stahl, weiss / Kunststoff, weiss
plafonnier; acier, blanc / plastique, blanc

L 1195, B 295, H 50



9 002759 997281



9 002759 997298





99729

LED





LED PANEL LUMINAIRES

FRAMELESS

ADVANTAGES

- > THE ENTIRE BODY OF THE PANEL IS UTILIZED AS LIGHT SOURCE
 - > ULTRA-FLAT DESIGN
 - > HOMOGENEOUS SURFACE LIGHTING
 - > SIMPLE AND FAST INSTALLATION
 - > ELEGANT SUSPENSION FRAME INCLUDED
 - > DECORATIVE DOMESTIC LIGHTING
 - > WALL AND CEILING LIGHTING
-

VORTEILE



















- > DER GESAMTE LEUCHTKÖRPER DIENT ALS LEUCHTFLÄCHE
 - > ULTRAFLACHES DESIGN
 - > HOMOGENE LICHTVERTEILUNG
 - > EINFACHE UND SCHNELLE MONTAGE
 - > INKL. ELEGANTEM SCHWEBERAHMEN
 - > DEKORATIVE WOHNBELEUCHTUNG
 - > WAND- UND DECKENBELEUCHTUNG
-

AVANTAGES

- > LE CORPS ENTIER DU PANNEAU EST UTILISÉ COMME SOURCE DE LUMIÈRE
 - > DESIGN ULTRA PLAT
 - > ÉCLAIRAGE DE SURFACE HOMOGENÈ
 - > MONTAGE SIMPLE ET RAPIDE
 - > BÂTI FLOTTANT ÉLÉGANT INCLUS
 - > ÉCLAIRAGE DOMESTIQUE DÉCORATIF
 - > ÉCLAIRAGE MURAL ET PLAFONNIER
- 

OVERVIEW

5 year warranty
 Jahre Garantie
 ans de garantie
 anni di garanzia
 años de garantía
 anos de garantia

							
TURCONA* p.78	TURCONA* p.78	TURCONA* p.78	TURCONA* p.79	TURCONA p.79	TURCONA* p.80	TURCONA* p.80	TURCONA* p.80
							
TURCONA* p.81	TURCONA p.81	TURCONA-B* p.82	TURCONA-B* p.83	TURCONA-B* p.83	TURCONA-B* p.83	TURCONA-CCT* p.84	TURCONA-CCT* p.85
							
TURCONA-CCT* p.85	TURCONA-CCT* p.85						



98475, 98901
white



98477, 98903
white



98476, 98902
white



98478, 98904
white

ACCESSORIES INCLUDED*

Suspension frame for
 Schweberahmen für
 Bâti flottant pour



98475



98476

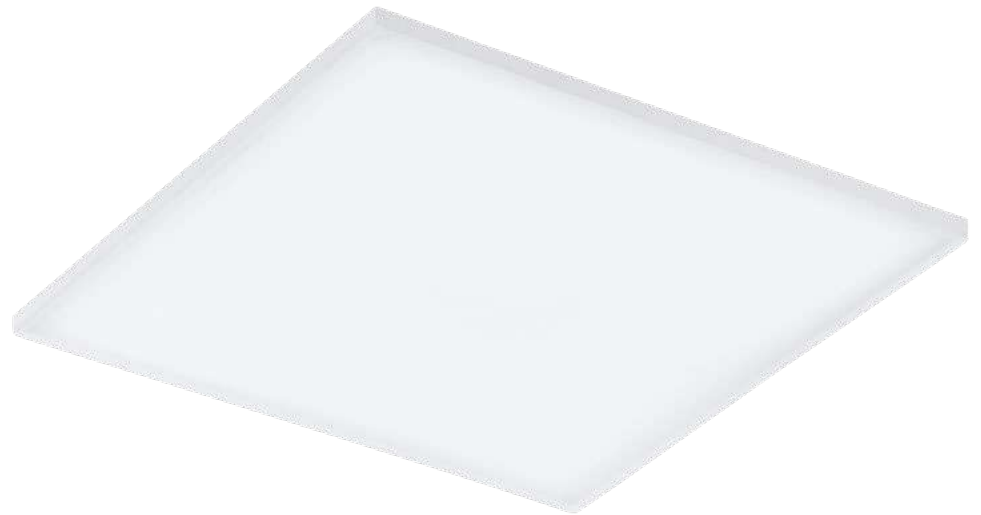

98477



TURCONA

These luminaires have an edgelight technology.

Diese Leuchten verfügen über eine Edgelight Technology.

Ces luminaires sont équipés d'une technologie edgelight.

98475 TURCONA

ceiling light; steel, white / plastic, satiné
Deckenleuchte; Stahl, weiss / Kunststoff, satiniert
plafonnier; acier, blanc / plastique, satiné

L 300, B 300, H 60



11W 1300lm



9 002759 984755



98476 TURCONA

ceiling light; steel, white / plastic, satiné
Deckenleuchte; Stahl, weiss / Kunststoff, satiniert
plafonnier; acier, blanc / plastique, satiné

L 450, B 450, H 60



20W 2400lm



9 002759 984762

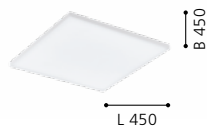

98477 TURCONA

ceiling light; steel, white / plastic, satiné
Deckenleuchte; Stahl, weiss / Kunststoff, satiniert
plafonnier; acier, blanc / plastique, satiné

L 595, B 595, H 60



33W 3800lm



9 002759 984779

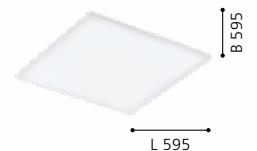



98478



98479



98478 TURCONA

ceiling light; steel, white / plastic, satiné
 Deckenleuchte; Stahl, weiss / Kunststoff, satiniert
 plafonnier; acier, blanc / plastique, satiné

L 1200, B 300, H 60



33W 3800lm

98479 TURCONA

ceiling light; steel, white / plastic, satiné
 Deckenleuchte; Stahl, weiss / Kunststoff, satiniert
 plafonnier; acier, blanc / plastique, satiné

L 1200, B 100, H 60



20W 2600lm



9 002759 984786



9 002759 984793

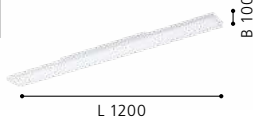



98901



98902



98903



TURCONA

These luminaires have an edgelight technology.

Diese Leuchten verfügen über eine Edgelight Technology.

Ces luminaires sont équipés d'une technologie edgelight.

98901 TURCONA

ceiling light; steel, white / plastic, satined
Deckenleuchte; Stahl, weiss / Kunststoff, satiniert
plafonnier; acier, blanc / plastique, satiné

L 300, B 300, H 60



11W 1400lm



9 002759 989019



98902 TURCONA

ceiling light; steel, white / plastic, satined
Deckenleuchte; Stahl, weiss / Kunststoff, satiniert
plafonnier; acier, blanc / plastique, satiné

L 450, B 450, H 60



20W 2600lm



9 002759 989026

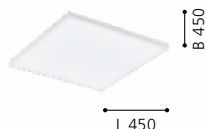

98903 TURCONA

ceiling light; steel, white / plastic, satined
Deckenleuchte; Stahl, weiss / Kunststoff, satiniert
plafonnier; acier, blanc / plastique, satiné

L 595, B 595, H 60



33W 4200lm



9 002759 989033

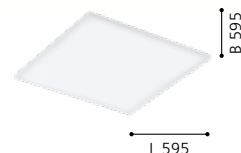



98904



98905



98904 TURCONA

ceiling light; steel, white / plastic, satined
Deckenleuchte; Stahl, weiss / Kunststoff, satiniert
plafonnier; acier, blanc / plastique, satiné

L 1200, B 300, H 60



33W 4200lm



9 002759 989040

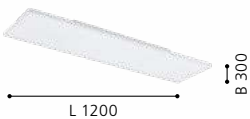

98905 TURCONA

ceiling light; steel, white / plastic, satined
Deckenleuchte; Stahl, weiss / Kunststoff, satiniert
plafonnier; acier, blanc / plastique, satiné

L 1200, B 100, H 60



20W 2900lm



9 002759 989057

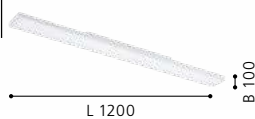

99843

LED



99843

LED

99843 TURCONA-B

ceiling light; aluminium, steel, white / plastic, white
Deckenleuchte; Alu, Stahl, weiss / Kunststoff, weiss
plafonnier; aluminium, acier, blanc / plastique, blanc

L 287, B 287, H 62

LED

12W

warm
WHITE

1000lm



TURCONA-B

These luminaires have a backlight technology.

Diese Leuchten verfügen über eine Backlight Technology.

Ces luminaires sont équipés d'une technologie de retour.



99844



99845



99846



99844 TURCONA-B

ceiling light; aluminium, steel, white / plastic, white
Deckenleuchte; Alu, Stahl, weiss / Kunststoff, weiss
plafonnier; aluminium, acier, blanc / plastique, blanc

L 437, B 437, H 70



24W 2400lm



9 002759 998448



99845 TURCONA-B

ceiling light; aluminium, steel, white / plastic, white
Deckenleuchte; Alu, Stahl, weiss / Kunststoff, weiss
plafonnier; aluminium, acier, blanc / plastique, blanc

L 587, B 587, H 70



36W 4100lm



9 002759 998455



99846 TURCONA-B

ceiling light; aluminium, steel, white / plastic, white
Deckenleuchte; Alu, Stahl, weiss / Kunststoff, weiss
plafonnier; aluminium, acier, blanc / plastique, blanc

L 1187, B 287, H 70



36W 4100lm



9 002759 998462

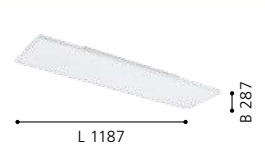

TURCONA - CCT

These luminaires have a backlight technology.

Diese Leuchten verfügen über eine Backlight Technology.

Ces luminaires sont équipés d'une technologie de retour.



99833



99833



99833 TURCONA-CCT

ceiling light; aluminium, steel, white / plastic, white
Deckenleuchte; Alu, Stahl, weiss / Kunststoff, weiss
plafonnier; aluminium, acier, blanc / plastique, blanc

L 287, B 287, H 62



12W

1200lm

remote





99834



99835



99836



99834 TURCONA-CCT

ceiling light; aluminium, steel, white / plastic, white
Deckenleuchte; Alu, Stahl, weiss / Kunststoff, weiss
plafonnier; aluminium, acier, blanc / plastique, blanc

L 437, B 437, H 70



99835 TURCONA-CCT

ceiling light; aluminium, steel, white / plastic, white
Deckenleuchte; Alu, Stahl, weiss / Kunststoff, weiss
plafonnier; aluminium, acier, blanc / plastique, blanc

L 587, B 587, H 70



99836 TURCONA-CCT

ceiling light; aluminium, steel, white / plastic, white
Deckenleuchte; Alu, Stahl, weiss / Kunststoff, weiss
plafonnier; aluminium, acier, blanc / plastique, blanc

L 1187, B 287, H 70



9 002759 998349



9 002759 998356

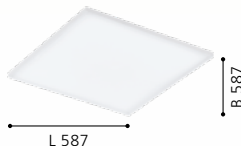

9 002759 998363





LED PANEL LUMINAIRES

WITH SUSPENSION FRAME

ADVANTAGES

- > SURFACE LIGHT WITH SHADOWLESS LIGHTING
 - > ULTRA-FLAT DESIGN
 - > HOMOGENEOUS SURFACE LIGHTING
 - > SIMPLE INSTALLATION
 - > ELEGANT SUSPENSION FRAME INCLUDED
 - > ALSO FOR FLUSH MOUNTING SUITABLE
-

VORTEILE

- > FLÄCHIGES LICHT MIT SCHATTENFREIER AUSLEUCHTUNG
 - > ULTRAFLACHES DESIGN
 - > HOMOGENE FLÄCHENAUSLEUCHTUNG
 - > EINFACHE MONTAGE
 - > INKL. ELEGANTEM SCHWEBERAHMEN
 - > AUCH FÜR FLÄCHENBÜNDIGEN EINBAU GEEIGNET
-

AVANTAGES

- > ÉCLAIRAGE ÉTALÉ AVEC ÉCLAIREMENT
- > SANS OMBRE
- > DESIGN ULTRA PLAT
- > ÉCLAIRAGE DE SURFACE HOMOGENÈ
- > MONTAGE SIMPLE
- > BÂTI FLOTTANT ÉLÉGANT INCLUS ADAPTÉ AU MONTAGE ENCASTRÉ

OVERVIEW

5 year warranty
Jahre Garantie
ans de garantie
anni di garanzia
años de garantía
anos de garantia



SALOBRENA 1
p.88



SALOBRENA 1
p.88



SALOBRENA 1
p.89



SALOBRENA 1
p.89



SALOBRENA 1
p.89



SALOBRENA-M
p.90



SALOBRENA-M
p.90



32812
white



32813, 98418
white



98129
white



32811, 98419
white

ACCESSORIES INCLUDED

Suspension frame for luminaires
Schweberahmen für Leuchten
Bâti flottant pour luminaires



MOUNTING MATERIAL NOT INCLUDED

Montagezubehör nicht inkludiert
Matériel de montage non inclus



32812



32812



98129



32812 SALOBRENA 1

ceiling light; aluminium, steel, white / plastic, white
 Deckenleuchte; Alu, Stahl, weiss / Kunststoff, weiss
 plafonnier; aluminium, acier, blanc / plastique, blanc

L 300, B 300, H 50



16W



2100lm



98129 SALOBRENA 1

ceiling light; aluminium, white / plastic, white
 Deckenleuchte; Alu, weiss / Kunststoff, weiss
 plafonnier; aluminium, blanc / plastique, blanc

L 450, B 450, H 50



21W



2700lm



9 002759 328122



9 002759 981297





32813



32811



98025



32813 SALOBRENA 1

ceiling light; aluminium, steel, white / plastic, white
Deckenleuchte; Alu, Stahl, weiss / Kunststoff, weiss
plafonnier; aluminium, acier, blanc / plastique, blanc

L 595, B 595, H 50



40W 4300lm

32811 SALOBRENA 1

ceiling light; aluminium, steel, white / plastic, white
Deckenleuchte; Alu, Stahl, weiss / Kunststoff, weiss
plafonnier; aluminium, acier, blanc / plastique, blanc

L 1200, B 300, H 50



40W 5500lm

98025 SALOBRENA 1

ceiling light; aluminium, white / plastic, white
Deckenleuchte; Alu, weiss / Kunststoff, weiss
plafonnier; aluminium, blanc / plastique, blanc

L 1195, B 100, H 45



36W 4700lm



9 002759 328139



9 002759 328115



9 002759 980252





98419



12 m
5 sec. - 15 min.



98418



12 m
5 sec. - 15 min.

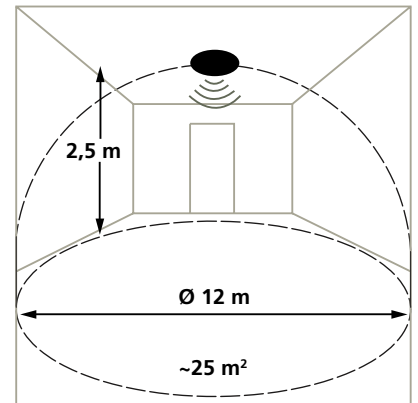

time: 5 sec. - 15 min.

98418 SALOBRENA-M

ceiling light; aluminium, white / plastic, white
Deckenleuchte; Alu, weiss / Kunststoff, weiss
plafonnier; aluminium, blanc / plastique, blanc

L 595, B 595, H 50



34W 4600lm



9 002759 984182



98419 SALOBRENA-M

ceiling light; aluminium, white / plastic, white
Deckenleuchte; Alu, weiss / Kunststoff, weiss
plafonnier; aluminium, blanc / plastique, blanc

L 1195, B 295, H 50



33W 5400lm



9 002759 984199



SALOBRENA-M

These luminaires come with an integrated motion sensor. This sensor is mounted invisibly.

Diese Leuchten sind mit einem integrierten Bewegungssensor ausgestattet. Der Sensor ist unsichtbar versteckt.

Ces luminaires viennent avec un capteur de mouvement intégré. Ce capteur est attaché invisiblement.

98419



12 m
5 sec. - 15 min.



3



2

1



LED PANEL LUMINAIRES

DIMMABLE

ADVANTAGES

- > DIMMABLE
 - > UNIFORM DISTRIBUTION OF LIGHT - IDEAL FOR ILLUMINATING SPACES AND SURFACES
 - > LOW TEMPERATURE ENHANCES SAFETY
 - > UP TO 80% POWER SAVINGS COMPARED TO INCANDESCENT LAMPS. SAVES YOUR BUDGET AND TAKES CARE OF THE ENVIRONMENT
 - > ELEGANT SUSPENSION FRAME INCLUDED
-

VORTEILE

- > DIMMBAR
 - > HOMOGENE LICHTVERTEILUNG - IDEAL ZUR BELEUCHTUNG VON RÄUMEN UND FLÄCHEN
 - > GERINGE WÄRMEENTWICKLUNG SORGT FÜR MEHR SICHERHEIT
 - > BIS ZU 80% STROMERSPARNIS GEGENÜBER GLÜHLAMPEN, SCHONT IHR BUDGET UND DIE UMWELT
 - > INKL. ELEGANTEM SCHWEBERAHMEN
-

AVANTAGES

- > GRADUABLE
- > DISTRIBUTION UNIFORME DE LA LUMIÈRE - IDÉAL POUR L'ILLUMINATION DES ESPACES ET SURFACES
- > FAIBLE CHALEUR AMÉLIORE LA SÉCURITÉ
- > JUSQU'À 80% D'ÉCONOMIES D'ÉNERGIE PAR RAPPORT AUX LAMPES À INCANDESCENCE, RÉDUIT VOTRE BUDGET ET PROTÈGE L'ENVIRONNEMENT
- > BÂTI FLOTTANT ÉLÉGANT INCLUS

OVERVIEW

5 year warranty
Jahre Garantie
ans de garantie
anni di garanzia
años de garantía
anos de garantía



SARSINA
p. 94



SARSINA
p. 94



SARSINA
p. 94



SARSINA
p. 95



SALOBRENA-
RGBW •
p. 96



SALOBRENA-
RGBW •
p. 96



97501 white



97502 white



97503 white



98485 white

ACCESSORIES INCLUDED

Suspension frame for luminaires
Schweberahmen für Leuchten
Bâti flottant pour luminaires



MOUNTING MATERIAL INCLUDED •

Montagezubehör inkludiert
Matériel de montage inclus



97501

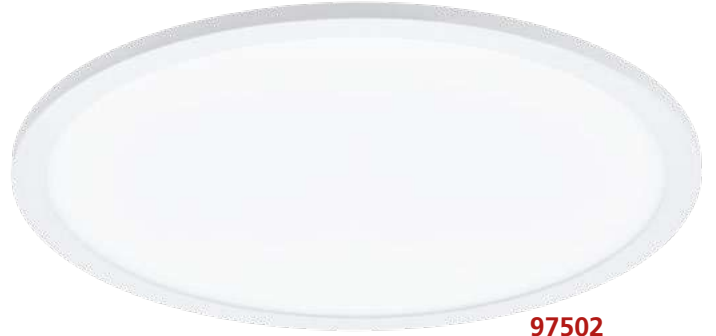

97502

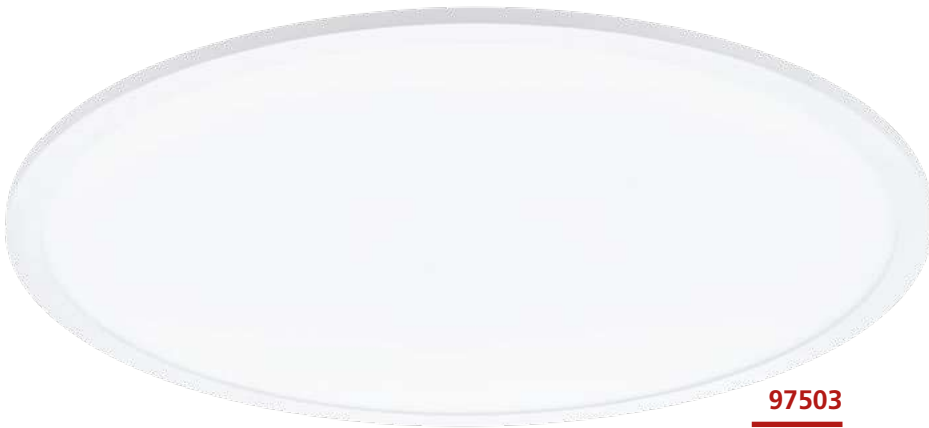

97503



97501 SARSINA

ceiling light; aluminium, white / plastic, white
Deckenleuchte; Alu, weiss / Kunststoff, weiss
plafonnier; aluminium, blanc / plastique, blanc

H 50, Ø 300



17W 2200lm

97502 SARSINA

ceiling light; aluminium, white / plastic, white
Deckenleuchte; Alu, weiss / Kunststoff, weiss
plafonnier; aluminium, blanc / plastique, blanc

H 50, Ø 450



28W 4200lm

97503 SARSINA

ceiling light; aluminium, white / plastic, white
Deckenleuchte; Alu, weiss / Kunststoff, weiss
plafonnier; aluminium, blanc / plastique, blanc

H 50, Ø 600



36W 5500lm



9 002759 975012



9 002759 975029



9 002759 975036

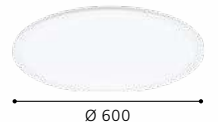



98485



98485



98485 SARSINA

ceiling light; aluminium, white / plastic, white
Deckenleuchte; Alu, weiss / Kunststoff, weiss
plafonnier; aluminium, blanc / plastique, blanc

H 50, Ø 800

LED

35W

neutral
WHITE

5900lm



9 002759 984854



Ø 800



33107



33108



33107 SALOBRENA-RGBW

grid light; aluminium, white / plastic, white
 Rasterleuchte; Alu, weiss / Kunststoff, weiss
 luminaire à grille; aluminium, blanc / plastique, blanc

L 450, B 450, H 11



33108 SALOBRENA-RGBW

grid light; aluminium, white / plastic, white
 Rasterleuchte; Alu, weiss / Kunststoff, weiss
 luminaire à grille; aluminium, blanc / plastique, blanc

L 600, B 300, H 11



SALOBRENA-RGBW

With the remote control (included in delivery) the following features can be adjusted:

Durch die Fernbedienung (im Lieferumfang enthalten) verfügen diese Leuchten über folgende Funktionen:

Les fonctions différentes peuvent être réglées avec une télécommande incluse avec le luminaire:

- > Color change
- > Change to white light
- > Change to RGB
- > Flash (fast color change)
- > Smooth dimming (slow color change)
 10%, 25%, 50%, 100%
- > on/off



9 002759 331078



9 002759 331085





33107

LED





LED PANEL LUMINAIRES

WOOD FRAME

ADVANTAGES

- > DECORATIVE ELEMENT FOR THE LIVING AREA
 - > EASY ASSEMBLY
 - > EASY TO CHANGE
 - > IN 3 WOOD COLORS
 - > WOOD AS A RENEWABLE RAW MATERIAL
-

VORTEILE





















- > DEKORATIVES ELEMENT FÜR DEN WOHNBEREICH
 - > EINFACHE MONTAGE
 - > EINFACH WECHSELBAR
 - > IN 3 HOLZFARBEN
 - > HOLZ ALS NACHWACHSENDER ROHS TÖFF
-

AVANTAGES

- > ÉLÉMENT DÉCORATIF POUR LE SALON
- > MONTAGE FACILE
- > FACILE À CHANGER
- > EN 3 COULEURS DE BOIS
- > LE BOIS COMME MATIÈRE PREMIÈRE RENOUVELABLE

OVERVIEW

5 year warranty
Jahre Garantie
ans de garantie
anni di garanzia
años de garantía
anos de garantía

 SALOBRENA-F p. 100	 SALOBRENA-F p. 100	 SALOBRENA-F p. 101	 SALOBRENA-F p. 101	 SALOBRENA-F p. 102	 SALOBRENA-F p. 102	 SALOBRENA-F p. 103	 SALOBRENA-F p. 103
 SALOBRENA-F p. 104	 SALOBRENA-F p. 104	 SALOBRENA-F p. 105	 SALOBRENA-F p. 105	 PIGLIONASSO p. 106	 PIGLIONASSO p. 106	 PIGLIONASSO p. 106	 PIGLIONASSO p. 107
 PIGLIONASSO p. 107	 PIGLIONASSO p. 107	 PIGLIONASSO p. 108	 PIGLIONASSO p. 108	 PIGLIONASSO p. 108			

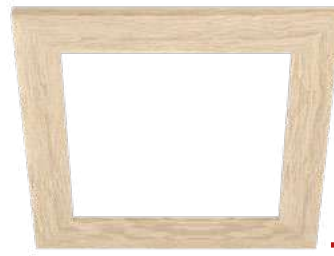

99421



99422

99421 SALOBRENA-F

accessory; wood, brown
Zubehör; Holz, braun
accessoire; bois, marron

L 340, B 340, H 16

99422 SALOBRENA-F

accessory; wood, brown
Zubehör; Holz, braun
accessoire; bois, marron

L 495, B 495, H 18



9 002759 994211

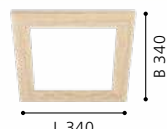

L 340

B 340



9 002759 994228

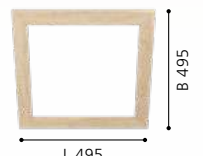

L 495

B 495

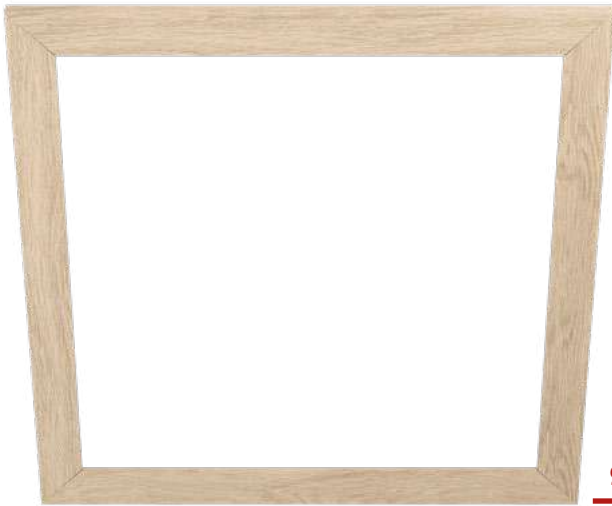

99423

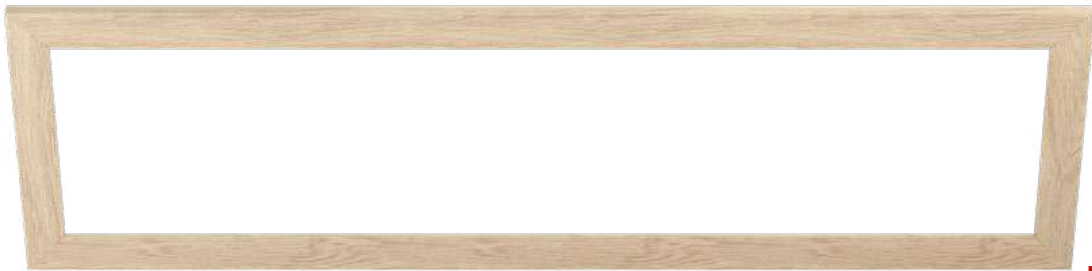

99424

99423 SALOBRENA-F

accessory; wood, brown
Zubehör; Holz, braun
accessoire; bois, marron

L 640, B 640, H 18

99424 SALOBRENA-F

accessory; wood, brown
Zubehör; Holz, braun
accessoire; bois, marron

L 1240, B 340, H 18



9 002759 994235



9 002759 994242

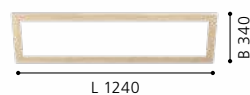



99425



99426

99425 SALOBRENA-F

accessory; wood, dark brown
Zubehör; Holz, dunkelbraun
accessoire; bois, marron foncé

L 340, B 340, H 16



9 002759 994259



L 340

99426 SALOBRENA-F

accessory; wood, dark brown
Zubehör; Holz, dunkelbraun
accessoire; bois, marron foncé

L 495, B 495, H 18



9 002759 994266



L 495

B 495



99427 SALOBRENA-F

accessory; wood, dark brown
Zubehör; Holz, dunkelbraun
accessoire; bois, marron foncé

L 640, B 640, H 18

99428 SALOBRENA-F

accessory; wood, dark brown
Zubehör; Holz, dunkelbraun
accessoire; bois, marron foncé

L 1240, B 340, H 18

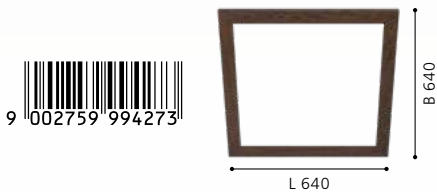



99431



99432

99431 SALOBRENA-F

accessory; wood, rustic
Zubehör; Holz, rustikal
accessoire; bois, rustique

L 340, B 340, H 16

99432 SALOBRENA-F

accessory; wood, rustic
Zubehör; Holz, rustikal
accessoire; bois, rustique

L 495, B 495, H 18



9 002759 994310



L 340



9 002759 994327



L 495

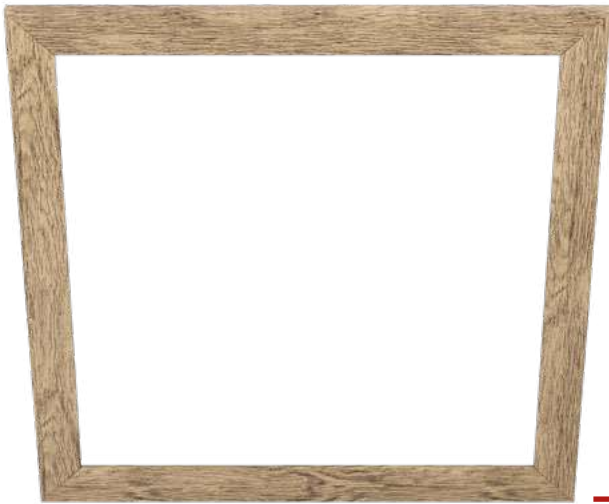

99433



99434

99433 SALOBRENA-F

accessory; wood, rustic
Zubehör; Holz, rustikal
accessoire; bois, rustique

L 640, B 640, H 18

99434 SALOBRENA-F

accessory; wood, rustic
Zubehör; Holz, rustikal
accessoire; bois, rustique

L 1240, B 340, H 18



9 002759 994334

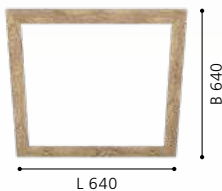

L 640

B 640



9 002759 994341



L 1240

B 340



99435



99436



99437



99435 PIGLIONASSO

ceiling light; steel, plastic, white / wood, rustikal
Deckenleuchte; Stahl, Kunststoff, weiss / Holz, rustikal
plafonnier; acier, plastique, blanc / bois, rustikal

L 500, B 500, H 55



20W 2850lm



9 002759 994358

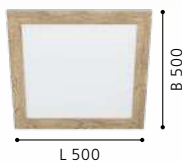

99436 PIGLIONASSO

ceiling light; steel, plastic, white / wood, rustikal
Deckenleuchte; Stahl, Kunststoff, weiss / Holz, rustikal
plafonnier; acier, plastique, blanc / bois, rustikal

L 645, B 645, H 55



32W 4700lm



9 002759 994365

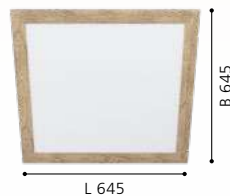

99437 PIGLIONASSO

ceiling light; steel, plastic, white / wood, rustikal
Deckenleuchte; Stahl, Kunststoff, weiss / Holz, rustikal
plafonnier; acier, plastique, blanc / bois, rustikal

L 1245, B 345, H 55



32W 4700lm



9 002759 994372



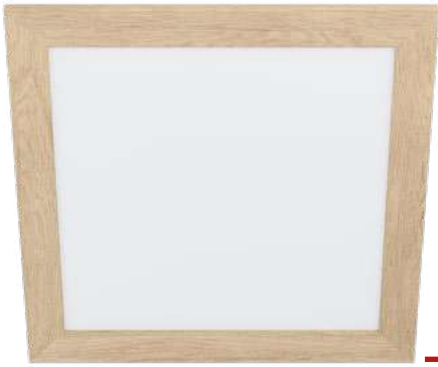

99471

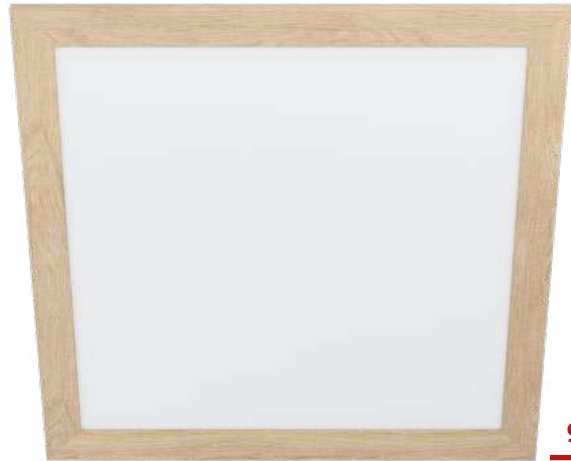

99472



99473



99471 PIGLIONASSO

ceiling light; steel, plastic, white / wood, brown
Deckenleuchte; Stahl, Kunststoff, weiss / Holz, braun
plafonnier; acier, plastique, blanc / bois, marron

L 500, B 500, H 55



20W 2850lm

99472 PIGLIONASSO

ceiling light; steel, plastic, white / wood, brown
Deckenleuchte; Stahl, Kunststoff, weiss / Holz, braun
plafonnier; acier, plastique, blanc / bois, marron

L 645, B 645, H 55



32W 4700lm

99473 PIGLIONASSO

ceiling light; steel, plastic, white / wood, brown
Deckenleuchte; Stahl, Kunststoff, weiss / Holz, braun
plafonnier; acier, plastique, blanc / bois, marron

L 1245, B 345, H 55



32W 4700lm



9 002759 994716

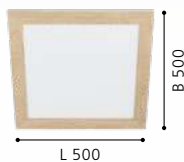

9 002759 994723

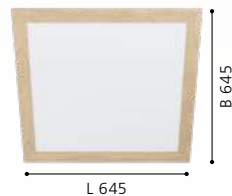

9 002759 994730





99474



99475



99476



99474 PIGLIONASSO

ceiling light; steel, plastic, white / wood, dark brown
Deckenleuchte; Stahl, Kunststoff, weiss / Holz, dunkelbraun
plafonnier; acier, plastique, blanc / bois, marron foncé

L 500, B 500, H 55



20W 2850lm



9 002759 994747

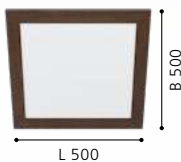

99475 PIGLIONASSO

ceiling light; steel, plastic, white / wood, dark brown
Deckenleuchte; Stahl, Kunststoff, weiss / Holz, dunkelbraun
plafonnier; acier, plastique, blanc / bois, marron foncé

L 645, B 645, H 55



32W 4700lm



9 002759 994754



99476 PIGLIONASSO

ceiling light; steel, plastic, white / wood, dark brown
Deckenleuchte; Stahl, Kunststoff, weiss / Holz, dunkelbraun
plafonnier; acier, plastique, blanc / bois, marron foncé

L 1245, B 345, H 55



32W 4700lm



9 002759 994761





99475

LED





RECESSED LUMINAIRES

HIGH VOLTAGE

ADVANTAGES

- > LOW MOUNTING DEPTH
- > NO TRANSFORMER NECESSARY - THE LATEST LED HIGH-VOLTAGE TECHNOLOGY
- > IDEAL FOR LIGHTING OF ROOMS AND AREAS
- > PLEASANT WARM WHITE LIGHT COLOR
- > LOW TEMPERATURE ENHANCES SAFETY
- > UP TO 80% POWER SAVINGS COMPARED TO INCANDESCENT LAMPS, EASY ON YOUR BUDGET AND THE ENVIRONMENT
- > EASY AND SIMPLE WIRING BY 2-FOLD JUNCTION BOX - EASILY EXPANDABLE

VORTEILE















































- > GERINGE EINBAUTIEFE
- > KEIN TRAFU MEHR NOTWENDIG - NEUESTE LED HOCHVOLT TECHNOLOGIE
- > IDEAL ZUR BELEUCHTUNG VON RÄUMEN UND FLÄCHEN
- > ANGENEHME WARM-WEISSE LICHTFARBE
- > GERINGE WÄRMEENTWICKLUNG SORGT FÜR MEHR SICHERHEIT
- > BIS ZU 80% STROMERSPARNIS GEGENÜBER GLÜHLAMPEN, SCHONT IHR BUDGET UND DIE UMWELT
- > EINFACHE UND SICHERE VERKABELUNG DURCH 2-FACH ANSCHLUSSBOX - UNKOMPLIZIERT ERWEITERBAR

ADVANTAGES

- > FAIBLE PROFONDEUR DE MONTAGE
- > AUCUN TRANSFORMATEUR NÉCESSAIRE - LA DERNIÈRE TECHNOLOGIE À HAUTE TENSION LED
- > IDÉAL POUR L'ÉCLAIRAGE DES CHAMBRES ET DES ESPACES
- > AGRÉABLE COULEUR DE LUMIÈRE BLANCHE CHAUDE
- > FAIBLE CHALEUR AMÉLIORE LA SÉCURITÉ
- > JUSQU'À 80% D'ÉCONOMIES D'ÉNERGIE PAR RAPPORT AUX LAMPES À INCANDESCENCE, RÉDUIT VOTRE BUDGET ET PROTÈGE L'ENVIRONNEMENT
- > NOTRE BOITE DE DEUX JONCTIONS PERMET UN CÂBLAGE SIMPLE ET SECURE. EN PLUS ELLE EST FACILEMENT EXTENSIBLE.

OVERVIEW

5 year warranty
 Jahre Garantie
 ans de garantie
 anni di garanzia
 años de garantía
 años de garantía

							
PINEDA p. 114	PINEDA p. 115	PINEDA p. 115	PINEDA p. 115	PINEDA p. 116	PINEDA p. 116	PINEDA p. 116	PINEDA p. 117
							
PINEDA p. 117	PINEDA p. 117	PINEDA p. 118	PINEDA p. 118	PINEDA p. 118	SARTIANO p. 120	SALICETO p. 122	SALICETO p. 122
							
SALICETO p. 122	SALICETO p. 123	SALICETO p. 124	SALICETO p. 124	SALICETO p. 124	SALICETO p. 125	SALICETO p. 126	SALICETO p. 126
							
SALICETO p. 126	SALICETO p. 127	SALICETO p. 127	SALICETO p. 128	SALICETO p. 128	SALICETO p. 128	SALICETO p. 129	SALICETO p. 129
							
SALABATE p. 130	SALABATE p. 130	SALABATE p. 130	SALABATE p. 131	SALABATE p. 131	SALABATE p. 131	PINEDA p. 132	PINEDA p. 132
							
PINEDA p. 132	PINEDA p. 133	PINEDA p. 133	PINEDA p. 133	PINEDA p. 134	PINEDA p. 134	PINEDA p. 134	PINEDA 1 p. 135
							
PINEDA 1 p. 135	ZARATE p. 136	ZARATE p. 136	MECINOS p. 137	MECINOS p. 137			



1 SIMPLE INSTALLATION!

Einfache Montage! / Montage simple !

Universally usable in walls or ceilings thanks to its small installation depth!

Durch die geringe Einbautiefe universell einsetzbar, ob Wand oder Decke!

Emploi universel dû à la faible profondeur de montage, que ce soit au mur ou au plafond !

2 QUICK AND SAFE CONNECTION!

Schnelles und sicheres Anschließen! /
Branchement rapide et sûr !

Easy wiring with the practical connection box!
No transformer is needed anymore thanks to
state of-the-art high-voltage technology!

Leichtes Verkabeln durch die praktische An-
schlussbox! Durch moderne Hochvolt-Technik
wird kein Trafo mehr benötigt!

Câbler simplement avec le boîtier de
branchement pratique ! Grâce à la technique de
haute tension moderne, plus besoin de transfor-
mateur !



3 PERFECT FIT!

Perfekter Halt! / Maintien parfait !

The integrated holding brackets permit simple
installation and guarantee for a precise fit!

Die integrierten Halteklammern ermöglichen
einen einfachen Einbau und sorgen für garantierte
Passgenauigkeit!

Les griffes de maintien intégrées permettent un
montage simple et assurent un parfait ajustement !





4

FLUSH INSTALLATION!

FLÄCHENBÜNDIGER EINBAU! / MONTAGE À FLEUR !

The slim build permits fitting installation in any surface!

Die schlanke Bauform ermöglicht den passenden Einbau bei jeder Fläche!

La structure fine permet le montage adéquat avec chaque surface !





95848

LED



95848

LED

95848 PINEDA

recessed light; plastic, chrome
 Einbauleuchte; Kunststoff, chrom
 luminaire encastrable; plastique, chrome

Ø 84, ET 40

LED

1x 6W

warm
WHITE

1x
500lm



Ø 72



9 002759 958480





95854



95856



95855



95854 PINEDA

recessed light; plastic, white
 Einbauleuchte; Kunststoff, weiss
 luminaire encastrable; plastique, blanc

Ø 84, ET 40



1x 6W
 1x 500lm
 Ø 72



9 002759 958541



Ø 84

95855 PINEDA

recessed light; plastic, chrome
 Einbauleuchte; Kunststoff, chrom
 luminaire encastrable; plastique, chrome

Ø 84, ET 40



1x 6W
 1x 500lm
 Ø 72



9 002759 958558



Ø 84

95856 PINEDA

recessed light; plastic, satin nickel
 Einbauleuchte; Kunststoff, nickel-matt
 luminaire encastrable; plastique, nickel mat

Ø 84, ET 40



1x 6W
 1x 500lm
 Ø 72



9 002759 958565



Ø 84



95851

LED



95853

LED



95852

LED

95851 PINEDA

recessed light; plastic, white
 Einbauleuchte; Kunststoff, weiss
 luminaire encastrable; plastique, blanc

95852 PINEDA

recessed light; plastic, chrome
 Einbauleuchte; Kunststoff, chrom
 luminaire encastrable; plastique, chrome

95853 PINEDA

recessed light; plastic, satin nickel
 Einbauleuchte; Kunststoff, nickel-matt
 luminaire encastrable; plastique, nickel mat

Ø 84, ET 40



9 002759 958510



Ø 84

Ø 84, ET 40



9 002759 958527



Ø 84

Ø 84, ET 40



9 002759 958534



Ø 84



95857



95858



95859



95857 PINEDA

recessed light; plastic, white
 Einbauleuchte; Kunststoff, weiss
 luminaire encastrable; plastique, blanc

95858 PINEDA

recessed light; plastic, chrome
 Einbauleuchte; Kunststoff, chrom
 luminaire encastrable; plastique, chrome

95859 PINEDA

recessed light; plastic, satin nickel
 Einbauleuchte; Kunststoff, nickel-matt
 luminaire encastrable; plastique, nickel mat

Ø 84, ET 40



3x 6W

3x
500lm

Ø 72



9 002759 958572



Ø 84

Ø 84, ET 40



3x 6W

3x
500lm

Ø 72



9 002759 958589



Ø 84

Ø 84, ET 40



3x 6W

3x
500lm

Ø 72



9 002759 958596



Ø 84



95843

LED



95844

LED



95846

LED



95843 PINEDA

recessed light; plastic, satin nickel
Einbauleuchte; Kunststoff, nickel-matt
luminaire encastrable; plastique, nickel mat

95844 PINEDA

recessed light; plastic, white
Einbauleuchte; Kunststoff, weiss
luminaire encastrable; plastique, blanc

95846 PINEDA

recessed light; plastic, satin nickel
Einbauleuchte; Kunststoff, nickel-matt
luminaire encastrable; plastique, nickel mat

L 84, B 84, ET 40



1x 6W
1x 500lm



L 84, B 84, ET 40



3x 6W
3x 500lm



L 84, B 84, ET 40



3x 6W
3x 500lm



9 002759 958435



9 002759 958442



9 002759 958466





95844

LED



32896

LED

32896 SARTIANO

recessed light; plastic, white

Einbauleuchte; Kunststoff, weiss

luminaire encastrable; plastique, blanc

Ø 90, ET 45

LED

3x 5W

warm
WHITE

3x
470lm



Ø73



9 002759 328962





32896

LED



98243



98244



98607



98243 SALICETO

recessed light; aluminium, white
Einbauleuchte; Alu, weiss
luminaire encastrable; aluminium, blanc

H 42, Ø 88, ET 50



98244 SALICETO

recessed light; aluminium, satin nickel
Einbauleuchte; Alu, nickel-matt
luminaire encastrable; aluminium, nickel mat

H 42, Ø 88, ET 50



98607 SALICETO

recessed light; aluminium, black
Einbauleuchte; Alu, schwarz
luminaire encastrable; aluminium, noir

H 42, Ø 88, ET 50



9 002759 982430



Ø 88



9 002759 982447



Ø 88



9 002759 986070



Ø 88



98244



98246



98246 SALICETO

recessed light; aluminium, satin nickel

Einbauleuchte; Alu, nickel-matt

luminaire encastrable; aluminium, nickel mat

H 42, Ø 88, ET 50

LED

6W

neutral
WHITE

450lm



Ø68



9 002759 982461



Ø 88



98471



98473



98472



98471 SALICETO

recessed light; aluminium, white / glass, clear
 Einbauleuchte; Alu, weiss / Glas, klar
 luminaire encastrable; aluminium, blanc / verre, clair

98472 SALICETO

recessed light; aluminium, satin nickel / glass, clear
 Einbauleuchte; Alu, nickel-matt / Glas, klar
 luminaire encastrable; aluminium, nickel mat / verre, clair

98473 SALICETO

recessed light; aluminium, white / glass, clear
 Einbauleuchte; Alu, weiss / Glas, klar
 luminaire encastrable; aluminium, blanc / verre, clair

L 88, B 88, H 42, ET 50



L 88, B 88, H 42, ET 50



L 88, B 88, H 42, ET 50



9 002759 984717



9 002759 984724



9 002759 984731





98474

LED



98474

LED



98474 SALICETO

recessed light; aluminium, satin nickel / glass, clear
Einbauleuchte; Alu, nickel-matt / Glas, klar
luminaire encastrable; aluminium, nickel mat / verre, clair

L 88, B 88, H 42, ET 50

LED

6W

neutral
WHITE

450lm



Ø68



9 002759 984748





98301



98303



98609



98301 SALICETO

recessed light; aluminium, white
 Einbauleuchte; Alu, weiss
 luminaire encastrable; aluminium, blanc

H 42, Ø 88, ET 50



98303 SALICETO

recessed light; aluminium, satin nickel
 Einbauleuchte; Alu, nickel-matt
 luminaire encastrable; aluminium, nickel mat

H 42, Ø 88, ET 50



98609 SALICETO

recessed light; aluminium, black
 Einbauleuchte; Alu, schwarz
 luminaire encastrable; aluminium, noir

H 42, Ø 88, ET 50



9 002759 983017



Ø 88



9 002759 983031



Ø 88



9 002759 986094



Ø 88





98305

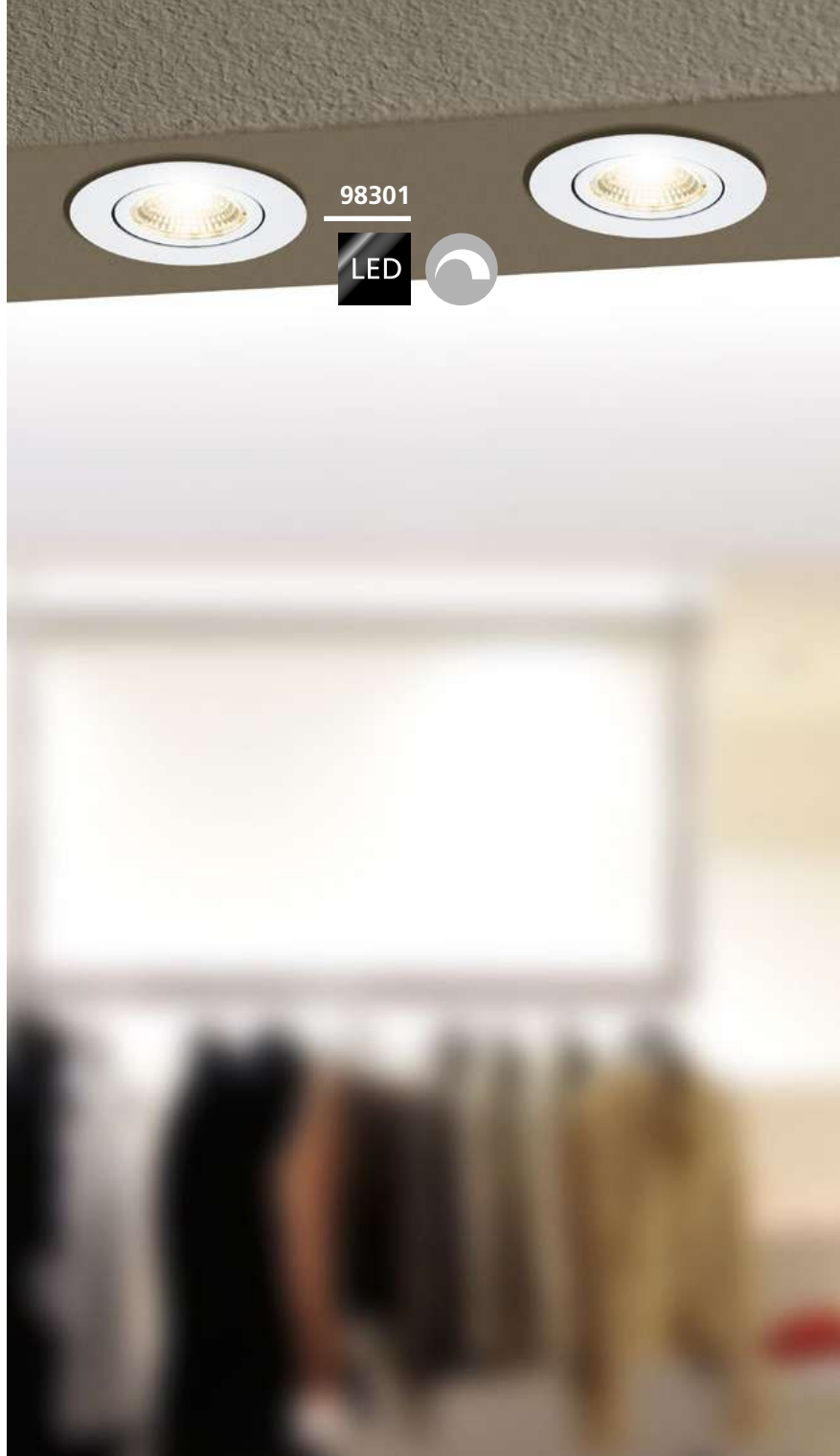

98301



98307



98305 SALICETO

recessed light; aluminium, white
 Einbauleuchte; Alu, weiss
 luminaire encastrable; aluminium, blanc

H 42, Ø 88, ET 50



98307 SALICETO

recessed light; aluminium, satin nickel
 Einbauleuchte; Alu, nickel-matt
 luminaire encastrable; aluminium, nickel mat

H 42, Ø 88, ET 50



9 002759 983055



Ø 88



9 002759 983079

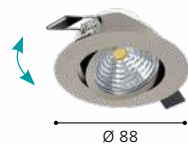

Ø 88





98302



98304



98611



98302 SALICETO

recessed light; aluminium, white
 Einbauleuchte; Alu, weiss
 luminaire encastrable; aluminium, blanc

L 88, B 88, H 42, ET 50



98304 SALICETO

recessed light; aluminium, satin nickel
 Einbauleuchte; Alu, nickel-matt
 luminaire encastrable; aluminium, nickel mat

L 88, B 88, H 42, ET 50



98611 SALICETO

recessed light; aluminium, black
 Einbauleuchte; Alu, schwarz
 luminaire encastrable; aluminium, noir

L 88, B 88, H 42, ET 50

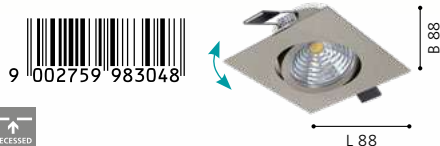



98306



98308



98308



98306 SALICETO

recessed light; aluminium, white
 Einbauleuchte; Alu, weiss
 luminaire encastrable; aluminium, blanc

L 88, B 88, H 42, ET 50



98308 SALICETO

recessed light; aluminium, satin nickel
 Einbauleuchte; Alu, nickel-matt
 luminaire encastrable; aluminium, nickel mat

L 88, B 88, H 42, ET 50



9 002759 983062



9 002759 983086





98238



IP20/44



99493



IP20/44



98241



IP20/44



98238 SALABATE

recessed light; aluminium, white / glass, clear
 Einbauleuchte; Alu, weiss / Glas, klar
 luminaire encastrable; aluminium, blanc / verre, clair

Ø 88, ET 52



98241 SALABATE

recessed light; aluminium, white / glass, clear
 Einbauleuchte; Alu, weiss / Glas, klar
 luminaire encastrable; aluminium, blanc / verre, clair

Ø 88, ET 52



99493 SALABATE

recessed light; aluminium, black / glass, clear
 Einbauleuchte; Alu, schwarz / Glas, klar
 luminaire encastrable; aluminium, noir / verre, clair

Ø 88, ET 52





99494



99494 SALABATE

recessed light; aluminium, black / glass, clear
 Einbauleuchte; Alu, schwarz / Glas, klar
 luminaire encastrable; aluminium, noir / verre, clair

Ø 88, ET 52



9 002759 994945



Ø 88



98239



98239 SALABATE

recessed light; aluminium, white / glass, clear
 Einbauleuchte; Alu, weiss / Glas, klar
 luminaire encastrable; aluminium, blanc / verre, clair

L 88, B 88, ET 52



9 002759 982393



L 88



B 88

98242 SALABATE

recessed light; aluminium, white / glass, clear
 Einbauleuchte; Alu, weiss / Glas, klar
 luminaire encastrable; aluminium, blanc / verre, clair

L 88, B 88, ET 52



9 002759 982423



L 88

B 88



95817



IP20/44



95819



IP20/44



95818



IP20/44

95817 PINEDA

recessed light; plastic, white
 Einbauleuchte; Kunststoff, weiss
 luminaire encastrable; plastique, blanc

95818 PINEDA

recessed light; plastic, chrome
 Einbauleuchte; Kunststoff, chrom
 luminaire encastrable; plastique, chrome

95819 PINEDA

recessed light; plastic, satin nickel
 Einbauleuchte; Kunststoff, nickel-matt
 luminaire encastrable; plastique, nickel mat

Ø 78, ET 35



9 002759 958176



Ø 78

Ø 78, ET 35



9 002759 958183



Ø 78

Ø 78, ET 35



9 002759 958190



Ø 78



95821

LED



IP20/44



95823

LED



IP20/44

95822

LED



IP20/44

95821 PINEDA

recessed light; plastic, white
 Einbauleuchte; Kunststoff, weiss
 luminaire encastrable; plastique, blanc

95822 PINEDA

recessed light; plastic, chrome
 Einbauleuchte; Kunststoff, chrom
 luminaire encastrable; plastique, chrome

95823 PINEDA

recessed light; plastic, satin nickel
 Einbauleuchte; Kunststoff, nickel-matt
 luminaire encastrable; plastique, nickel mat

Ø 78, ET 35

LED

3x 6W

warm
WHITE

3x
500lm



Ø 65



IP44/20



9 002759 958213



Ø 78

Ø 78, ET 35

LED

3x 6W

warm
WHITE

3x
500lm



Ø 65



IP44/20



9 002759 958220



Ø 78

Ø 78, ET 35

LED

3x 6W

warm
WHITE

3x
500lm



Ø 65



IP44/20



9 002759 958237



Ø 78

95962, 95887, 95888, 95889

These luminaires are protected against splash water.

Diese Leuchten sind gegen Spritzwasser geschützt.

Les luminaires sont protégées contre les éclaboussures d'eau.



95887



IP20/44



	0	1	2	3
EU	X	X	✓	✓
FR	X	X	X	✓



95888



IP20/44



95889



IP20/44

95887 PINEDA

recessed light; plastic, white
Einbauleuchte; Kunststoff, weiss
luminaire encastrable; plastique, blanc

95888 PINEDA

recessed light; plastic, chrome
Einbauleuchte; Kunststoff, chrom
luminaire encastrable; plastique, chrome

95889 PINEDA

recessed light; plastic, satin nickel
Einbauleuchte; Kunststoff, nickel-matt
luminaire encastrable; plastique, nickel mat

Ø 102, ET 35



9 002759 958879



Ø 102

Ø 102, ET 35



9 002759 958886



Ø 102

Ø 102, ET 35



9 002759 958893



Ø 102



95932

LED



95962

LED



IP44



95932

LED

95932 PINEDA 1

recessed light; steel, plastic, white, satin nickel / plastic, clear, satined

Einbauleuchte; Stahl, Kunststoff, weiss, nickel-matt / Kunststoff, klar, satiniert

luminaire encastrable; acier, plastique, blanc, nickel mat / plastique, clair, satiné
Ø 145, ET 35

LED

1x 12W

warm
WHITE

1x
1000lm



Ø 90



9 002759 959326



Ø 145



95962 PINEDA 1

recessed light; steel, plastic, chrome / plastic, white

Einbauleuchte; Stahl, Kunststoff, chrom / Kunststoff, weiss

luminaire encastrable; acier, plastique, chrome / plastique, blanc

Ø 82, ET 35

LED

1x 6W

warm
WHITE

1x
500lm



Ø 65



IP44



9 002759 959623



Ø 82





96901



96902

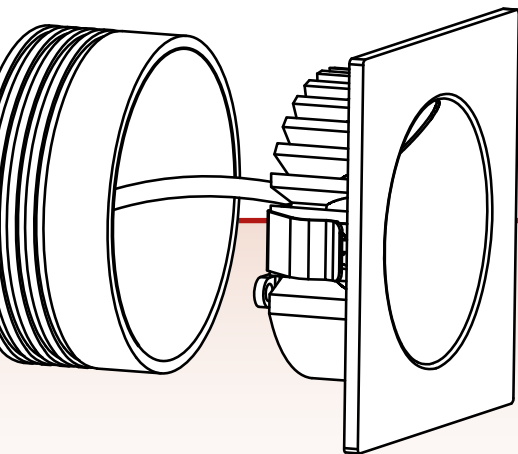

96901 ZARATE

recessed light; cast aluminium, white / plastic, white
 Einbauleuchte; Aluguss, weiss / Kunststoff, weiss
 luminaire encastrable; fonte d'aluminium, blanc / plastique, blanc

L 80, H 80, ET 40



96902 ZARATE

recessed light; cast aluminium, silver / plastic, white
 Einbauleuchte; Aluguss, silber / Kunststoff, weiss
 luminaire encastrable; fonte d'aluminium, argent / plastique, blanc

L 80, H 80, ET 40



96901 & 96902

including plaster ring

inklusive Einputzring

y compris l'anneau de plâtre



9 002759 969011



L 80

H 80



9 002759 969028



L 80

H 80



99643

LED



99644

LED



99644

LED

99643 MECINOS

recessed light; steel, white
 Einbauleuchte; Stahl, weiss
 luminaire encastrable; acier, blanc

L 80, B 80, H 3

LED

1x 2W

warm
 WHITE

200lm



Ø65



9 002759 996437



99644 MECINOS

recessed light; steel, black
 Einbauleuchte; Stahl, schwarz
 luminaire encastrable; acier, noir

L 80, B 80, H 3

LED

1x 2W

warm
 WHITE

200lm



Ø65



9 002759 996444



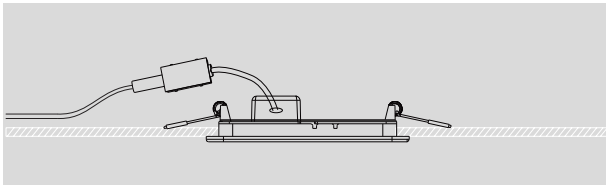

RECESSED LUMINAIRES

FUEVA 5

ADVANTAGES

- > MODERN APPEARANCE - THE NEW FUEVA CONVINCES WITH ITS FLAT DESIGN AND NARROW FRAME.
- > THE FUEVA 5 IS AVAILABLE IN THE TREND COLOUR BLACK.
- > INCLUSIVE PLUG-IN TERMINAL - FOR QUICK WORK AND EASY HANDLING

VORTEILE







































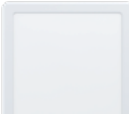





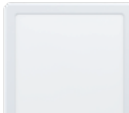

















- > MODERNES ERSCHEINUNGSBILD - DIE NEUE FUEVA ÜBERZEUGT DURCH IHR FLACHES DESIGN SOWIE DEN SCHMALEN RAHMEN.
- > DIE FUEVA 5 IST IN DER TRENDFARBE SCHWARZ ERHÄLTlich.
- > INKLUSIVE STECKKLEMME - FÜR DAS SCHNELLE ARBEITEN UND EINE EINFACHE HANDHABUNG

ADVANTAGES

- > APPARENCE MODERNE - LE NOUVEAU FUEVA CONVAINC PAR SON DESIGN PLAT ET SON CADRE ÉTROIT.
- > LE FUEVA 5 EST DISPONIBLE DANS LA COULEUR TENDANCE NOIRE.
- > Y COMPRIS UNE BORNE ENFICHABLE - POUR UN TRAVAIL RAPIDE ET UNE MANIPULATION SIMPLE

OVERVIEW

5 year warranty
 Jahre Garantie
 ans de garantie
 anni di garanzia
 años de garantía

							
FUEVA 5 p. 140	FUEVA 5 p. 140	FUEVA 5 p. 140	FUEVA 5 p. 141	FUEVA 5 p. 141	FUEVA 5 p. 142	FUEVA 5 p. 142	FUEVA 5 p. 142
							
FUEVA 5 p. 143	FUEVA 5 p. 143	FUEVA 5 p. 144	FUEVA 5 p. 144	FUEVA 5 p. 144	FUEVA 5 p. 145	FUEVA 5 p. 145	FUEVA 5 p. 146
							
FUEVA 5 p. 146	FUEVA 5 p. 146	FUEVA 5 p. 147	FUEVA 5 p. 148	FUEVA 5 p. 148	FUEVA 5 p. 148	FUEVA 5 p. 149	FUEVA 5 p. 150
							
FUEVA 5 p. 150	FUEVA 5 p. 150	FUEVA 5 p. 151	FUEVA 5 p. 152	FUEVA 5 p. 152	FUEVA 5 p. 152	FUEVA 5 p. 153	FUEVA 5 p. 153
							
FUEVA 5 p. 153	FUEVA 5 p. 154	FUEVA 5 p. 154	FUEVA 5 p. 154	FUEVA 5 p. 155	FUEVA 5 p. 155	FUEVA 5 p. 155	FUEVA 5 p. 157
							
FUEVA 5 p. 157	FUEVA 5 p. 157	FUEVA 5 p. 159	FUEVA 5 p. 159	FUEVA 5 p. 159	FUEVA 5 p. 160	FUEVA 5 p. 160	FUEVA 5 p. 160
							
FUEVA 5 p. 161	FUEVA 5 p. 162	FUEVA 5 p. 162	FUEVA 5 p. 162	FUEVA 5 p. 163	FUEVA 5 p. 164	FUEVA 5 p. 164	FUEVA 5 p. 164
							
FUEVA 5 p. 165	FUEVA FLEX p. 166	FUEVA FLEX p. 166	FUEVA FLEX p. 166	FUEVA FLEX p. 167	FUEVA FLEX p. 167	FUEVA FLEX p. 167	



99131



99133



99132



99131 FUEVA 5

recessed light; steel, white / plastic, white
Einbauleuchte; Stahl, weiss / Kunststoff, weiss
luminaire encastrable; acier, blanc / plastique, blanc

Ø 86, ET 26



2,7W 300lm

Ø 75



9 002759 991319



Ø 86

Ø 117, ET 26



5,5W 650lm

Ø 105



9 002759 991326



Ø 117

99133 FUEVA 5

recessed light; steel, white / plastic, white
Einbauleuchte; Stahl, weiss / Kunststoff, weiss
luminaire encastrable; acier, blanc / plastique, blanc

Ø 166, ET 26



10,5W 1200lm

Ø 155



9 002759 991333



Ø 166



99134



99135



99134 FUEVA 5

recessed light; steel, white / plastic, white
Einbauleuchte; Stahl, weiss / Kunststoff, weiss
luminaire encastrable; acier, blanc / plastique, blanc

Ø 216, ET 26



16,5 W



1800lm



Ø 205



99135 FUEVA 5

recessed light; steel, white / plastic, white
Einbauleuchte; Stahl, weiss / Kunststoff, weiss
luminaire encastrable; acier, blanc / plastique, blanc

Ø 86, ET 26



3x 2,7 W



3x
300lm



Ø 75



9 002759 991340



Ø 216



9 002759 991357



Ø 86





99136



99138



99137



99136 FUEVA 5

recessed light; steel, satin nickel / plastic, white
Einbauleuchte; Stahl, nickel-matt / Kunststoff, weiss
luminaire encastrable; acier, nickel mat / plastique, blanc

Ø 86, ET 26



2,7W 300lm

Ø 75



9 002759 991364



Ø 86

99137 FUEVA 5

recessed light; steel, satin nickel / plastic, white
Einbauleuchte; Stahl, nickel-matt / Kunststoff, weiss
luminaire encastrable; acier, nickel mat / plastique, blanc

Ø 117, ET 26



5,5W 650lm

Ø 105



9 002759 991374



Ø 117

99138 FUEVA 5

recessed light; steel, satin nickel / plastic, white
Einbauleuchte; Stahl, nickel-matt / Kunststoff, weiss
luminaire encastrable; acier, nickel mat / plastique, blanc

Ø 166, ET 26



10,5W 1200lm

Ø 155



9 002759 991388



Ø 166



99139



99141



99139 FUEVA 5

recessed light; steel, satin nickel / plastic, white
 Einbauleuchte; Stahl, nickel-matt / Kunststoff, weiss
 luminaire encastrable; acier, nickel mat / plastique, blanc

Ø 216, ET 26



16,5 W 1800 lm



Ø 216

99141 FUEVA 5

recessed light; steel, satin nickel / plastic, white
 Einbauleuchte; Stahl, nickel-matt / Kunststoff, weiss
 luminaire encastrable; acier, nickel mat / plastique, blanc

Ø 86, ET 26



3x 2,7 W 3x 300 lm



Ø 86



9 002759 991395



9 002759 991418





99142

LED



99144

LED



99143

LED

99142 FUEVA 5

recessed light; steel, black / plastic, white
Einbauleuchte; Stahl, schwarz / Kunststoff, weiss
luminaire encastrable; acier, noir / plastique, blanc

Ø 86, ET 26



2,7W 300lm

Ø 75



9 002759 991425



Ø 86

99143 FUEVA 5

recessed light; steel, black / plastic, white
Einbauleuchte; Stahl, schwarz / Kunststoff, weiss
luminaire encastrable; acier, noir / plastique, blanc

Ø 117, ET 26



5,5W 650lm

Ø 105



9 002759 991432



Ø 117

99144 FUEVA 5

recessed light; steel, black / plastic, white
Einbauleuchte; Stahl, schwarz / Kunststoff, weiss
luminaire encastrable; acier, noir / plastique, blanc

Ø 166, ET 26



10,5W 1200lm

Ø 155



9 002759 991449



Ø 166



99145

LED



99146

LED

99145 FUEVA 5

recessed light; steel, black / plastic, white
Einbauleuchte; Stahl, schwarz / Kunststoff, weiss
luminaire encastrable; acier, noir / plastique, blanc

Ø 216, ET 26

LED

16,5 W

warm
WHITE

1800 lm



Ø 205



9 002759 991456



Ø 216



99146 FUEVA 5

recessed light; steel, black / plastic, white
Einbauleuchte; Stahl, schwarz / Kunststoff, weiss
luminaire encastrable; acier, noir / plastique, blanc

Ø 86, ET 26

LED

3x 2,7 W

warm
WHITE

3x
300 lm



Ø 75



9 002759 991463



Ø 86





99147

LED



99149

LED



99148

LED

99147 FUEVA 5

recessed light; steel, white / plastic, white
Einbauleuchte; Stahl, weiss / Kunststoff, weiss
luminaire encastrable; acier, blanc / plastique, blanc

Ø 86, ET 26



2,7W 360lm

Ø 75



9 002759 991470



Ø 86

99148 FUEVA 5

recessed light; steel, white / plastic, white
Einbauleuchte; Stahl, weiss / Kunststoff, weiss
luminaire encastrable; acier, blanc / plastique, blanc

Ø 117, ET 26



5,5W 700lm

Ø 105



9 002759 991487



Ø 117

99149 FUEVA 5

recessed light; steel, white / plastic, white
Einbauleuchte; Stahl, weiss / Kunststoff, weiss
luminaire encastrable; acier, blanc / plastique, blanc

Ø 166, ET 26



10,5W 1350lm

Ø 155



9 002759 991494



Ø 166



99151

LED



99151

LED

99151 FUEVA 5

recessed light; steel, white / plastic, white
Einbauleuchte; Stahl, weiss / Kunststoff, weiss
luminaire encastrable; acier, blanc / plastique, blanc

Ø 216, ET 26

LED

16,5 W

neutral
WHITE

2000lm



Ø205



9 002759 991517



Ø 216



99152

LED



99154

LED



99153

LED

99152 FUEVA 5

recessed light; steel, satin nickel / plastic, white
Einbauleuchte; Stahl, nickel-matt / Kunststoff, weiss
luminaire encastrable; acier, nickel mat / plastique, blanc

Ø 86, ET 26



2,7W 360lm

Ø 75



9 002759 991524



Ø 86

99153 FUEVA 5

recessed light; steel, satin nickel / plastic, white
Einbauleuchte; Stahl, nickel-matt / Kunststoff, weiss
luminaire encastrable; acier, nickel mat / plastique, blanc

Ø 117, ET 26



5,5W 700lm

Ø 105



9 002759 991531



Ø 117

99154 FUEVA 5

recessed light; steel, satin nickel / plastic, white
Einbauleuchte; Stahl, nickel-matt / Kunststoff, weiss
luminaire encastrable; acier, nickel mat / plastique, blanc

Ø 166, ET 26



10,5W 1350lm

Ø 155



9 002759 991548



Ø 166



99155

LED

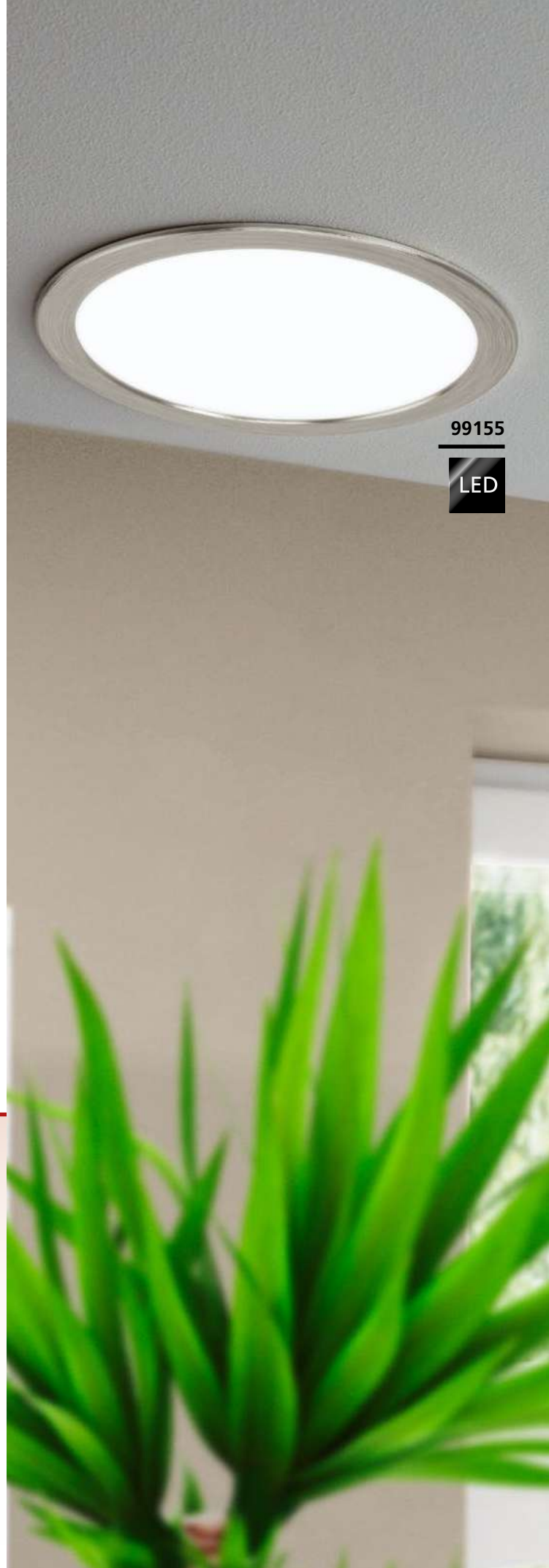

99155

LED

99155 FUEVA 5

recessed light; steel, satin nickel / plastic, white
Einbauleuchte; Stahl, nickel-matt / Kunststoff, weiss
luminaire encastrable; acier, nickel mat / plastique, blanc

Ø 216, ET 26

LED

16,5W

neutral
WHITE

2000lm



Ø205



9 002759 991555



Ø 216



99156

LED



99158

LED



99157

LED

99156 FUEVA 5

recessed light; steel, black / plastic, white
Einbauleuchte; Stahl, schwarz / Kunststoff, weiss
luminaire encastrable; acier, noir / plastique, blanc

Ø 86, ET 26



2,7W 360lm

Ø 75



9 002759 991562



Ø 86

99157 FUEVA 5

recessed light; steel, black / plastic, white
Einbauleuchte; Stahl, schwarz / Kunststoff, weiss
luminaire encastrable; acier, noir / plastique, blanc

Ø 117, ET 26



5,5W 700lm

Ø 105



9 002759 991579



Ø 117

99158 FUEVA 5

recessed light; steel, black / plastic, white
Einbauleuchte; Stahl, schwarz / Kunststoff, weiss
luminaire encastrable; acier, noir / plastique, blanc

Ø 166, ET 26



10,5W 1350lm

Ø 155



9 002759 991586



Ø 166



99159

LED

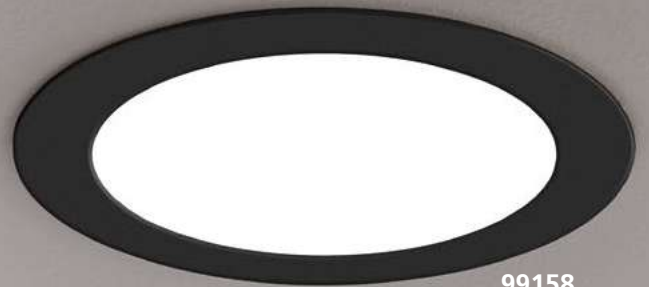

99158

LED

99159 FUEVA 5

recessed light; steel, black / plastic, white
Einbauleuchte; Stahl, schwarz / Kunststoff, weiss
luminaire encastrable; acier, noir / plastique, blanc

Ø 216, ET 26

LED

16,5 W

neutral
WHITE

2000lm



Ø 205



9 002759 991593



Ø 216

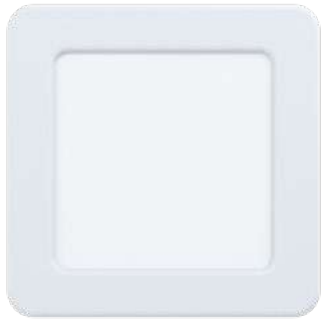

99162

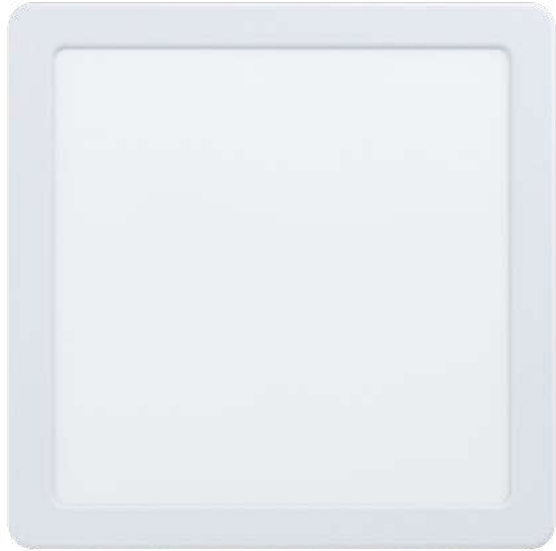

99164

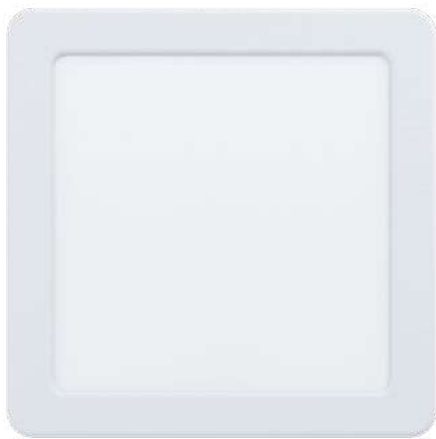

99163



99162 FUEVA 5

recessed light; steel, white / plastic, white
Einbauleuchte; Stahl, weiss / Kunststoff, weiss
luminaire encastrable; acier, blanc / plastique, blanc

L 117, B 117, ET 26



5,5W 650lm 105x105



9 002759 991623

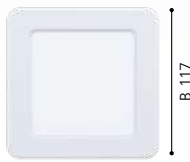

L 117



9 002759 991630



L 166, B 166, ET 26



10,5W 1200lm 155x155



L 166

99164 FUEVA 5

recessed light; steel, white / plastic, white
Einbauleuchte; Stahl, weiss / Kunststoff, weiss
luminaire encastrable; acier, blanc / plastique, blanc

L 216, B 216, ET 26



16,5W 1800lm 205x205



9 002759 991647

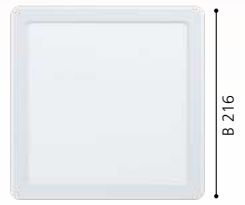

L 216



99167

LED



99169

LED



99168

LED

99167 FUEVA 5

recessed light; steel, satin nickel / plastic, white
Einbauleuchte; Stahl, nickel-matt / Kunststoff, weiss
luminaire encastrable; acier, nickel mat / plastique, blanc

L 117, B 117, ET 26



5,5W

650lm

105x105



9 002759 991678



L 117

B 117

99168 FUEVA 5

recessed light; steel, satin nickel / plastic, white
Einbauleuchte; Stahl, nickel-matt / Kunststoff, weiss
luminaire encastrable; acier, nickel mat / plastique, blanc

L 166, B 166, ET 26



10,5W

1200lm

155x155



9 002759 991685



L 166

B 166

99169 FUEVA 5

recessed light; steel, satin nickel / plastic, white
Einbauleuchte; Stahl, nickel-matt / Kunststoff, weiss
luminaire encastrable; acier, nickel mat / plastique, blanc

L 216, B 216, ET 26



16,5W

1800lm

205x205



9 002759 991692



L 216

B 216

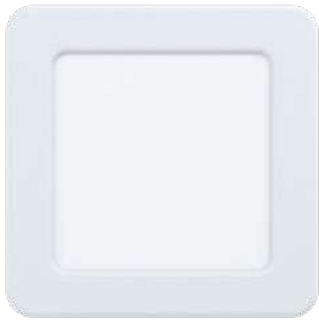

99178



99181

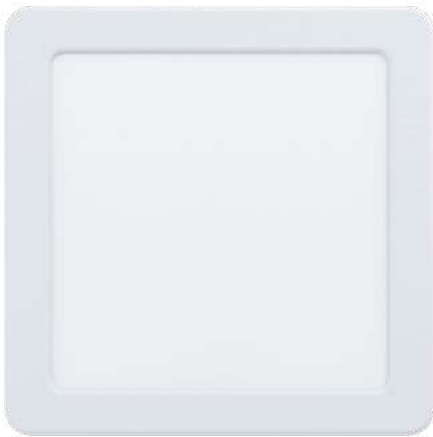

99179



99178 FUEVA 5

recessed light; steel, white / plastic, white
Einbauleuchte; Stahl, weiss / Kunststoff, weiss
luminaire encastrable; acier, blanc / plastique, blanc

L 117, B 117, ET 26



5,5W 700lm 105x105



9 002759 991784

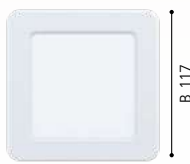

L 117



9 002759 991791



L 166, B 166, ET 26



10,5W 1350lm 155x155

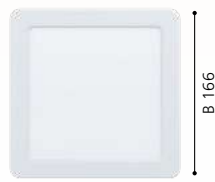

L 166

99181 FUEVA 5

recessed light; steel, white / plastic, white
Einbauleuchte; Stahl, weiss / Kunststoff, weiss
luminaire encastrable; acier, blanc / plastique, blanc

L 216, B 216, ET 26



16,5W 2000lm 205x205



9 002759 991814

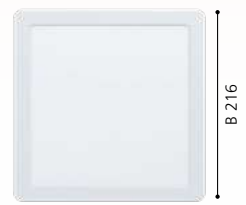

L 216

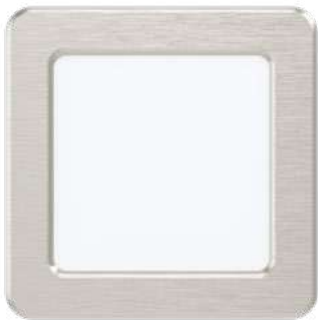

99183

LED



99185

LED



99184

LED

99183 FUEVA 5

recessed light; steel, satin nickel / plastic, white
Einbauleuchte; Stahl, nickel-matt / Kunststoff, weiss
luminaire encastrable; acier, nickel mat / plastique, blanc

L 117, B 117, ET 26

LED

5,5W

neutral
WHITE

700lm



105x105



99184 FUEVA 5

recessed light; steel, satin nickel / plastic, white
Einbauleuchte; Stahl, nickel-matt / Kunststoff, weiss
luminaire encastrable; acier, nickel mat / plastique, blanc

L 166, B 166, ET 26

LED

10,5W

neutral
WHITE

1350lm



155x155



99185 FUEVA 5

recessed light; steel, satin nickel / plastic, white
Einbauleuchte; Stahl, nickel-matt / Kunststoff, weiss
luminaire encastrable; acier, nickel mat / plastique, blanc

L 216, B 216, ET 26

LED

16,5W

neutral
WHITE

2000lm



205x205



9 002759 991838

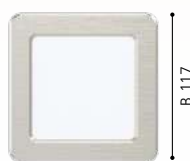

L 117

B 117



9 002759 991845



L 166

B 166



9 002759 991852



L 216

B 216



99187

LED





99187

LED

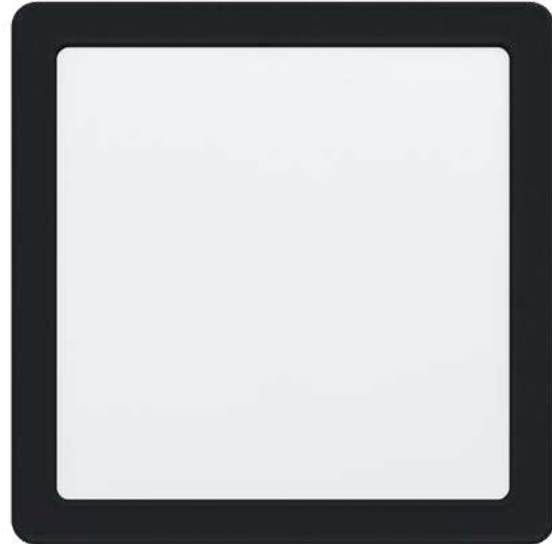

99189

LED

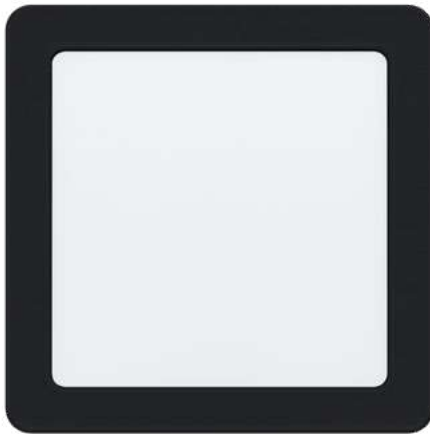

99188

LED

99187 FUEVA 5

recessed light; steel, black / plastic, white
Einbauleuchte; Stahl, schwarz / Kunststoff, weiss
luminaire encastrable; acier, noir / plastique, blanc

L 117, B 117, ET 26



5,5W 700lm 105x105

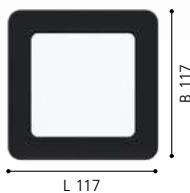

99188 FUEVA 5

recessed light; steel, black / plastic, white
Einbauleuchte; Stahl, schwarz / Kunststoff, weiss
luminaire encastrable; acier, noir / plastique, blanc

L 166, B 166, ET 26



10,5W 1350lm 155x155



99189 FUEVA 5

recessed light; steel, black / plastic, white
Einbauleuchte; Stahl, schwarz / Kunststoff, weiss
luminaire encastrable; acier, noir / plastique, blanc

L 216, B 216, ET 26



16,5W 2000lm 205x205

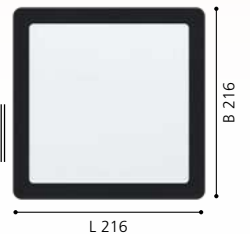



99191

LED





99191



99193



99192



99191 FUEVA 5

recessed light; steel, white / plastic, white
Einbauleuchte; Stahl, weiss / Kunststoff, weiss
luminaire encastrable; acier, blanc / plastique, blanc

Ø 117, ET 26



5,5W



650lm



Ø 105



9 002759 991913



Ø 117

99192 FUEVA 5

recessed light; steel, white / plastic, white
Einbauleuchte; Stahl, weiss / Kunststoff, weiss
luminaire encastrable; acier, blanc / plastique, blanc

Ø 166, ET 26



10,5W



1200lm



Ø 155



9 002759 991920



Ø 166

99193 FUEVA 5

recessed light; steel, white / plastic, white
Einbauleuchte; Stahl, weiss / Kunststoff, weiss
luminaire encastrable; acier, blanc / plastique, blanc

Ø 216, ET 26



16,5W



1800lm



Ø 205



9 002759 991937



Ø 216



99202



IP44



99203



IP44



99206



IP44

99202 FUEVA 5

recessed light; steel, white / plastic, white
Einbauleuchte; Stahl, weiss / Kunststoff, weiss
luminaire encastrable; acier, blanc / plastique, blanc

99206 FUEVA 5

recessed light; steel, white / plastic, white
Einbauleuchte; Stahl, weiss / Kunststoff, weiss
luminaire encastrable; acier, blanc / plastique, blanc

99203 FUEVA 5

recessed light; steel, white / plastic, white
Einbauleuchte; Stahl, weiss / Kunststoff, weiss
luminaire encastrable; acier, blanc / plastique, blanc

Ø 86, ET 26



2,7W



300lm



Ø 75



IP44



9 002759 992026



Ø 86

Ø 86, ET 26



2,7W



360lm



Ø 75



IP44



9 002759 992064



Ø 86

Ø 166, ET 26



10,5W



1200lm



Ø 155



IP44



9 002759 992033



Ø 166



99207



99207 FUEVA 5

recessed light; steel, white / plastic, white
 Einbauleuchte; Stahl, weiss / Kunststoff, weiss
 luminaire encastrable; acier, blanc / plastique, blanc

Ø 166, ET 26



9 002759 992071

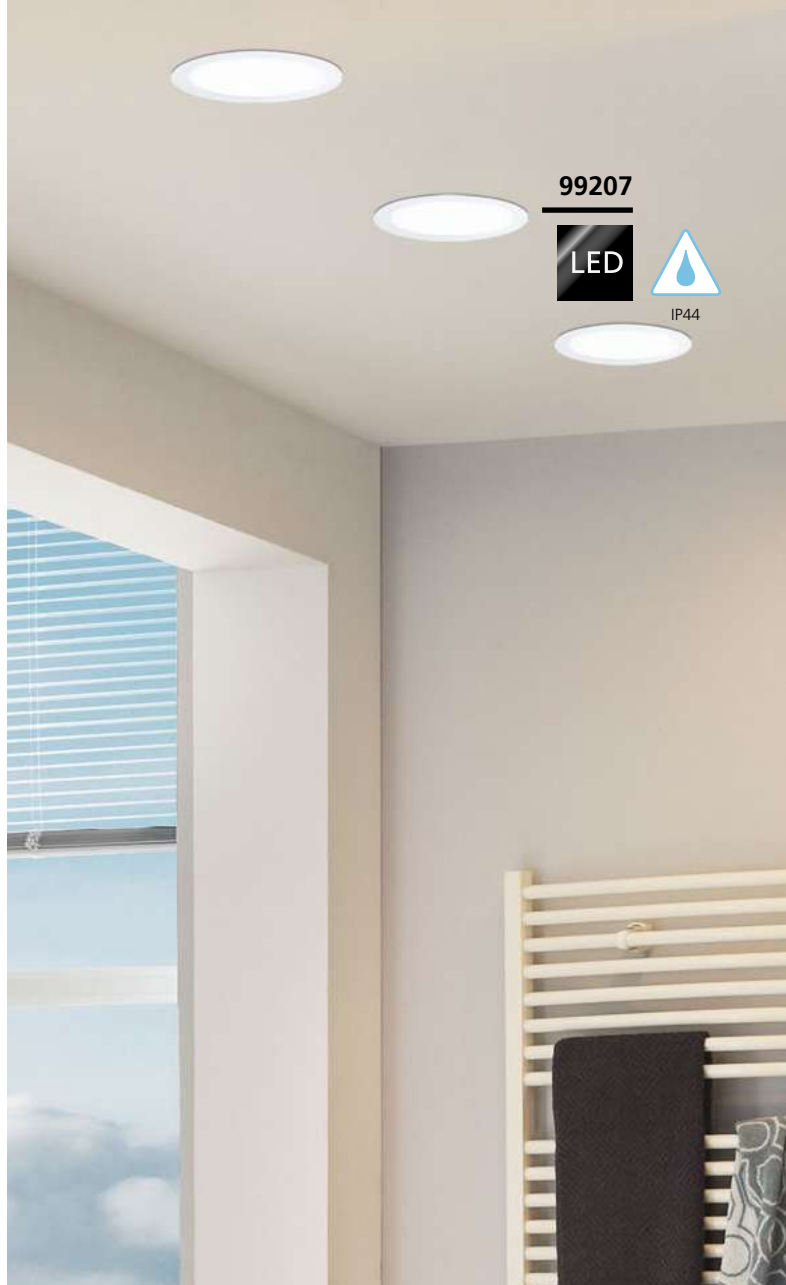

99207



IP44



FUEVA 5

These luminaires are protected against splash water.

Diese Leuchten sind gegen Spritzwasser geschützt.

Les luminaires sont protégées contre les éclaboussures d'eau.



IP44		EU	X	X	✓	✓
		FR	X	X	X	✓



99204



IP44



99205



IP44



99208



IP44

99204 FUEVA 5

recessed light; steel, chrome / plastic, white
Einbauleuchte; Stahl, chrom / Kunststoff, weiss
luminaire encastrable; acier, chrome / plastique, blanc

Ø 86, ET 26



2,7W 300lm Ø75 IP44



9 002759 992040



Ø 86

99208 FUEVA 5

recessed light; steel, chrome / plastic, white
Einbauleuchte; Stahl, chrom / Kunststoff, weiss
luminaire encastrable; acier, chrome / plastique, blanc

Ø 86, ET 26



2,7W 360lm Ø75 IP44



9 002759 992088



Ø 86

99205 FUEVA 5

recessed light; steel, chrome / plastic, white
Einbauleuchte; Stahl, chrom / Kunststoff, weiss
luminaire encastrable; acier, chrome / plastique, blanc

Ø 166, ET 26



10,5W 1200lm Ø155 IP44



9 002759 992057



Ø 166



99209



99209 FUEVA 5

recessed light; steel, chrome / plastic, white
Einbauleuchte; Stahl, chrom / Kunststoff, weiss
luminaire encastrable; acier, chrome / plastique, blanc

Ø 166, ET 26

LED

10,5W

neutral
WHITE

1350lm



Ø 155



IP44



Ø 166



9 002759 992095



99204



IP44



99211



IP44



99212



IP44



99213



IP44

99211 FUEVA 5

recessed light; steel, black / plastic, white
Einbauleuchte; Stahl, schwarz / Kunststoff, weiss
luminaire encastrable; acier, noir / plastique, blanc

Ø 86, ET 26



9 002759 992118



Ø 86

99213 FUEVA 5

recessed light; steel, black / plastic, white
Einbauleuchte; Stahl, schwarz / Kunststoff, weiss
luminaire encastrable; acier, noir / plastique, blanc

Ø 86, ET 26



9 002759 992132



Ø 86

99212 FUEVA 5

recessed light; steel, black / plastic, white
Einbauleuchte; Stahl, schwarz / Kunststoff, weiss
luminaire encastrable; acier, noir / plastique, blanc

Ø 166, ET 26



9 002759 992125



Ø 166



99214



99214 FUEVA 5

recessed light; steel, black / plastic, white
Einbauleuchte; Stahl, schwarz / Kunststoff, weiss
luminaire encastrable; acier, noir / plastique, blanc

Ø 166, ET 26



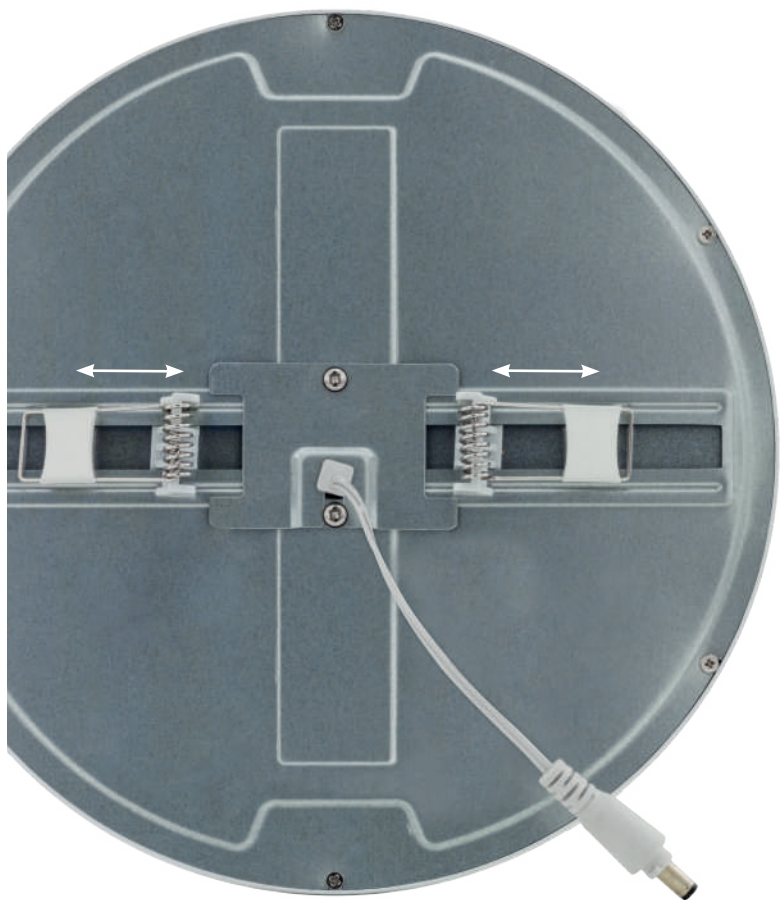

FUEVA FLEX

Flexible mounting bracket for various ceiling cut-outs from 50-210 mm.

Flexibler Einbaubügel für verschiedene Deckenausschnitte von 50-210 mm.

Support de montage flexible pour différentes découpes de plafond de 50 à 210 mm.



98865



98866



98867



98865 FUEVA FLEX

recessed light; aluminium, white / plastic, white
 Einbauleuchte; Alu, weiss / Kunststoff, weiss
 luminaire encastrable; aluminium, blanc / plastique, blanc

H 25, Ø 225



22W 2800lm

Ø 70-200

98866 FUEVA FLEX

recessed light; aluminium, satin nickel / plastic, white
 Einbauleuchte; Alu, nickel-matt / Kunststoff, weiss
 luminaire encastrable; aluminium, nickel mat / plastique, blanc

H 25, Ø 225



22W 2800lm

Ø 70-200

98867 FUEVA FLEX

recessed light; aluminium, black / plastic, white
 Einbauleuchte; Alu, schwarz / Kunststoff, weiss
 luminaire encastrable; aluminium, noir / plastique, blanc

H 25, Ø 225



22W 2800lm

Ø 70-200



9 002759 988654



Ø 225



9 002759 988661



Ø 225



9 002759 988678



Ø 225



98868



98869



98871



98871



98868 FUEVA FLEX

recessed light; aluminium, white / plastic, white
Einbauleuchte; Alu, weiss / Kunststoff, weiss
luminaire encastrable; aluminium, blanc / plastique, blanc

H 25, Ø 225



22W

2800lm

Ø 70-200



9 002759 988685



Ø 225

98869 FUEVA FLEX

recessed light; aluminium, satin nickel / plastic, white
Einbauleuchte; Alu, nickel-matt / Kunststoff, weiss
luminaire encastrable; aluminium, nickel mat / plastique, blanc

H 25, Ø 225



22W

2800lm

Ø 70-200



9 002759 988692



Ø 225

98871 FUEVA FLEX

recessed light; aluminium, black / plastic, white
Einbauleuchte; Alu, schwarz / Kunststoff, weiss
luminaire encastrable; aluminium, noir / plastique, blanc

H 25, Ø 225



22W

2800lm

Ø 70-200



9 002759 988715



Ø 225



RECESSED LUMINAIRES

LOW VOLTAGE

ADVANTAGES

- > SLIM DESIGN WITH MINIMAL INSTALLATION DEPTH, MAKING IT IDEAL FOR CEILING STRUCTURES WITH LITTLE SPACE
- > UNIFORM DISTRIBUTION OF LIGHT - IDEAL FOR ILLUMINATING SPACES AND SURFACES
- > LOW TEMPERATURE ENHANCES SAFETY
- > PLEASANT WARM WHITE LIGHT COLOR
- > LOW TEMPERATURE ENHANCES SAFETY
- > UP TO 80% POWER SAVINGS COMPARED TO INCANDESCENT LAMPS. EASY ON YOUR BUDGET AND THE ENVIRONMENT
- > IMPL. CABLING THROUGH INTEGRATED TERMINAL CONNECTOR ON DRIVER

VORTEILE

- > SCHLANKE BAUFORM MIT MINIMALER EINBAUTIEFE, DAHER IDEAL FÜR DECKEN-KONSTRUKTIONEN MIT WENIG PLATZ
- > HOMOGENE LICHTVERTEILUNG - IDEAL ZUR BELEUCHTUNG VON RÄUMEN UND FLÄCHEN
- > GERINGE WÄRMEENTWICKLUNG SORGT FÜR MEHR SICHERHEIT
- > BIS ZU 80% STROMERSPARNIS GEGENÜBER GLÜHLAMPEN, SCHONT IHR BUDGET UND DIE UMWELT
- > EINFACHE VERKABELUNG DURCH INTEGRIERTEN KLEMMANSCHLUSS AM TREIBER

ADVANTAGES

- > CONCEPTION MINCE AVEC LA PROFONDEUR D'INSTALLATION MINIMALE, IDÉAL POUR LES STRUCTURES DE PLAFOND AVEC PEU D'ESPACE
- > DISTRIBUTION UNIFORME DE LA LUMIÈRE - IDÉAL POUR L'ILLUMINATION DES ESPACES ET SURFACES
- > FAIBLE CHALEUR AMÉLIORE LA SÉCURITÉ
- > JUSQU'À 80% D'ÉCONOMIES D'ÉNERGIE PAR RAPPORT AUX LAMPES À INCANDESCENCE, RÉDUIT VOTRE BUDGET ET PROTÈGE L'ENVIRONNEMENT
- > BUDGET AND THE ENVIRONMENT
- > CÂBLAGE SIMPLE VIA LE CONNECTEUR DE TERMINAL INTÉGRÉ SUR CONDUCTEUR

OVERVIEW

5 year warranty
Jahre Garantie
ans de garantie
anni di garanzia
años de garantía



RONZANO 1
p. 170



FIOBBO
p. 172



FIOBBO
p. 172



CHANGO
p. 174



98521



98521 RONZANO 1

recessed light; steel, white, silver

Einbauleuchte; Stahl, weiss, silber

luminaire encastrable; acier, blanc, argent

Ø 165, ET 50

LED

5W

warm
WHITE

480lm



Ø145



9 002759 985219

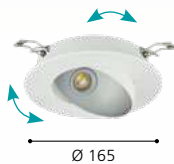

Ø 165



98521





97594

LED



97593

LED

97593 FIOBBO

recessed light; steel, white / plastic with crystal effect, white
 Einbauleuchte; Stahl, weiss / Kunststoff m. Kristalleffekt, weiss
 luminaire encastrable; acier, blanc / plastique avec effet cristal, blanc

H 50, Ø 225, ET 40



14W 1700lm

Ø205

97594 FIOBBO

recessed light; steel, white / plastic with crystal effect, white
 Einbauleuchte; Stahl, weiss / Kunststoff m. Kristalleffekt, weiss
 luminaire encastrable; acier, blanc / plastique avec effet cristal, blanc

H 50, Ø 300, ET 40



21W 2500lm

Ø280



9 002759 975937



Ø 225



9 002759 975944



Ø 300



97594

LED





97079



IP44

CHANGO

- | | | |
|---|--|--|
| <ul style="list-style-type: none"> > "Starry Sky" 3 Spot Set > Simple installation > Pre-assembled connecting box > Plug & Play > Desktop driver > Operable with 2 – 3 spotheads incl. short-connector > Cable length = 2m > Cutout dimension = 16 mm | <ul style="list-style-type: none"> > "Sternenhimmel" 3 Spot Set > Einfache Montage > Vorkonfigurierte Anschlußbox > Plug & Play > Desktop Treiber > Verwendbar mit 2 – 3 Spotköpfen inkl. Verbinder > Kabellänge = 2m > Ausschnitt Durchmesser = 16 mm | <ul style="list-style-type: none"> > Ensemble 3 spots " Ciel étoilé " > Installation simple > Boîte de connexion pré-assemblée > Branchez & jouez > Pilote de bureau > Utilisable avec 2 à 3 têtes incl. connecteur court > Longueur du câble = 2m > Cote de découpe = 16 mm |
|---|--|--|

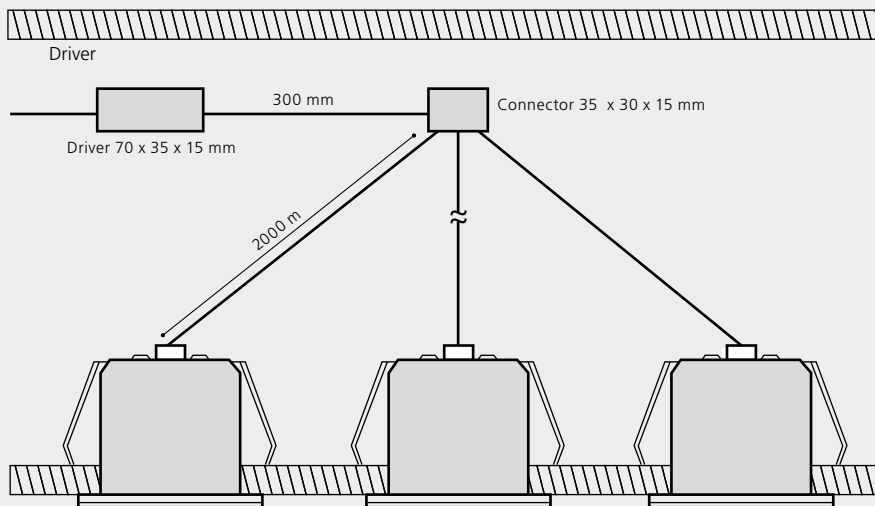

97079 CHANGO

recessed light; aluminium, white
 Einbauleuchte; Alu, weiss
 luminaire encastrable; aluminium, blanc

H 22, Ø 32, ET 25



3x 1W



3x 100lm



Ø 15



IP44



9 002759 970796





97079

LED



IP44

EGLO TRACK SYSTEMS

NEW AND MULTIFUNCTIONAL

ADVANTAGES

- > LED PHASE SYSTEMS ARE INCREASING IN POPULARITY, WHETHER IN LIVING SPACES OR AS ACCENT LIGHTING: NOWADAYS THEY ARE FOUND THROUGHOUT THE INTERIOR FINISH.
 - > LED LIGHTING PANELS AND LIGHT FIXTURES OFFER UNMATCHED FLEXIBILITY.
 - > EGLO HAS DEVELOPED TWO LED LIGHTING PANEL SYSTEMS:
EGLO TRACK PRO IS OUR COMPLEX LINEAR SYSTEM FOR THE TRADE SECTOR, NOW ADAPTED FOR DIY CUSTOMERS. HIGH-QUALITY, ROBUST MATERIALS GUARANTEE A LONG SERVICE LIFE.
EGLO TRACK BASIC IS THE MOST USER-FRIENDLY SINGLE-PHASE SYSTEM ON THE MARKET. ALL OUR EGLO TRACK SYSTEMS CAN BE USED TO SET THE SCENE IN A ROOM, SPACE OR AROUND AN OBJECT.
 - > THE NEW SYSTEM OFFERS DIVERSE, FLEXIBLE POSSIBILITIES FOR ILLUMINATING ARCHITECTURE, INTERIORS OR EVEN INDIVIDUAL OBJECTS TO THEIR BEST EFFECT AND CREATING ATMOSPHERE IN A ROOM.
-

VORTEILE

- > LED-PHASENSYSTEME FINDEN IMMER MEHR ANWENDUNG - IM WOHNRAUM, ODER AUCH ALS AKZENTBELEUCHTUNG - MITTLERWEILE ALSO IM GESAMTEN BEREICH DES INNENAUSBAUS.
 - > LED-LICHTLEISTEN UND LEUCHTEN SIND SO FLEXIBEL EINSETZBAR, WIE KEIN ANDERES LEUCHTMITTEL. EGLO HAT HIERBEI ZWEI SYSTEME ENTWICKELT:
EGLO TRACK PRO: DAS KOMPLEXE LINEARSYSTEM AUS DEM PROFESSIONALSEKTOR FÜR DIE DIY-KUNDEN. HOCHWERTIGE, ROBUSTE MATERIALIEN GARANTIEREN LANGLEBIGE PRODUKTE.
EGLO TRACK BASIC: DAS BEDIENERFREUNDLICHSTE EINPHASENSYSTEM AM MARKT. DIE EGLO TRACKSYSTEME ERMÖGLICHEN AUCH HIER GEZIELTE INSZENIERUNG VON RÄUMEN, FLÄCHEN ODER GEGENSTÄNDEN.
 - > INSGESAMT BIETET DAS NEUE SYSTEM VIELSEITIGE MÖGLICHKEITEN ARCHITEKTUR, INTERIEUR ABER AUCH EINZELNE GEGENSTÄNDE INS RICHTIGE LICHT ZU RÜCKEN UND DEN RAUM MIT ATMOSPHERE ZU FÜLLEN.
-

ADVANTAGES

- > LES SYSTÈMES DE PHASES LED SONT DE PLUS EN PLUS UTILISÉS DANS LA DÉCORATION INTÉRIEURE : COMME ÉCLAIRAGE PRINCIPAL DANS LES PIÈCES DE VIE OU COMME ÉCLAIRAGE D'APPOINT.
- > LES LUMINAIRES ET LES RAILS À LED SONT PLUS FLEXIBLES QUE TOUTE AUTRE SOURCE DE LUMIÈRE. EGLO A DÉVELOPPÉ DEUX SYSTÈMES.
EGLO TRACK PRO : LE SYSTÈME LINÉAIRE COMPLEXE DU SECTEUR PROFESSIONNEL POUR LES CLIENTS PARTICULIERS. DES MATÉRIAUX ROBUSTES DE HAUTE QUALITÉ GARANTISSENT LA LONGÉVITÉ DES PRODUITS.
EGLO TRACK BASIC : LE SYSTÈME MONOPHASÉ LE PLUS CONVIVAL DU MARCHÉ. LES SYSTÈMES DE RAILS EGLO PERMETTENT ÉGALEMENT DE METTRE EN AVANT DE MANIÈRE CIBLÉE DES PIÈCES, DES SURFACES OU DES OBJETS.
- > AINSI, CE NOUVEAU SYSTÈME OFFRE DE NOMBREUSES POSSIBILITÉS POUR METTRE EN LUMIÈRE L'ARCHITECTURE, L'INTÉRIEUR OU ENCORE LES OBJETS ET DONNER UNE CERTAINE AMBIANCE À UNE PIÈCE.

























OVERVIEW

5 year warranty
 Jahre Garantie
 anni di garanzia
 años de garantía
 años de garantía

EGLO TRACK SYSTEMS **BASIC**

 TB TRACK S p. 180	 TB TRACK L p. 180	 TB CONNECTOR p. 180	 TB MIDDLE FEEDER p. 181	 TB CORNER CONNECT p. 181	 TB ADAPTER p. 181	 TB TRACK S p. 182	 TB TRACK L p. 182
 TB CONNECTOR p. 182	 TB MIDDLE FEEDER p. 183	 TB CORNER CONNECT p. 183	 TB ADAPTER p. 183	 TB NEWTOWN p. 184	 TB CASIBARE p. 184	 TB CORTENOVA p. 184	 TB CORTENOVA p. 185
 TB CORTADERAS p. 185	 TB CORTADERAS p. 185	 TB SERAS p. 186	 TB SERAS p. 186	 TB SPOTLIGHT p. 186	 TB SPOTLIGHT p. 187	 TB SET p. 187	 TB SET p. 187

EGLO TRACK SYSTEMS **PRO**

 TP TRACK p. 190	 TP TRACK p. 190	 TP TRACK p. 190	 TP CUBE CONNECTOR p. 191	 TP CUBE CONNECTOR p. 191	 TP CUBE CONNECTOR p. 191	 TP LIGHT INSERT S p. 192	 TP LIGHT INSERT L p. 192
 TP BLIND COVER S p. 194	 TP BLIND COVER S p. 194	 TP BLIND COVER S p. 194	 TP BLIND COVER L p. 195	 TP BLIND COVER L p. 195	 TP BLIND COVER L p. 195	 TP SUSPENSION p. 196	 TP CANOPY p. 197
 TP CANOPY p. 197	 TP CANOPY p. 197	 TP PENDANT LIGHT p. 198	 TP PENDANT LIGHT p. 198	 TP PENDANT LIGHT p. 198	 TP DOWNLIGHT p. 200	 TP DOWNLIGHT p. 200	 TP DOWNLIGHT p. 200
 TP SPOTLIGHT p. 201	 TP SPOTLIGHT p. 201	 TP SPOTLIGHT p. 201					

EGLO TRACK SYSTEMS

BASIC

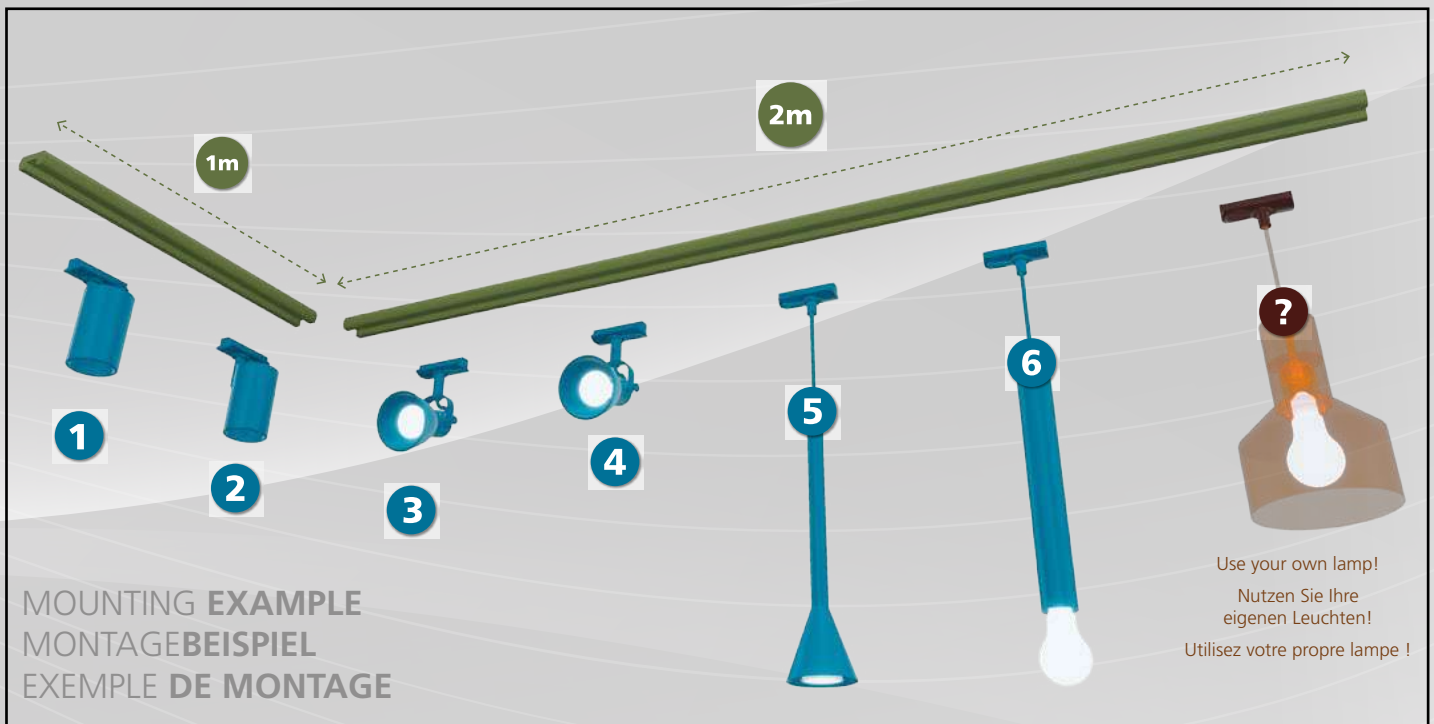

IN GENERAL/ ALLGEMEINES/ CARACTÉRISQUES GÉNÉRALES

- > the most user-friendly product/ Das nutzerfreundlichste Produkt/ Particulièrement ergonomique.
- > lighting-highlights have been adapted, and are now ready to use with the **BASIC** system./ Die Spots wurden angepasst und können nun mit dem BASIC-System verwendet werden./ Les principales propriétés d'éclairage ont été adaptées et peuvent maintenant être utilisées avec le système BASIC.
- > left- and right mounting with flexible **corner-connector**. Use the straight connector to attach the track in line./ Links- und Rechtsmontage mit flexiblem Eckverbinder. Verwenden Sie den geraden Verbinder, um die Schienen (Tracks) in Reihe zu verbinden/ Montage à gauche et à droite grâce au connecteur coudé flexible. Utilisez le connecteur droit pour fixer le rail en ligne droite.
- > available in the trend colors:/ verfügbar in den Trendfarben:/ Disponible en deux coloris tendance :

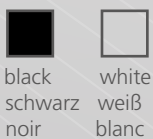

EGLO TRACK **BASIC**

1

You can get the track in two different sizes: 1m + 2m. Install them on the ceiling and connect the tracks (left, right or straight) by using the flexible corner connector.

Sie können die Tracks in zwei verschiedenen Größen erhalten: 1 m + 2 m. Montieren Sie sie an der Decke und verbinden Sie die Tracks mithilfe des flexiblen Eckverbinders nach links, rechts oder geradeaus.

Rail disponible en deux tailles : 1 m + 2 m. Montez-les au plafond et connectez les rails à gauche, à droite ou tout droit à l'aide du connecteur d'angle flexible.

2

Choose your favourite LIGHT FIXTURES by clicking them into the track, easily.

Wählen Sie Ihre bevorzugten Beleuchtungselemente, indem Sie sie einfach in die Schiene einklicken.

Choisissez vos luminaires préférés et clipsez-les facilement dans le rail.

3

STAY FLEXIBLE - use the adapter to hang in a lamp, that you have at home.

Blieben sie flexibel - verwenden Sie den Adapter, um eine bereits vorhandene Leuchte einzuhängen,.

Une flexibilité en toutes Circonstances : si vous avez déjà une lampe chez vous, utilisez l'adaptateur pour la suspendre.



ADVANTAGES

- > THE SINGLE-PHASE SYSTEM IS THE MOST USER-FRIENDLY PRODUCT ON THE MARKET.
 - > USE THE EGLO TRACK SYSTEMS TO SET THE SCENE IN A ROOM, SPACE OR AROUND AN OBJECT.
 - > EGLO'S DECORATIVE HIGHLIGHTS FOR LIVING SPACES HAVE BEEN INTEGRATED INTO THE SINGLE-PHASE SYSTEM. AN ADAPTER IS AVAILABLE THAT LETS YOU INTEGRATE YOUR OWN LIGHT FIXTURES INTO THE SYSTEM.
 - > THE LONGITUDINAL CONNECTORS ON THE RAIL SYSTEM MAKE IT SUPERBLY EASY TO EXTEND.
 - > THE SYSTEM ALSO HAS FLEXIBLE CORNER CONNECTORS WITH BALL JOINTS, SO THAT IT CAN EASILY BE INSTALLED ON THE LEFT OR RIGHT.
 - > OUR HANDY STARTER SET PERFECTLY ROUNDS OFF OUR PRODUCT RANGE.
-

VORTEILE

- > DAS EINPHASENSYSTEM IST DAS BEDIENERFREUNDLICHSTE PRODUKT AM MARKT.
 - > DIE EGLO TRACKSYSTEME ERMÖGLICHEN GEZIELTE INSZENIERUNG VON RÄUMEN, FLÄCHEN ODER GEGENSTÄNDEN.
 - > EGLO'S DEKORATIVE HIGHLIGHTS AUS DEM WOHNBEREICH WURDEN IN DAS EINPHASENSYSTEM INTEGRIERT. MITHILFE DES ADAPTERS KANN MAN EIGENE LEUCHTEN IN DAS SYSTEM EINSPEISEN.
 - > DAS SCHIENENSYSTEM LÄSST SICH MIT DEM LÄNGSVERBINDER KINDERLEICHT VERLÄNGERN.
 - > DER FLEXIBLE ECKVERBINDER MIT KUGELGELENK ERMÖGLICHT EINE EINFACHE LINKS- ODER RECHTSMONTAGE.
 - > DAS PRAKTISCHE EINSTEIGERSET RUNDET DIE PRODUKTPALETTE PERFEKT AB.
-

ADVANTAGES

- > LE SYSTÈME MONOPHASÉ EST LE PRODUIT LE PLUS CONVIVAL DU MARCHÉ.
- > LES SYSTÈMES DE RAILS EGLO PERMETTENT UNE MISE EN SCÈNE CIBLÉE DES PIÈCES, DES ESPACES OU DES OBJETS.
- > LES ÉLÉMENTS DÉCORATIFS D'EGLO POUR L'INTÉRIEUR ONT ÉTÉ INTÉGRÉS AU SYSTÈME MONOPHASÉ. GRÂCE À L'ADAPTATEUR, IL EST POSSIBLE D'INTÉGRER SES PROPRES LUMIÈRES AU SYSTÈME.
- > LE SYSTÈME DE RAILS PEUT ÊTRE FACILEMENT ÉTENDU GRÂCE AU CONNECTEUR LONGITUDINAL.
- > LE CONNECTEUR D'ANGLE FLEXIBLE AVEC ROTULE PERMET UN MONTAGE FACILE À GAUCHE OU À DROITE.
- > LE KIT DE DÉMARRAGE PRATIQUE COMPLÈTE PARFAITEMENT LA GAMME DE PRODUITS.



99735



99734

99734, 99735

These items come with a power feed and end cap included.

Diese Artikel enthalten als Zubehör Einspeisung und Endkappe.

Ces articles comprennent l'alimentation et l'embout comme accessoires.



99737

99734 TB TRACK S

accessory; aluminium, white
Zubehör; Alu, weiss
accessoire; aluminium, blanc

L 1000, B 35, H 20

99735 TB TRACK L

accessory; aluminium, white
Zubehör; Alu, weiss
accessoire; aluminium, blanc

L 2000, B 35, H 20

99737 TB CONNECTOR

accessory; plastic, white
Zubehör; Kunststoff, weiss
accessoire; plastique, blanc

L 81, B 35, H 23



9 002759 997342

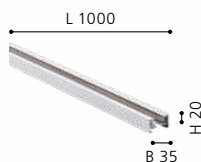

9 002759 997359



9 002759 997373





99738



99736



99739

99738 TB MIDDLE FEEDER

accessory; plastic, white
Zubehör; Kunststoff, weiss
accessoire; plastique, blanc

L 143, B 34, H 20

99739 TB CORNER CONNECT

accessory; plastic, white
Zubehör; Kunststoff, weiss
accessoire; plastique, blanc

L 276, B 34, H 20

99736 TB ADAPTER

accessory; plastic, white
Zubehör; Kunststoff, weiss
accessoire; plastique, blanc

L 81, B 39, H 71



9 002759 997380



9 002759 997397



9 002759 997366





99743



99742

99742, 99743

These items come with a power feed and end cap included.

Diese Artikel enthalten als Zubehör Einspeisung und Endkappe.

Ces articles contiennent une alimentation et un embout comme accessoires.



99745

99742 TB TRACK S

accessory; aluminium, black
Zubehör; Alu, schwarz
accessoire; aluminium, noir

L 1000, B 35, H 20

99743 TB TRACK L

accessory; aluminium, black
Zubehör; Alu, schwarz
accessoire; aluminium, noir

L 2000, B 35, H 20

99745 TB CONNECTOR

accessory; plastic, black
Zubehör; Kunststoff, schwarz
accessoire; plastique, noir

L 81, B 35, H 23

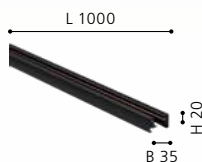



99746



99744



99747

99746 TB MIDDLE FEEDER

accessory; plastic, black
Zubehör; Kunststoff, schwarz
accessoire; plastique, noir

L 143, B 34, H 20

99747 TB CORNER CONNECT

accessory; plastic, black
Zubehör; Kunststoff, schwarz
accessoire; plastique, noir

L 276, B 34, H 20

99744 TB ADAPTER

accessory; plastic, black
Zubehör; Kunststoff, schwarz
accessoire; plastique, noir

L 81, B 39, H 71



9 002759 997465



L 143



9 002759 997472



L 276



9 002759 997441



L 81



99761



99757



99753

99761 TB NEWTOWN

pendant light; plastic, black / steel, black
 Hängeleuchte; Kunststoff, schwarz / Stahl, schwarz
 luminaire en suspension; plastique, noir / acier, noir

H 1100, Ø 160



E27 1x 40W



9 002759 997618



99757 TB CASIBARE

pendant light; plastic, black / steel, black
 Hängeleuchte; Kunststoff, schwarz / Stahl, schwarz
 luminaire en suspension; plastique, noir / acier, noir

H 1100, Ø 150

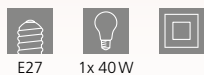

E27 1x 40W



9 002759 997571



99753 TB CORTENOVA

pendant light; plastic, white / steel, white
 Hängeleuchte; Kunststoff, weiss / Stahl, weiss
 luminaire en suspension; plastique, blanc / acier, blanc

H 1100, Ø 40



E27 1x 40W



9 002759 997533

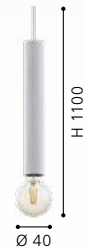



99758



99754



99759

**99753, 99754, 99757, 99758,
99759, 99761**

Adapter included.

Inklusive Adapter.

Adapteur inclus.

99758 TB CORTENOVA

pendant light; plastic, black / steel, black
Hängeleuchte; Kunststoff, schwarz / Stahl, schwarz
luminaire en suspension; plastique, noir / acier, noir

H 1100, Ø 40



E27 1x 40W



9 002759 997588



99754 TB CORTADERAS

pendant light; plastic, white / steel, white
Hängeleuchte; Kunststoff, weiss / Stahl, weiss
luminaire en suspension; plastique, blanc / acier, blanc

H 1500, Ø 85

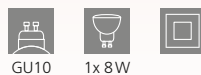

GU10 1x 8W



9 002759 997540



99759 TB CORTADERAS

pendant light; plastic, black / steel, black
Hängeleuchte; Kunststoff, schwarz / Stahl, schwarz
luminaire en suspension; plastique, noir / acier, noir

H 1500, Ø 85

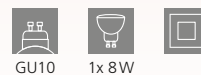

GU10 1x 8W



9 002759 997595

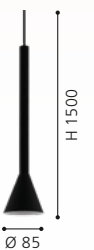



99755



99749



99751

99749 TB SERAS

spot; plastic, white / steel, white
Spot; Kunststoff, weiss / Stahl, weiss
spot; plastique, blanc / acier, blanc

H 165, Ø 85

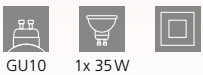

GU10 1x 35W



9 002759 997496



99755 TB SERAS

spot; plastic, black / steel, black
Spot; Kunststoff, schwarz / Stahl, schwarz
spot; plastique, noir / acier, noir

H 165, Ø 85

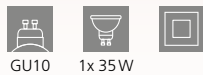

GU10 1x 35W



9 002759 997557



99751 TB SPOTLIGHT

spot; plastic, white / steel, white
Spot; Kunststoff, weiss / Stahl, weiss
spot; plastique, blanc / acier, blanc

L 80, B 85, H 150



GU10 1x 5W



9 002759 997519





99756 TB SPOTLIGHT

spot; plastic, black / steel, black
Spot; Kunststoff, schwarz / Stahl, schwarz
spot; plastique, noir / acier, noir

L 80, B 85, H 150



GU10 1x 5W



9 002759 997564



99762 TB SET

system; aluminium, plastic, white / steel, white
System; Alu, Kunststoff, weiss / Stahl, weiss
système; aluminium, plastique, blanc / acier, blanc

L 1000

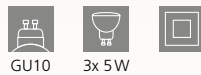

GU10 3x 5W



9 002759 997625



99763 TB SET

system; aluminium, plastic, black / steel, black
System; Alu, Kunststoff, schwarz / Stahl, schwarz
système; aluminium, plastique, noir / acier, noir

L 1000



GU10 3x 5W



9 002759 997632



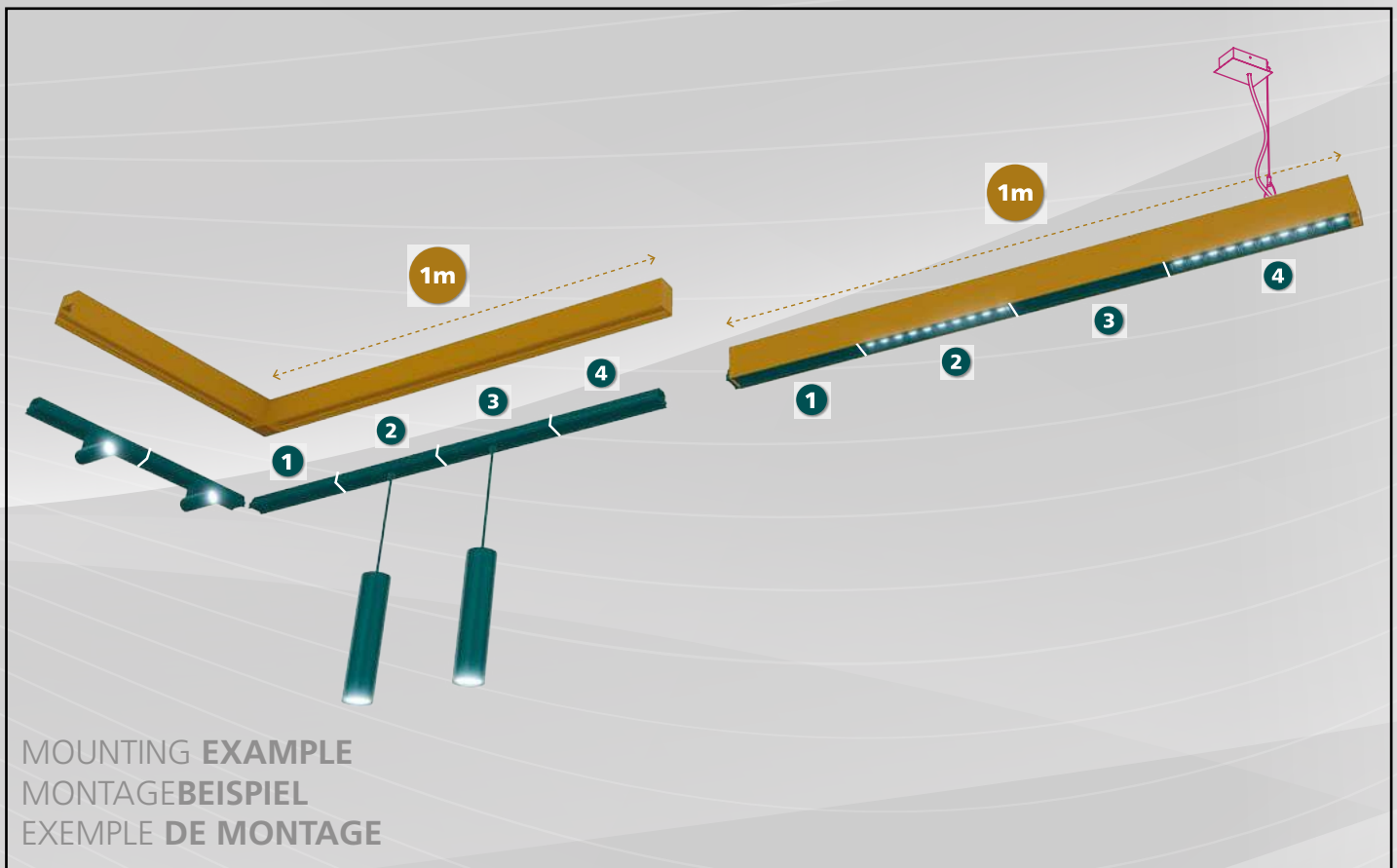

EGLO TRACK SYSTEMS

PRO



IN GENERAL/ ALLGEMEINES/ CARACTÉRISQUES GÉNÉRALES

- > the track has already installed a 24V driver and includes two endcovers and two connectors./ Die Schiene hat bereits einen 24V-Trafo installiert und enthält zwei Endabdeckungen und zwei Anschlüsse./Le rail est équipé d'un driver 24 V et inclut deux embouts et deux connecteurs.
- > mount it easily around corners with the connection cube./ Kann mit dem Verbindungswürfel leicht über das Eck montiert werden./ Peut être facilement monté dans les coins grâce au domino de raccordement.
- > can be fixed on the ceiling or optionally suspended./ Kann an der Decke oder optional abhängig befestigt werden. / Peut être fixé au plafond ou suspendu en option devenir.
- > all products in 3 different colors./ Alle Produkte in 3 verschiedenen Farben erhältlich: / Tous les produits sont disponibles en 3 coloris différents :

		
aluminum Aluminium aluminium	black Schwarz noir	white Weiß blanc

EGLO TRACK PRO

1

You can fix as many rails as you want next to each other. Size: 1062,5 mm.

Sie können beliebig viele Tracks nebeneinander befestigen. Größe: 1062,5 mm.

Vous pouvez fixer autant de rails que vous le souhaitez les uns à côté des autres. Taille : 1 062,5 mm.

2

1 Track = max. 4 modules: choose out of 4 spotsolutions or use the end-to-end light insert for a complete illumination.

1 Track = max. 4 Module: Wählen Sie aus 4 Spot-Lösungen oder verwenden Sie den durchgängigen Leuchteinsatz für eine komplette Ausleuchtung.

1 rail = 4 modules maximum : choisissez parmi 4 solutions de spots ou utilisez un insert lumineux de bout en bout pour un éclairage complet.

3

Use the appropriate accessories to get the most out of the track PRO system.

Verwenden Sie das entsprechende Zubehör, um das Track PRO-System optimal zu nutzen.

Utilisez les accessoires appropriés pour tirer le meilleur parti de votre système de rail PRO.



ADVANTAGES

- > WE'VE TAKEN THE FLEXIBLE LINEAR SYSTEM FROM THE TRADE SECTOR AND REDESIGNED IT FOR DIY CUSTOMERS.
 - > WE USE HIGH-QUALITY, ROBUST MATERIALS TO ENSURE A LONG SERVICE LIFE.
 - > ALL OUR RAILS INCLUDE A 24V DRIVER. EACH RAIL HAS ROOM FOR UP TO FOUR LIGHT INSERTS. THE LIGHT INSERTS ARE AVAILABLE IN TWO LENGTHS.
 - > THE SYSTEM CAN BE EXTENDED PRACTICALLY AND UNOBTRUSIVELY IN ALL DIRECTIONS USING A CONNECTING CUBE.
 - > INSTALL THE SYSTEM EITHER DIRECTLY ON THE CEILING OR SUSPENDED, AS PREFERRED.
 - > THE LIGHT INSERTS HAVE BEEN DESIGNED TO HARMONISE WITH THE SYSTEM FOR AN ELEGANT, TIMELESS EFFECT.
-

VORTEILE

- > DAS VIELSEITIGE LINEARSYSTEM AUS DEM PROFESSIONAL BEREICH - NUN FÜR DEN DIY MARKT KONZIPIERT.
 - > HOCHWERTIGE, ROBUSTE MATERIALIEN GARANTIEREN LANGLEBIGE PRODUKTE. ALLE SCHIENEN HABEN EINEN 24V TREIBER VERBAUT.
 - > JEDE SCHIENE BIETET PLATZ FÜR BIS ZU 4 LICHEINSÄTZE. DIE LICHEINSÄTZE SIND IN ZWEI VERSCHIEDENEN LÄNGEN ERHÄLTlich.
 - > EIN VERBINDUNGSWÜRFEL ERMÖGLICHT EINE DEZENTE UND UNAUFFÄLLIGE ERWEITERUNG IN ALLE RICHTUNGEN.
 - > DAS SYSTEM KANN ENTWEDER DIREKT AN DER DECKE ODER WAHLWEISE ABGEHÄNGENT MONTIERT WERDEN.
 - > DAS STIMMIGE DESIGN DER LICHEINSÄTZE WIRKT ELEGANT UND ZEITLOS.
-

ADVANTAGES

- > LE SYSTÈME LINÉAIRE POLYVALENT DE LA GAMME PROFESSIONNELLE - DÉSORMAIS CONÇU POUR LE MARCHÉ DES PARTICULIERS.
- > DES MATÉRIAUX ROBUSTES DE HAUTE QUALITÉ GARANTISSENT LA LONGÉVITÉ DES PRODUITS.
- > TOUS LES RAILS SONT DOTÉS D'UN DRIVER 24 V. CHAQUE RAIL PEUT ACCUEILLIR JUSQU'À 4 INSERTS LUMINEUX. LES INSERTS LUMINEUX SONT DISPONIBLES EN DEUX LONGUEURS DIFFÉRENTES.
- > UN DOMINO DE RACCORDEMENT PERMET UNE EXTENSION DISCRÈTE DANS TOUTES LES DIRECTIONS.
- > LE SYSTÈME PEUT ÊTRE MONTÉ DIRECTEMENT AU PLAFOND OU SUSPENDU.
- > LES INSERTS LUMINEUX ONT UN DESIGN ÉLÉGANT ET INTEMPOREL.



98821



98822

TP TRACK

24V driver included.

Inklusive 24V Treiber.

Pilote 24V inclus.



98823

98821 TP TRACK

system; aluminium, black
System; Alu, schwarz
système; aluminium, noir

L 1144, B 46, H 68



98822 TP TRACK

system; aluminium, white
System; Alu, weiss
système; aluminium, blanc

L 1144, B 46, H 68



98823 TP TRACK

system; aluminium, anodised aluminium
System; Alu, alu eloxiert
système; aluminium, aluminium anodisé

L 1144, B 46, H 68



9 002759 988210



L 1144



9 002759 988227



L 1144



9 002759 988234



L 1144



98801

TP CUBE CONNECTOR

Accessories: 4 connectors and 3 end caps.

Zubehör: 4 Verbindungsstücke und 3 Endkappen.

Accessoires : 4 connecteurs et 3 embouts.



98802

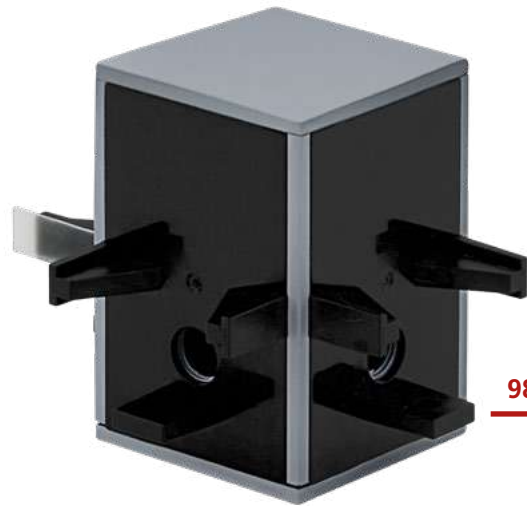

98803

98801 TP CUBE CONNECTOR

accessory; plastic, aluminium, black
Zubehör; Kunststoff, Alu, schwarz
accessoire; plastique, aluminium, noir

L 61, B 76, H 68

98802 TP CUBE CONNECTOR

accessory; plastic, aluminium, black, white
Zubehör; Kunststoff, Alu, schwarz, weiss
accessoire; plastique, aluminium, noir, blanc

L 61, B 76, H 68

98803 TP CUBE CONNECTOR

accessory; plastic, aluminium, black, anodised aluminium
Zubehör; Kunststoff, Alu, schwarz, alu eloxiert
accessoire; plastique, aluminium, noir, aluminium anodisé

L 61, B 76, H 68



9 002759 988012

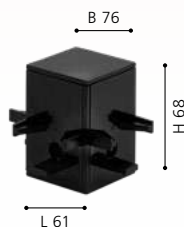

9 002759 988029

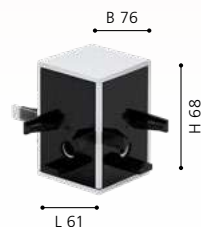

9 002759 988036

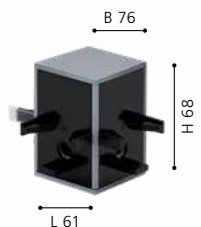



98808



98809



98808 TP LIGHT INSERT S

system; aluminium, aluminium / plastic, white
 System; Alu, alu / Kunststoff, weiss
 système; aluminium, aluminium / plastique, blanc

L 285, B 46, H 39



6,5W 780lm

98809 TP LIGHT INSERT L

system; aluminium, aluminium / plastic, white
 System; Alu, alu / Kunststoff, weiss
 système; aluminium, aluminium / plastique, blanc

L 1140, B 46, H 39



4x 6,5W 3120lm



9 002759 988081



9 002759 988098





98808





98824 TP BLIND COVER S

accessory; aluminium, black
Zubehör; Alu, schwarz
accessoire; aluminium, noir

L 142, B 44, H 14

98825 TP BLIND COVER S

accessory; aluminium, white
Zubehör; Alu, weiss
accessoire; aluminium, blanc

L 142, B 44, H 14

98826 TP BLIND COVER S

accessory; aluminium, anodised aluminium
Zubehör; Alu, alu eloxiert
accessoire; aluminium, aluminium anodisé

L 142, B 44, H 14





98827



98828



98829

98827 TP BLIND COVER L

accessory; aluminium, black
Zubehör; Alu, schwarz
accessoire; aluminium, noir

L 285, B 44, H 14

98828 TP BLIND COVER L

accessory; aluminium, white
Zubehör; Alu, weiss
accessoire; aluminium, blanc

L 285, B 44, H 14

98829 TP BLIND COVER L

accessory; aluminium, anodised aluminium
Zubehör; Alu, alu eloxiert
accessoire; aluminium, aluminium anodisé

L 285, B 44, H 14

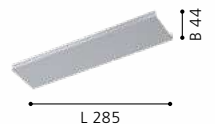



98807

98804



98804

98804 TP SUSPENSION

accessory; steel, silver
Zubehör; Stahl, silber
accessoire; acier, argent

H 2035, Ø 15





98806



98805



98807

98805 TP CANOPY

accessory; steel, plastic, black
Zubehör; Stahl, Kunststoff, schwarz
accessoire; acier, plastique, noir

L 110, B 110, H 2025

98806 TP CANOPY

accessory; steel, plastic, white
Zubehör; Stahl, Kunststoff, weiss
accessoire; acier, plastique, blanc

L 110, B 110, H 2025

98807 TP CANOPY

accessory; steel, plastic, silver
Zubehör; Stahl, Kunststoff, silber
accessoire; acier, plastique, argent

L 110, B 110, H 2025



H 2025



H 2025



H 2025



98811

LED



98812

LED



98813

LED

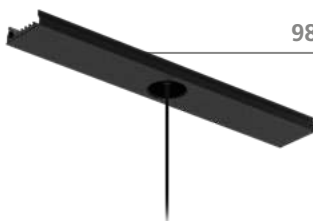

98811, 99912, 98813

Track insert included.

Inklusive Schieneneinsatz.

Insert de rail inclus.

98811 TP PENDANT LIGHT

pendant light; aluminium, plastic, black
Hängeleuchte; Alu, Kunststoff, schwarz
luminaire en suspension; aluminium, plastique, noir

L 285, B 44, H 2015, Ø 40



1x 9W 1200lm



9 002759 988111



Ø 40

98812 TP PENDANT LIGHT

pendant light; aluminium, plastic, white
Hängeleuchte; Alu, Kunststoff, weiss
luminaire en suspension; aluminium, plastique, blanc

L 285, B 44, H 2015, Ø 40



1x 9W 1200lm



9 002759 988128



Ø 40

98813 TP PENDANT LIGHT

pendant light; aluminium, plastic, anodised aluminium
Hängeleuchte; Alu, Kunststoff, alu eloxiert
luminaire en suspension; aluminium, plastique, aluminium anodisé

L 285, B 44, H 2015, Ø 40



1x 9W 1200lm



9 002759 988135



Ø 40



98811

LED



98814

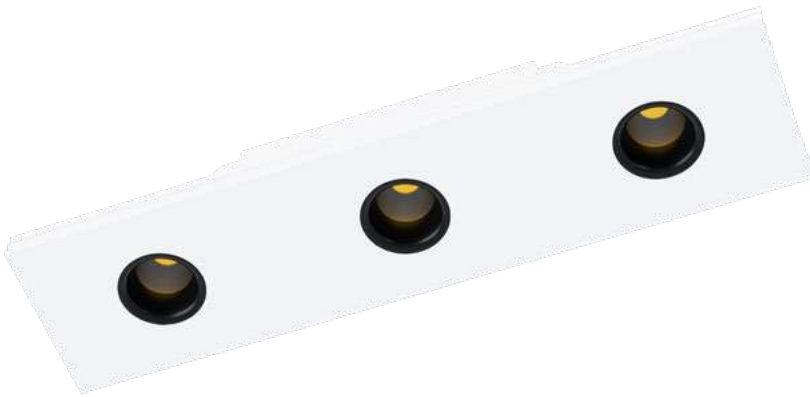

98815



98816



98814 TP DOWNLIGHT

system; aluminium, plastic, black
System; Alu, Kunststoff, schwarz
système; aluminium, plastique, noir

L 285, B 44, H 34



3x 3,5W 1530lm



9 002759 988142



98815 TP DOWNLIGHT

system; aluminium, plastic, white
System; Alu, Kunststoff, weiss
système; aluminium, plastique, blanc

L 285, B 44, H 34



3x 3,5W 1530lm



9 002759 988159

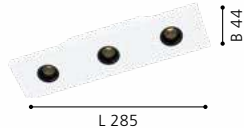

98816 TP DOWNLIGHT

system; aluminium, plastic, anodised aluminium
System; Alu, Kunststoff, alu eloxiert
système; aluminium, plastique, aluminium anodisé

L 285, B 44, H 34



3x 3,5W 1530lm



9 002759 988166





98817



98818



98819



98817 TP SPOTLIGHT

system; aluminium, plastic, black
 System; Alu, Kunststoff, schwarz
 système; aluminium, plastique, noir

L 285, B 44, H 95



1x 9W 1200lm



9 002759 988173



L 285

98818 TP SPOTLIGHT

system; aluminium, plastic, white
 System; Alu, Kunststoff, weiss
 système; aluminium, plastique, blanc

L 285, B 44, H 95



1x 9W 1200lm



9 002759 988180



L 285

98819 TP SPOTLIGHT

system; aluminium, plastic, anodised aluminium
 System; Alu, Kunststoff, alu eloxiert
 système; aluminium, plastique, aluminium anodisé

L 285, B 44, H 95



1x 9W 1200lm



9 002759 988197



L 285

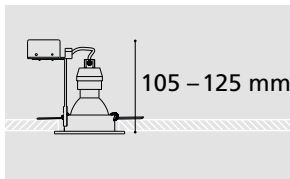

RECESSED LUMINAIRES

WITH BULBS

ADVANTAGES

- > PROVEN TECHNOLOGY, CUSTOMIZED SOLUTIONS IN EVERY PRICE CATEGORY
- > DEPENDING ON THE SELECTED LAMPS APPROPRIATE FOR ILLUMINATING AREAS AND ROOMS OR FOR ACCENT LIGHTING
- > GREAT COLORS AND SHAPES
- > UP TO 80% POWER SAVINGS COMPARED TO INCANDESCENT LAMPS, EASY ON YOUR BUDGET AND THE ENVIRONMENT
- > LAMP REPLACEABLE FROM THE BOTTOM

VORTEILE

- > BEWÄHRTE TECHNOLOGIE, INDIVIDUELLE LÖSUNGEN IN JEDER PREISKLASSE
- > JE NACH EINGESETZTEM LEUCHTMITTEL ZUR BELEUCHTUNG VON FLÄCHEN UND RÄUMEN ODER ZUR AKZENTBELEUCHTUNG
- > GROSSE FARBEN- UND FORMENVIELFALT
- > BIS ZU 80% STROMERSPARNIS GEGENÜBER GLÜHLAMPEN, SCHONT IHR BUDGET UND DIE UMWELT
- > LEUCHTMITTEL VON UNTEN TAUSCHBAR

ADVANTAGES

- > UNE TECHNOLOGIE ÉPROUVÉE, SOLUTIONS INDIVIDUELLES DANS CHAQUE CATÉGORIE DE PRIX
- > SELON LES LAMPES CHOISIES APTE À ÉCLAIRER DES SURFACES ET DES CHAMBRES OU POUR L'ÉCLAIRAGE ACCENTUEL
- > COULEURS ET FORMES FANTASTIQUES
- > JUSQU'À 80% D'ÉCONOMIES D'ÉNERGIE PAR RAPPORT AUX LAMPES À INCANDESCENCE, RÉDUIT VOTRE BUDGET ET PROTÈGE L'ENVIRONNEMENT
- > LAMPE REMPLAÇABLE PAR LE BAS

OVERVIEW

5 year warranty
Jahre Garantie
ans de garantie
anni di garanzia
años de garantía
años de garantía



SALUZZO
p. 204



SALUZZO
p. 204



AREITIO
p. 206



AREITIO
p. 206



PENETO
p. 207



PENETO
p. 207



PENETO
p. 207



PENETO
p. 208



PENETO
p. 209



PENETO
p. 209



PENETO
p. 209



TEDO
p. 210



TEDO
p. 210



TEDO
p. 210



TEDO
p. 211



TEDO 1
p. 212



TEDO 1
p. 212



TEDO 1
p. 213



99062



99061

DESIGN
HIGHLIGHT
DETAIL



99062 SALUZZO

recessed light; steel, white
Einbauleuchte; Stahl, weiss
luminaire encastrable; acier, blanc

H 3, Ø 90

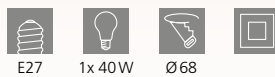

99061 SALUZZO

recessed light; steel, black
Einbauleuchte; Stahl, schwarz
luminaire encastrable; acier, noir

H 3, Ø 90

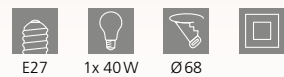

Ø 90



Ø 90



99061

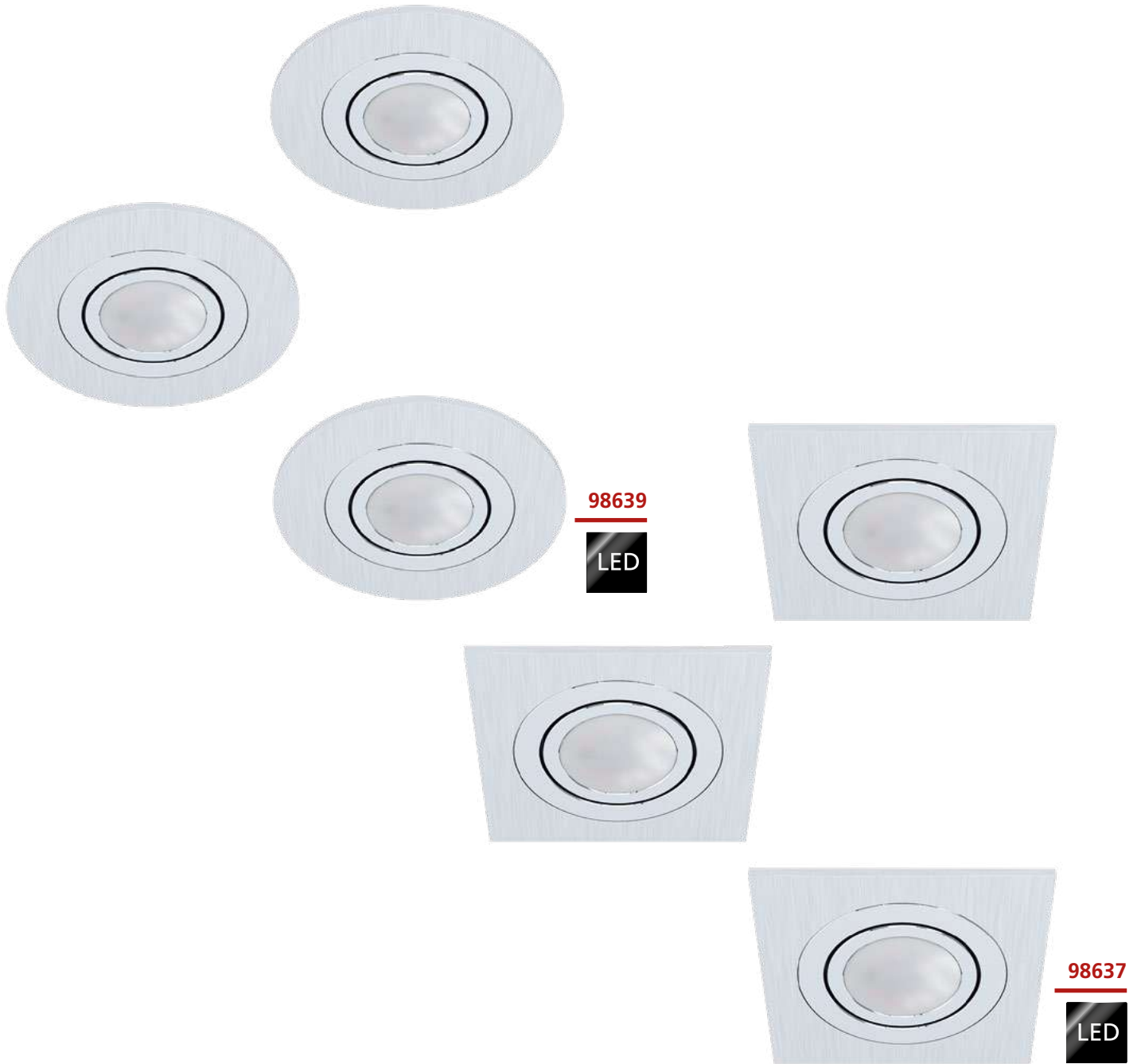

98639 AREITIO

recessed light; aluminium, brushed aluminium
 Einbauleuchte; Alu, alu-gebürstet
 luminaire encastrable; aluminium, aluminium brossé

Ø 110

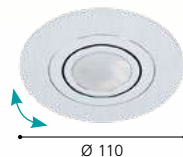

98637 AREITIO

recessed light; aluminium, brushed aluminium
 Einbauleuchte; Alu, alu-gebürstet
 luminaire encastrable; aluminium, aluminium brossé

L 95, B 95, ET 115

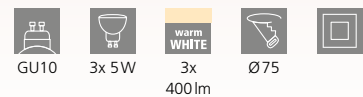



94235 PENETO

recessed light; steel, white
 Einbauleuchte; Stahl, weiss
 luminaire encastrable; acier, blanc

Ø 78, ET 115



94236 PENETO

recessed light; steel, chrome
 Einbauleuchte; Stahl, chrom
 luminaire encastrable; acier, chrome

Ø 78, ET 115



94237 PENETO

recessed light; steel, satin nickel
 Einbauleuchte; Stahl, nickel-matt
 luminaire encastrable; acier, nickel mat

Ø 78, ET 115

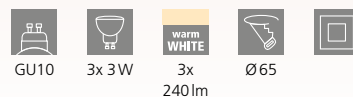



94239

LED



94239

LED

94239 PENETO

recessed light; steel, white
 Einbauleuchte; Stahl, weiss
 luminaire encastrable; acier, blanc

Ø 87, ET 115



GU10



1x 5W



warm
 WHITE
 1x
 400lm



Ø70



9 002759 942397



INCL.



RECESSED

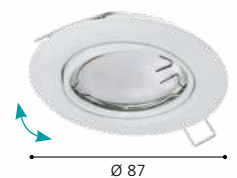

Ø 87



94406

LED



94408

LED



94407

LED

94406 PENETO

recessed light; steel, white
Einbauleuchte; Stahl, weiss
luminaire encastrable; acier, blanc

Ø 87, ET 115



94408 PENETO

recessed light; steel, satin nickel
Einbauleuchte; Stahl, nickel-matt
luminaire encastrable; acier, nickel mat

Ø 87, ET 115



94407 PENETO

recessed light; steel, chrome
Einbauleuchte; Stahl, chrom
luminaire encastrable; acier, chrome

Ø 87, ET 115



9 002759 944063



Ø 87



9 002759 944087



Ø 87



9 002759 944070



Ø 87



31682

LED



31683

LED



31689

LED

31682 TEDO

recessed light; cast aluminium, white
 Einbauleuchte; Aluguss, weiss
 luminaire encastrable; fonte d'aluminium, blanc

31683 TEDO

recessed light; cast aluminium, white
 Einbauleuchte; Aluguss, weiss
 luminaire encastrable; fonte d'aluminium, blanc

31689 TEDO

recessed light; cast aluminium, satin nickel
 Einbauleuchte; Aluguss, nickel-matt
 luminaire encastrable; fonte d'aluminium, nickel mat

Ø 80, ET 115



Ø 80, ET 115

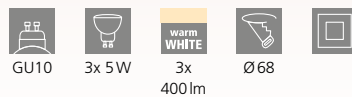

Ø 80, ET 115





31688

LED



31688

LED

31688 TEDO

recessed light; cast aluminium, satin nickel

Einbauleuchte; Aluguss, nickel-matt

luminaire encastrable; fonte d'aluminium, nickel mat

Ø 80, ET 115



GU10



1x 5W



warm
WHITE
1x
400lm



Ø 68



9 002759 316884



Ø 80



98641

LED



98641

LED

98641 TEDO 1

recessed light; cast aluminium, white
Einbauleuchte; Aluguss, weiss
luminaire encastrable; fonte d'aluminium, blanc

Ø 80, ET 115



GU10



1x 5W



warm
WHITE
1x
400lm



Ø68



95357 TEDO 1

recessed light; cast aluminium, white
Einbauleuchte; Aluguss, weiss
luminaire encastrable; fonte d'aluminium, blanc

Ø 80, ET 115



GU10



3x 5W



warm
WHITE
3x
400lm



Ø68



9 002759 986414



Ø 80



9 002759 953577



Ø 80



95357

LED



95359

LED

95359 TEDO 1

recessed light; cast aluminium, satin nickel

Einbauleuchte; Aluguss, nickel-matt

luminaire encastrable; fonte d'aluminium, nickel mat

Ø 80, ET 115



GU10



3x 5W



warm
WHITE
3x
400lm



Ø68



9 002759 953591

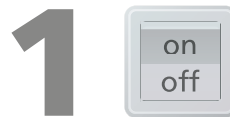

DIMMING WITHOUT A DIMMER?

There's no need for a dimmer anymore, and no need to spend money on an expensive modern LED-capable one.

The luminaire automatically switches to the next dimming level when it is switched off and on again within 3 seconds. If the luminaire stays off for more than 3 seconds, the next activation will automatically return to full lighting. You don't need to switch through all levels the next day.

Note

Our step dimming illuminants are only dimmable via the on/off switch. Operation with a conventional dimmer is not intended and may cause permanent damage to the electronics. The illuminants are therefore marked as "not dimmable" according to European regulations.

DIMMEN OHNE DIMMER?

Kein Dimmer mehr notwendig – Sie ersparen sich somit hohe Anschaffungskosten für einen modernen LED-fähigen Dimmer.

Wird die Leuchte innerhalb von 3 Sekunden aus- und wieder eingeschaltet, wechselt es automatisch in die nächste Dimmstufe. Bleibt die Leuchte länger als 3 Sekunden ausgeschaltet, stehen Ihnen beim nächsten Einschalten automatisch wieder 100 % Leuchtkraft zur Verfügung – Sie ersparen sich also das mühsame Durchschalten am nächsten Tag.

Hinweis

Unsere Stepdimming-Leuchtmittel sind nur über Ein-/Ausschalter dimmbar – der Betrieb mit konventionellen Dimmern ist nicht vorgesehen und könnte die Elektronik dauerhaft beschädigen. Die Leuchtmittel werden daher gemäß europäischer Vorschriften als „nicht dimmbar“ gekennzeichnet.

GRADUER SANS GRADUATEUR ?

Aucun graduateur n'est nécessaire – Vous vous épargnez ainsi les coûts d'acquisition élevés pour un graduateur DEL moderne.

Lorsque le luminaire est éteint, puis rallumé en l'espace de 3 secondes, il passe automatiquement au prochain niveau de graduation. Lorsque le luminaire reste éteint plus de 3 secondes, vous aurez à nouveau automatiquement 100 % de la force lumineuse lors du prochain allumage – Vous vous épargnez alors la commutation fatigante le lendemain.

Remarque

Nos ampoules à graduation par niveau sont graduable uniquement par l'interrupteur marche / arrêt – le service avec un graduateur conventionnel n'est pas prévu et pourrait endommager l'électronique à long terme. Les ampoules sont alors marquées par « non graduable », selon les réglementations européenne.

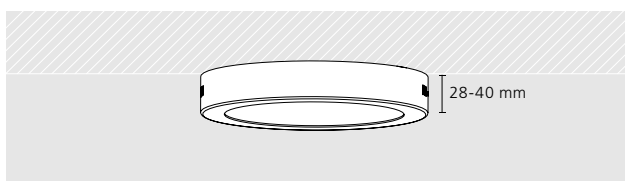

SURFACE LUMINAIRES

FUEVA

ADVANTAGES

- > SLIM DESIGN WITH LOW SURFACE HEIGHT (28 TO 40 MM)
- > UNIFORM DISTRIBUTION OF INDIRECT LIGHT - IDEAL FOR ILLUMINATING SPACES AND SURFACES
- > LOW TEMPERATURE ENHANCES SAFETY
- > UP TO 80% POWER SAVINGS COMPARED TO INCANDESCENT LAMPS, EASY ON YOUR BUDGET AND THE ENVIRONMENT

VORTEILE

















- > SCHLANKE BAUFORM MIT GERINGER AUFBAUHÖHE (28 BIS 40 MM)
- > HOMOGENES, INDIREKTES LICHT - IDEAL ZUR BELEUCHTUNG VON RÄUMEN UND FLÄCHEN
- > GERINGE WÄRMEENTWICKLUNG SORGT FÜR MEHR SICHERHEIT
- > BIS ZU 80% STROMERSPARNIS GEGENÜBER GLÜHLAMPEN, SCHONT IHR BUDGET UND DIE UMWELT

ADVANTAGES

- > CONCEPTION MINCE AVEC LA HAUTEUR DE SAILIE MINIMALE (DE 28 À 40 MM)
- > LA DISTRIBUTION UNIFORME DE LA LUMIÈRE INDIRECTE - IDÉAL POUR LES ESPACES ET LES SURFACES ÉCLAIRANTES
- > FAIBLE CHALEUR AMÉLIORE LA SÉCURITÉ
- > JUSQU'À 80% D'ÉCONOMIES D'ÉNERGIE PAR RAPPORT AUX LAMPES À INCANDESCENCE, RÉDUIT VOTRE BUDGET ET PROTÈGE L'ENVIRONNEMENT

OVERVIEW

5 year warranty
 Jahre Garantie
 ans de garantie
 anni di garanzia
 años de garantía

							
FUEVA 5 p. 217	FUEVA 5 p. 217	FUEVA 5 p. 217	FUEVA 5 p. 218	FUEVA 5 p. 218	FUEVA 5 p. 218	FUEVA 5 p. 219	FUEVA 5 p. 219
							
FUEVA 5 p. 219	FUEVA 5 p. 220	FUEVA 5 p. 220	FUEVA 5 p. 220	FUEVA 5 p. 221	FUEVA 5 p. 221	FUEVA 5 p. 221	FUEVA 5 p. 222
							
FUEVA 5 p. 222	FUEVA 5 p. 222	FUEVA 5 p. 224	FUEVA 5 p. 224	FUEVA 5 p. 224	FUEVA 5 p. 225	FUEVA 5 p. 225	FUEVA 5 p. 225
							
FUEVA 5 p. 226	FUEVA 5 p. 226	FUEVA 5 p. 226	FUEVA 5 p. 228	FUEVA 5 p. 228	FUEVA 5 p. 228	FUEVA 5 p. 229	FUEVA 5 p. 229
							
FUEVA 5 p. 229	FUEVA 5 p. 230	FUEVA 5 p. 230	FUEVA 5 p. 230	FUEVA 5 p. 232	FUEVA 5 p. 232	FUEVA 5 p. 232	FUEVA 5 p. 233
							
FUEVA 5 p. 234	FUEVA 5 p. 234	FUEVA 5 p. 234	FUEVA 5 p. 236	FUEVA 5 p. 236	FUEVA 5 p. 236	FUEVA 5 p. 238	FUEVA 5 p. 239
							
FUEVA 5 p. 239	FUEVA 5 p. 239	FUEVA 1 p. 240	FUEVA 1 p. 240	FUEVA 1 p. 240	FUEVA 1 p. 241	FUEVA 1 p. 241	FUEVA 1 p. 241
							
FUEVA 1 p. 242	FUEVA 1 p. 242	FUEVA 1 p. 242	FUEVA 1 p. 243				

FUEVA 5

FEATURES

Quick Connector
Schnellverbinder
Connecteur rapide

FLICKER FREE
FLICKER FREI
FLICKER FREE



DESIGN

Flat design from originally 40 mm
high to **28** mm high
Flaches Design von ursprünglich 40 mm
Höhe auf **28** mm Höhe
Design plat de 40 mm de haut à
28 mm de haut

Narrow frame from 21 mm to **15** mm
Schmäler Rahmen von 21 mm auf **15** mm
Cadre étroit de 21 mm vers **15** mm

Modern appearance
Modernerer Erscheinungsbild
Apparence plus moderne



99215



99217



99216



99215 FUEVA 5

surface-mounted light; steel, white / plastic, white
Aufbauleuchte; Stahl, weiss / Kunststoff, weiss
luminaire en saillie; acier, blanc / plastique, blanc

H 28, Ø 160



10,5W 1200lm

99216 FUEVA 5

surface-mounted light; steel, white / plastic, white
Aufbauleuchte; Stahl, weiss / Kunststoff, weiss
luminaire en saillie; acier, blanc / plastique, blanc

H 28, Ø 210



16,5W 1800lm

99217 FUEVA 5

surface-mounted light; steel, white / plastic, white
Aufbauleuchte; Stahl, weiss / Kunststoff, weiss
luminaire en saillie; acier, blanc / plastique, blanc

H 28, Ø 285



20W 2300lm



9 002759 992156



Ø 160



9 002759 992163



Ø 210



9 002759 992170



Ø 285



99218



99221



99219



99218 FUEVA 5

surface-mounted light; steel, satin nickel / plastic, white
Aufbauleuchte; Stahl, nickel-matt / Kunststoff, weiss
luminaire en saillie; acier, nickel mat / plastique, blanc

H 28, Ø 160



10,5W 1200lm

99219 FUEVA 5

surface-mounted light; steel, satin nickel / plastic, white
Aufbauleuchte; Stahl, nickel-matt / Kunststoff, weiss
luminaire en saillie; acier, nickel mat / plastique, blanc

H 28, Ø 210



16,5W 1800lm

99221 FUEVA 5

surface-mounted light; steel, satin nickel / plastic, white
Aufbauleuchte; Stahl, nickel-matt / Kunststoff, weiss
luminaire en saillie; acier, nickel mat / plastique, blanc

H 28, Ø 285



20W 2300lm



9 002759 992187



Ø 160



9 002759 992194



Ø 210



9 002759 992217



Ø 285



99222



99224



99223



99222 FUEVA 5

surface-mounted light; steel, black / plastic, white
Aufbauleuchte; Stahl, schwarz / Kunststoff, weiss
luminaire en saillie; acier, noir / plastique, blanc

H 28, Ø 160



10,5W 1200lm

99223 FUEVA 5

surface-mounted light; steel, black / plastic, white
Aufbauleuchte; Stahl, schwarz / Kunststoff, weiss
luminaire en saillie; acier, noir / plastique, blanc

H 28, Ø 210



16,5W 1800lm

99224 FUEVA 5

surface-mounted light; steel, black / plastic, white
Aufbauleuchte; Stahl, schwarz / Kunststoff, weiss
luminaire en saillie; acier, noir / plastique, blanc

H 28, Ø 285



20W 2300lm



9 002759 992224



Ø 160



9 002759 992231



Ø 210



9 002759 992248



Ø 285



99225



99227



99226



99225 FUEVA 5

surface-mounted light; steel, white / plastic, white
Aufbauleuchte; Stahl, weiss / Kunststoff, weiss
luminaire en saillie; acier, blanc / plastique, blanc

H 28, Ø 160



10,5W 1350lm

99226 FUEVA 5

surface-mounted light; steel, white / plastic, white
Aufbauleuchte; Stahl, weiss / Kunststoff, weiss
luminaire en saillie; acier, blanc / plastique, blanc

H 28, Ø 210



16,5W 2000lm

99227 FUEVA 5

surface-mounted light; steel, white / plastic, white
Aufbauleuchte; Stahl, weiss / Kunststoff, weiss
luminaire en saillie; acier, blanc / plastique, blanc

H 28, Ø 285



20W 2500lm



9 002759 992255



Ø 160



9 002759 992262



Ø 210



9 002759 992279



Ø 285





99228



99232



99229



99228 FUEVA 5

surface-mounted light; steel, satin nickel / plastic, white
Aufbauleuchte; Stahl, nickel-matt / Kunststoff, weiss
luminaire en saillie; acier, nickel mat / plastique, blanc

H 28, Ø 160



10,5W 1350lm

99229 FUEVA 5

surface-mounted light; steel, satin nickel / plastic, white
Aufbauleuchte; Stahl, nickel-matt / Kunststoff, weiss
luminaire en saillie; acier, nickel mat / plastique, blanc

H 28, Ø 210



16,5W 2000lm

99232 FUEVA 5

surface-mounted light; steel, satin nickel / plastic, white
Aufbauleuchte; Stahl, nickel-matt / Kunststoff, weiss
luminaire en saillie; acier, nickel mat / plastique, blanc

H 28, Ø 285



20W 2500lm



9 002759 992286



Ø 160



9 002759 992293



Ø 210



9 002759 992323



Ø 285



99233



99235



99234



99233 FUEVA 5

surface-mounted light; steel, black / plastic, white
Aufbauleuchte; Stahl, schwarz / Kunststoff, weiss
luminaire en saillie; acier, noir / plastique, blanc

H 28, Ø 160



10,5W 1350lm

99234 FUEVA 5

surface-mounted light; steel, black / plastic, white
Aufbauleuchte; Stahl, schwarz / Kunststoff, weiss
luminaire en saillie; acier, noir / plastique, blanc

H 28, Ø 210



16,5W 2000lm

99235 FUEVA 5

surface-mounted light; steel, black / plastic, white
Aufbauleuchte; Stahl, schwarz / Kunststoff, weiss
luminaire en saillie; acier, noir / plastique, blanc

H 28, Ø 285



20W 2500lm



9 002759 992330



Ø 160



9 002759 992347



Ø 210



9 002759 992354



Ø 285



99235





99236

LED



99238

LED



99237

LED

99236 FUEVA 5

surface-mounted light; steel, white / plastic, white
Aufbauleuchte; Stahl, weiss / Kunststoff, weiss
luminaire en saillie; acier, blanc / plastique, blanc

L 160, B 160, H 28



10,5W 1200lm

99237 FUEVA 5

surface-mounted light; steel, white / plastic, white
Aufbauleuchte; Stahl, weiss / Kunststoff, weiss
luminaire en saillie; acier, blanc / plastique, blanc

L 210, B 210, H 28



16,5W 1800lm

99238 FUEVA 5

surface-mounted light; steel, white / plastic, white
Aufbauleuchte; Stahl, weiss / Kunststoff, weiss
luminaire en saillie; acier, blanc / plastique, blanc

L 285, B 285, H 28



20W 2300lm



9 002759 992361



L 160

B 160



9 002759 992378



L 210

B 210



9 002759 992385



L 285

B 285



99239



99242



99241



99239 FUEVA 5

surface-mounted light; steel, satin nickel / plastic, white
Aufbauleuchte; Stahl, nickel-matt / Kunststoff, weiss
luminaire en saillie; acier, nickel mat / plastique, blanc

L 160, B 160, H 28



10,5W 1200lm

99241 FUEVA 5

surface-mounted light; steel, satin nickel / plastic, white
Aufbauleuchte; Stahl, nickel-matt / Kunststoff, weiss
luminaire en saillie; acier, nickel mat / plastique, blanc

L 210, B 210, H 28



16,5W 1800lm

99242 FUEVA 5

surface-mounted light; steel, satin nickel / plastic, white
Aufbauleuchte; Stahl, nickel-matt / Kunststoff, weiss
luminaire en saillie; acier, nickel mat / plastique, blanc

L 285, B 285, H 28



20W 2300lm



9 002759 992392



L 160



9 002759 992415



L 210



9 002759 992422



L 285



99243



99245



99244



99243 FUEVA 5

surface-mounted light; steel, black / plastic, white
 Aufbauleuchte; Stahl, schwarz / Kunststoff, weiss
 luminaire en saillie; acier, noir / plastique, blanc

L 160, B 160, H 28



10,5W 1200lm

99244 FUEVA 5

surface-mounted light; steel, black / plastic, white
 Aufbauleuchte; Stahl, schwarz / Kunststoff, weiss
 luminaire en saillie; acier, noir / plastique, blanc

L 210, B 210, H 28



16,5W 1800lm

99245 FUEVA 5

surface-mounted light; steel, black / plastic, white
 Aufbauleuchte; Stahl, schwarz / Kunststoff, weiss
 luminaire en saillie; acier, noir / plastique, blanc

L 285, B 285, H 28



20W 2300lm



9 002759 992439



L 160



9 002759 992446



L 210



9 002759 992453



L 285

B 285



99245

LED





99246



99248



99247



99246 FUEVA 5

surface-mounted light; steel, white / plastic, white
Aufbauleuchte; Stahl, weiss / Kunststoff, weiss
luminaire en saillie; acier, blanc / plastique, blanc

L 160, B 160, H 28



10,5W 1350lm

99247 FUEVA 5

surface-mounted light; steel, white / plastic, white
Aufbauleuchte; Stahl, weiss / Kunststoff, weiss
luminaire en saillie; acier, blanc / plastique, blanc

L 210, B 210, H 28



16,5W 2000lm

99248 FUEVA 5

surface-mounted light; steel, white / plastic, white
Aufbauleuchte; Stahl, weiss / Kunststoff, weiss
luminaire en saillie; acier, blanc / plastique, blanc

L 285, B 285, H 28



20W 2500lm



9 002759 992460

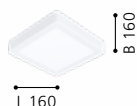

9 002759 992477



9 002759 992484





99252



99254



99253



99252 FUEVA 5

surface-mounted light; steel, satin nickel / plastic, white
Aufbauleuchte; Stahl, nickel-matt / Kunststoff, weiss
luminaire en saillie; acier, nickel mat / plastique, blanc

L 160, B 160, H 28



10,5W 1350lm

99253 FUEVA 5

surface-mounted light; steel, satin nickel / plastic, white
Aufbauleuchte; Stahl, nickel-matt / Kunststoff, weiss
luminaire en saillie; acier, nickel mat / plastique, blanc

L 210, B 210, H 28



16,5W 2000lm

99254 FUEVA 5

surface-mounted light; steel, satin nickel / plastic, white
Aufbauleuchte; Stahl, nickel-matt / Kunststoff, weiss
luminaire en saillie; acier, nickel mat / plastique, blanc

L 285, B 285, H 28



20W 2500lm



9 002759 992521



9 002759 992538



9 002759 992545





99255



99257



99256



99255 FUEVA 5

surface-mounted light; steel, black / plastic, white
Aufbauleuchte; Stahl, schwarz / Kunststoff, weiss
luminaire en saillie; acier, noir / plastique, blanc

L 160, B 160, H 28



10,5W 1350lm

99256 FUEVA 5

surface-mounted light; steel, black / plastic, white
Aufbauleuchte; Stahl, schwarz / Kunststoff, weiss
luminaire en saillie; acier, noir / plastique, blanc

L 210, B 210, H 28



16,5W 2000lm

99257 FUEVA 5

surface-mounted light; steel, black / plastic, white
Aufbauleuchte; Stahl, schwarz / Kunststoff, weiss
luminaire en saillie; acier, noir / plastique, blanc

L 285, B 285, H 28



20W 2500lm



9 002759 992552



9 002759 992569

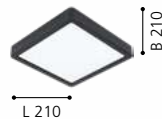

9 002759 992576





99256

LED



99258



99263



99259



99258 FUEVA 5

surface-mounted light; steel, white / plastic, white
Aufbauleuchte; Stahl, weiss / Kunststoff, weiss
luminaire en saillie; acier, blanc / plastique, blanc

H 28, Ø 210



16,5W 1800lm

99259 FUEVA 5

surface-mounted light; steel, white / plastic, white
Aufbauleuchte; Stahl, weiss / Kunststoff, weiss
luminaire en saillie; acier, blanc / plastique, blanc

H 28, Ø 285

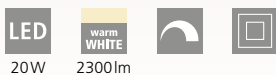

20W 2300lm

99263 FUEVA 5

surface-mounted light; steel, black / plastic, white
Aufbauleuchte; Stahl, schwarz / Kunststoff, weiss
luminaire en saillie; acier, noir / plastique, blanc

H 28, Ø 210



16,5W 1800lm



9 002759 992583



Ø 210



9 002759 992590



Ø 285



9 002759 992637



Ø 210



99264



99263



99264 FUEVA 5

surface-mounted light; steel, black / plastic, white
Aufbauleuchte; Stahl, schwarz / Kunststoff, weiss
luminaire en saillie; acier, noir / plastique, blanc

H 28, Ø 285

LED

20W

warm
WHITE

2300lm



9 002759 992644



Ø 285



99265



IP44



99267



IP44

99265 FUEVA 5

surface-mounted light; steel, white / plastic, white
 Aufbauleuchte; Stahl, weiss / Kunststoff, weiss
 luminaire en saillie; acier, blanc / plastique, blanc

H 28, Ø 285



99267 FUEVA 5

surface-mounted light; steel, black / plastic, white
 Aufbauleuchte; Stahl, schwarz / Kunststoff, weiss
 luminaire en saillie; acier, noir / plastique, blanc

H 28, Ø 285



99266 FUEVA 5

surface-mounted light; steel, chrome / plastic, white
 Aufbauleuchte; Stahl, chrom / Kunststoff, weiss
 luminaire en saillie; acier, chrome / plastique, blanc

H 28, Ø 285



9 002759 992651



Ø 285



9 002759 992675



Ø 285



9 002759 992668



Ø 285





99266



IP44



99266



IP44



99268



IP44



99271



IP44

99268 FUEVA 5

surface-mounted light; steel, white / plastic, white
 Aufbauleuchte; Stahl, weiss / Kunststoff, weiss
 luminaire en saillie; acier, blanc / plastique, blanc

L 285, B 285, H 30



20W 2300lm



9 002759 992682



L 285

99271 FUEVA 5

surface-mounted light; steel, black / plastic, white
 Aufbauleuchte; Stahl, schwarz / Kunststoff, weiss
 luminaire en saillie; acier, noir / plastique, blanc

L 285, B 285, H 30



20W 2300lm



9 002759 992712



L 285

99269 FUEVA 5

surface-mounted light; steel, chrome / plastic, white
 Aufbauleuchte; Stahl, chrom / Kunststoff, weiss
 luminaire en saillie; acier, chrome / plastique, blanc

L 285, B 285, H 30



20W 2300lm



9 002759 992699



L 285



99269



IP44



99269



IP44



30892

LED



IP44



30892

LED



IP44



30891

LED



IP44

30892 FUEVA 5

surface-mounted light; steel, chrome / plastic, white
Aufbauleuchte; Stahl, chrom / Kunststoff, weiss
luminaire en saillie; acier, chrome / plastique, blanc

H 28, Ø 285

LED

20W

neutral
WHITE

2200lm



IP44



9 002759 308926



SURFACE



Ø 285

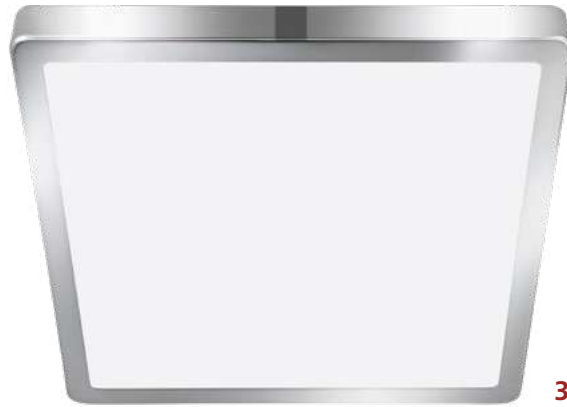

30894



IP44



30893



IP44

30891 FUEVA 5

surface-mounted light; steel, white / plastic, white
 Aufbauleuchte; Stahl, weiss / Kunststoff, weiss
 luminaire en saillie; acier, blanc / plastique, blanc

H 28, Ø 285



20W



2200lm



IP44



9 002759 308919



Ø 285



30894 FUEVA 5

surface-mounted light; steel, chrome / plastic, white
 Aufbauleuchte; Stahl, chrom / Kunststoff, weiss
 luminaire en saillie; acier, chrome / plastique, blanc

L 285, B 285, H 30



20W



2200lm



IP44



9 002759 308940



L 285

B 285



30893 FUEVA 5

surface-mounted light; steel, white / plastic, white
 Aufbauleuchte; Stahl, weiss / Kunststoff, weiss
 luminaire en saillie; acier, blanc / plastique, blanc

L 285, B 285, H 30



20W



2200lm



IP44



9 002759 308933



L 285

B 285





97262

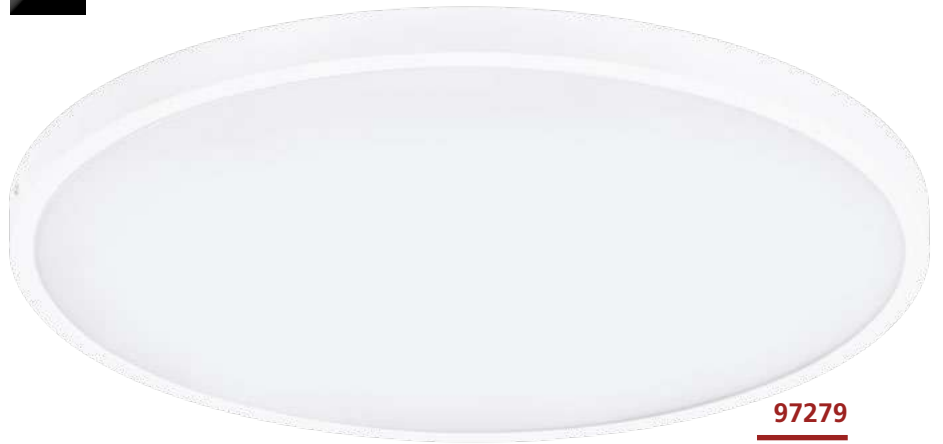

97279



97271



97262 FUEVA 1

surface-mounted light; aluminium, white / plastic, white
Aufbauleuchte; Alu, weiss / Kunststoff, weiss
luminaire en saillie; aluminium, blanc / plastique, blanc

H 30, Ø 400



97271 FUEVA 1

surface-mounted light; aluminium, white / plastic, white
Aufbauleuchte; Alu, weiss / Kunststoff, weiss
luminaire en saillie; aluminium, blanc / plastique, blanc

H 30, Ø 500



97279 FUEVA 1

surface-mounted light; aluminium, white / plastic, white
Aufbauleuchte; Alu, weiss / Kunststoff, weiss
luminaire en saillie; aluminium, blanc / plastique, blanc

H 30, Ø 600



9 002759 972622



Ø 400



9 002759 972714



Ø 500



9 002759 972790



Ø 600



97263



97266



97267



97266 FUEVA 1

surface-mounted light; aluminium, white / plastic, white
Aufbauleuchte; Alu, weiss / Kunststoff, weiss
luminaire en saillie; aluminium, blanc / plastique, blanc

H 30, Ø 400



97263 FUEVA 1

surface-mounted light; aluminium, silver / plastic, white
Aufbauleuchte; Alu, silber / Kunststoff, weiss
luminaire en saillie; aluminium, argent / plastique, blanc

H 30, Ø 400



97267 FUEVA 1

surface-mounted light; aluminium, silver / plastic, white
Aufbauleuchte; Alu, silber / Kunststoff, weiss
luminaire en saillie; aluminium, argent / plastique, blanc

H 30, Ø 400

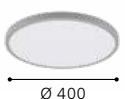



97269

LED



97265

LED

97265 FUEVA 1

surface-mounted light; aluminium, silver / plastic, white
 Aufbauleuchte; Alu, silber / Kunststoff, weiss
 luminaire en saillie; aluminium, argent / plastique, blanc

L 400, B 400, H 30



97269 FUEVA 1

surface-mounted light; aluminium, silver / plastic, white
 Aufbauleuchte; Alu, silber / Kunststoff, weiss
 luminaire en saillie; aluminium, argent / plastique, blanc

L 400, B 400, H 30



97264 FUEVA 1

surface-mounted light; aluminium, white / plastic, white
 Aufbauleuchte; Alu, weiss / Kunststoff, weiss
 luminaire en saillie; aluminium, blanc / plastique, blanc

L 400, B 400, H 30

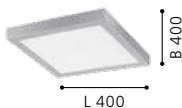



97268



97264



97268



97268 FUEVA 1

surface-mounted light; aluminium, white / plastic, white
Aufbauleuchte; Alu, weiss / Kunststoff, weiss
luminaire en saillie; aluminium, blanc / plastique, blanc

L 400, B 400, H 30



25W



2500lm



9 002759 972684

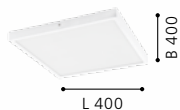



SURFACE LUMINAIRES

DECORATIVE

ADVANTAGES

- > UNIFORM DISTRIBUTION OF INDIRECT LIGHT - IDEAL FOR ILLUMINATING SPACES AND SURFACES
 - > LOW TEMPERATURE ENHANCES SAFETY
 - > UP TO 80% POWER SAVINGS COMPARED TO INCANDESCENT LAMPS, EASY ON YOUR BUDGET AND THE ENVIRONMENT
-

VORTEILE

- > HOMOGENES, INDIREKTES LICHT – IDEAL ZUR BELEUCHTUNG VON RÄUMEN UND FLÄCHEN
 - > GERINGE WÄRMEENTWICKLUNG SORGT FÜR MEHR SICHERHEIT
 - > BIS ZU 80% STROMERSPARNIS GEGENÜBER GLÜHLAMPEN, SCHONT IHR BUDGET UND DIE UMWELT
-

ADVANTAGES

- > LA DISTRIBUTION UNIFORME DE LA LUMIÈRE INDIRECTE - IDÉAL POUR LES ESPACES ET LES SURFACES ÉCLAIRANTES
- > FAIBLE CHALEUR AMÉLIORE LA SÉCURITÉ
- > JUSQU'À 80% D'ÉCONOMIES D'ÉNERGIE PAR RAPPORT AUX LAMPES À INCANDESCENCE, RÉDUIT VOTRE BUDGET ET PROTÈGE L'ENVIRONNEMENT

OVERVIEW

5 year warranty
Jahre Garantie
ans de garantie
anni di garanzia
años de garantía
años de garantía



CRESPILLO
p. 246



CRESPILLO
p. 246



CRESPILLO
p. 246



CRESPILLO
p. 247



POLASSO
p. 248



POLASSO
p. 248



POLASSO
p. 248



POLASSO
p. 249



POLASSO
p. 250



POLASSO
p. 250



POLASSO
p. 250



FERREROS
p. 252



FERREROS
p. 252



FERREROS
p. 252



LOKE 1
p. 253



SALUZZO
p. 254



SALUZZO
p. 254



GRIMASOLA
p. 256



GRIMASOLA
p. 256



GRIMASOLA
p. 256



GRIMASOLA
p. 257





DESIGN
HIGHLIGHT
DETAIL



99338

LED



99337

LED



99726

LED

99337 CRESPILLO

surface-mounted light; plastic, steel, white / plastic, white
Aufbauleuchte; Kunststoff, Stahl, weiss / Kunststoff, weiss
luminaire en saillie; plastique, acier, blanc / plastique, blanc

H 45, Ø 240



16W 1600lm

99338 CRESPILLO

surface-mounted light; plastic, steel, white / plastic, white
Aufbauleuchte; Kunststoff, Stahl, weiss / Kunststoff, weiss
luminaire en saillie; plastique, acier, blanc / plastique, blanc

H 45, Ø 315



18W 2000lm

99726 CRESPILLO

surface-mounted light; plastic, white / plastic, white
Aufbauleuchte; Kunststoff, weiss / Kunststoff, weiss
luminaire en saillie; plastique, blanc / plastique, blanc

H 65, Ø 380



21,6W 2400lm



9 002759 993375



Ø 240



9 002759 993382



Ø 315



9 002759 997267



Ø 380



99727

LED



99338

LED

99727 CRESPILO

surface-mounted light; plastic, white / plastic, white
Aufbauleuchte; Kunststoff, weiss / Kunststoff, weiss
luminaire en saillie; plastique, blanc / plastique, blanc

H 65, Ø 500

LED

32,4W

neutral
WHITE

3600lm



9 002759 997274



Ø 500





94501

LED



94502

LED



94504

LED

94501 POLASSO

ceiling light; aluminium, plastic, black, copper
Deckenleuchte; Alu, Kunststoff, schwarz, kupfer
plafonnier; aluminium, plastique, noir, cuivre

H 120, Ø 100



1x 3,3W
1x 340lm



9 002759 945015



94504 POLASSO

ceiling light; aluminium, plastic, white, silver
Deckenleuchte; Alu, Kunststoff, weiss, silber
plafonnier; aluminium, plastique, blanc, argent

H 120, Ø 100



1x 3,3W
1x 340lm



9 002759 945046



94502 POLASSO

ceiling light; aluminium, plastic, black, gold
Deckenleuchte; Alu, Kunststoff, schwarz, gold
plafonnier; aluminium, plastique, noir, or

H 120, Ø 100



1x 3,3W
1x 340lm



9 002759 945022





94503

LED



94501

LED

94503 POLASSO

ceiling light; aluminium, plastic, white, gold
Deckenleuchte; Alu, Kunststoff, weiss, gold
plafonnier; aluminium, plastique, blanc, or

H 120, Ø 100

LED

warm
WHITE



1x 3,3W

1x
340lm



9 002759 945039



H 120

Ø 100





94496

LED



94499

LED



94497

LED

94496 POLASSO

ceiling light; aluminium, plastic, black, copper
Deckenleuchte; Alu, Kunststoff, schwarz, kupfer
plafonnier; aluminium, plastique, noir, cuivre

L 100, B 100, H 120



1x 3,3W
1x 340lm



9 002759 944964

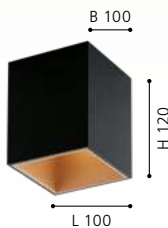

94497 POLASSO

ceiling light; aluminium, plastic, black, gold
Deckenleuchte; Alu, Kunststoff, schwarz, gold
plafonnier; aluminium, plastique, noir, or

L 100, B 100, H 120



1x 3,3W
1x 340lm



9 002759 944971

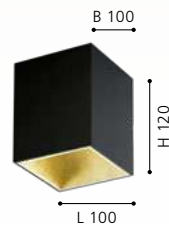

94499 POLASSO

ceiling light; aluminium, plastic, white, silver
Deckenleuchte; Alu, Kunststoff, weiss, silber
plafonnier; aluminium, plastique, blanc, argent

L 100, B 100, H 120



1x 3,3W
1x 340lm



9 002759 944995

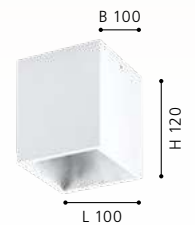



94497

LED





FERREROS

These luminaires have a special leveling effect.

Diese Leuchten besitzen einen besonderen Stufeneffekt.

Ces luminaires ont un effet escalier spécial.



96791

LED

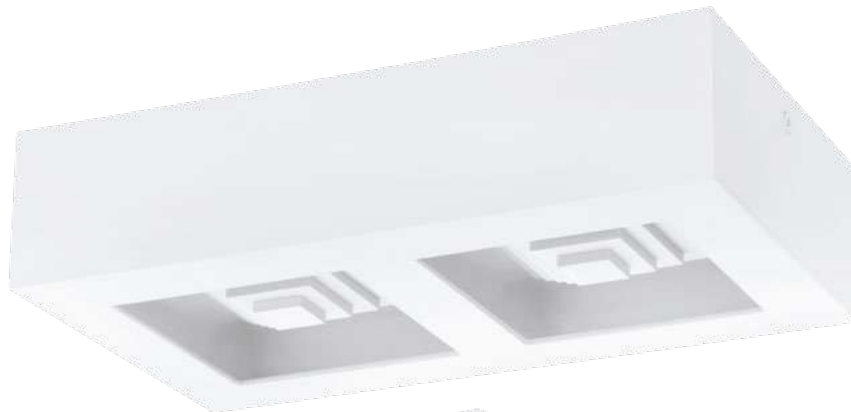

96792

LED

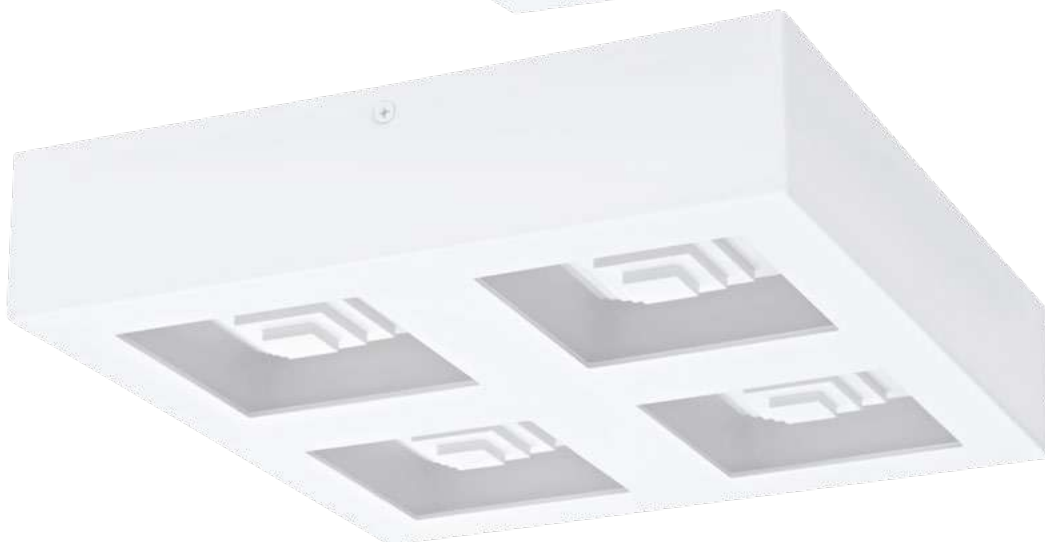

96794

LED

96791 FERREROS

wall / ceiling light; steel, white / plastic, white
Wand- / Deckenleuchte; Stahl, weiss / Kunststoff, weiss
applique / plafonnier; acier, blanc / plastique, blanc

L 140, B 140, H 60



1x 6,3W
1x 840lm



9 002759 967918

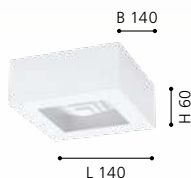

96792 FERREROS

wall / ceiling light; steel, white / plastic, white
Wand- / Deckenleuchte; Stahl, weiss / Kunststoff, weiss
applique / plafonnier; acier, blanc / plastique, blanc

L 255, B 140, H 60



2x 6,3W
2x 840lm



9 002759 967925

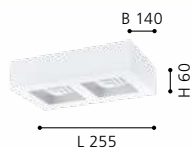

96794 FERREROS

wall / ceiling light; steel, white / plastic, white
Wand- / Deckenleuchte; Stahl, weiss / Kunststoff, weiss
applique / plafonnier; acier, blanc / plastique, blanc

L 270, B 270, H 60



4x 6,3W
4x 840lm



9 002759 967949





91355

LED



91355

LED

91355 LOKE 1

surface-mounted light; aluminium, steel, brushed aluminium, chrome, black

Aufbauleuchte; Alu, Stahl, alu-gebürstet, chrom, schwarz

luminaire en saillie; aluminium, acier, aluminium brossé, chrome, noir

L 250, B 250, A 85



GU10



4x 5W



warm
WHITE
4x
400lm



9 002759 913557





DESIGN
HIGHLIGHT
DETAIL



99066



99065

99066 SALUZZO

surface-mounted light; steel, white
Aufbauleuchte; Stahl, weiss
luminaire en saillie; acier, blanc

H 110, Ø 65



E27 1x 40W



9 002759 990664



99065 SALUZZO

surface-mounted light; steel, black
Aufbauleuchte; Stahl, schwarz
luminaire en saillie; acier, noir

H 110, Ø 65



E27 1x 40W



9 002759 990657





99065





99281



99283

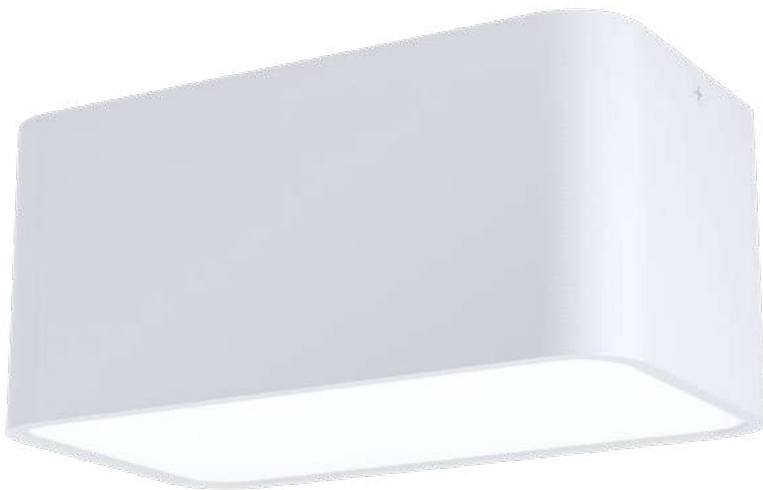

99282

99281 GRIMASOLA

surface-mounted light; aluminium, steel, white / plastic, white
Aufbauleuchte; Alu, Stahl, weiss / Kunststoff, weiss
luminaire en saillie; aluminium, acier, blanc / plastique, blanc

L 140, B 140, H 110



E27



1x 25W

99282 GRIMASOLA

surface-mounted light; aluminium, steel, white / plastic, white
Aufbauleuchte; Alu, Stahl, weiss / Kunststoff, weiss
luminaire en saillie; aluminium, acier, blanc / plastique, blanc

L 240, B 140, H 110



E27



2x 25W

99283 GRIMASOLA

surface-mounted light; aluminium, steel, black / plastic, white
Aufbauleuchte; Alu, Stahl, schwarz / Kunststoff, weiss
luminaire en saillie; aluminium, acier, noir / plastique, blanc

L 140, B 140, H 110



E27



1x 25W



9 002759 992811

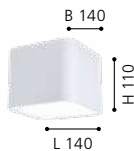

9 002759 992828

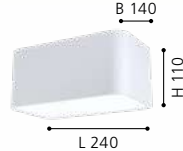

9 002759 992835

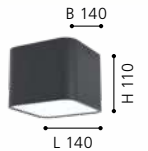



99284



99283

99284 GRIMASOLA

surface-mounted light; aluminium, steel, black / plastic, white
Aufbauleuchte; Alu, Stahl, schwarz / Kunststoff, weiss
luminaire en saillie; aluminium, acier, noir / plastique, blanc

L 240, B 140, H 110



E27



2x 25 W

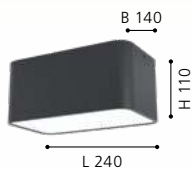



LED STRIPES

FLAIR FOR YOUR HOME -

LED STRIPS ARE AVAILABLE IN VARIOUS LENGTHS AND FOR NUMEROUS FIELDS OF APPLICATIONS. CHOOSE YOUR LIGHTING PROGRAMME AND COLOUR IN LINE WITH WHAT SUITS YOUR HOME AND YOUR MOOD. THANKS TO THE ADHESIVE TAPE ON THE BACK OF THE STRIPES, YOU CAN MOUNT THEM ANYWHERE IN NO TIME, USING THEM AS UNDER CABINET LIGHTING IN YOUR KITCHEN OR IN THE LIVING ROOM AREA.

LET YOURSELF BE INSPIRED BY EGLO LED STRIPES!

FLAIR IN IHREM ZUHAUSE -

LED STRIPS IN VERSCHIEDENEN LÄNGEN UND FÜR VIELE EINSATZBEREICHE WERDEN EINFACH MIT EINEM KLEBEBAND BEFESTIGT. JE NACH STIMMUNG KÖNNEN SIE DAS ENTSPRECHENDE LICHTPROGRAMM BZW. DIE GEEIGNETE FARBE AUSWÄHLEN – VON DER INDIRECTEN BELEUCHTUNG IN DER KÜCHENVITRINE BIS HIN ZUM WOHNZIMMER.

LASSEN SIE SICH VON DEN EGLO LED STRIPES INSPIRIEREN!

CRÉER DES AMBIANCES PERSONNALISÉES -

LES LED STRIPS SONT DISPONIBLES EN DIFFÉRENTES TAILLES ET PEUVENT ÊTRE UTILISÉS POUR DE NOMBREUSES APPLICATIONS DIFFÉRENTES. IL EXISTE DES BANDEAUX DE LED ADAPTÉS À CHAQUE PIÈCE. VOUS POURREZ CHOISIR LE PROGRAMME LUMINEUX ET LA COULEUR QUI CORRESPOND LE MIEUX À VOTRE INTÉRIEUR ET VOTRE HUMEUR.

LAISSÉZ-VOUS INSPIRER PAR LES LED STRIPES EGLO !





FLEXIBLE STRIPES

98571



98572



99716



ADVANTAGES

- > FREELY FORMABLE
- > SELF-ADHESIVE
- > SEPARABLE EVERY 10 CM
- > OPTIMAL ILLUMINATION EVEN IN CORNERS
- > NO SOLDERING OR INTERMEDIATE PIECE NECESSARY

VORTEILE

- > FREI FORMBAR
- > SELBSTKLEBEND
- > ALLE 10 CM KÜRZBAR
- > OPTIMALE AUSLEUCHTUNG AUCH IN ECKEN
- > KEIN LÖTEN ODER ZWISCHENSTÜCK NOTWENDIG

ADVANTAGES

- > SE DÉFORME AISÉMENT
- > AUTO-ADHÉSIF
- > PEUT ÊTRE SECTIONNÉ TOUS LES 10 CM
- > UN ÉCLAIRAGE OPTIMAL, MÊME DANS LES COINS
- > PAS DE SOUDURE OU DE PIÈCE INTERMÉDIAIRE NÉCESSAIRE

98571 FLEXIBLE STRIPE

bar / strip light; plastic, white
 Leuchtband/-stab; Kunststoff, weiss
 bande lumineuse / bâton l; plastique, blanc

L 2000, B 6



9,6W 1050lm



9 002759 985714

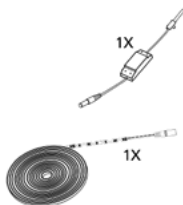

L 2000

98572 FLEXIBLE STRIPE

bar / strip light; plastic, white
 Leuchtband/-stab; Kunststoff, weiss
 bande lumineuse / bâton l; plastique, blanc

L 5000, B 6



18,5W 2100lm



9 002759 985721

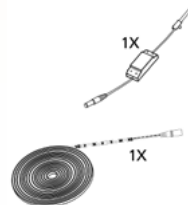

L 5000

99716 FLEXIBLE STRIPE

bar / strip light; white
 Leuchtband/-stab; weiss
 bande lumineuse / bâton l; blanc

L 8000, B 6



43,2W 4800lm



9 002759 997168

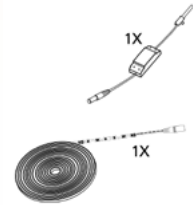

L 8000



99717



99718



99719



99717 FLEXIBLE STRIPE

bar / strip light; white
 Leuchtband/-stab; weiss
 bande lumineuse / bâton l; blanc

L 2000, B 6



10,8W 1200lm



9 002759 997175

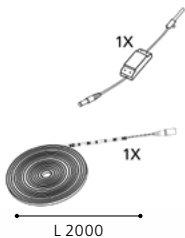

L 2000

99718 FLEXIBLE STRIPE

bar / strip light; white
 Leuchtband/-stab; weiss
 bande lumineuse / bâton l; blanc

L 5000, B 6



27W 3000lm



9 002759 997182

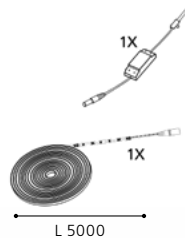

L 5000

99719 FLEXIBLE STRIPE

bar / strip light; white
 Leuchtband/-stab; weiss
 bande lumineuse / bâton l; blanc

L 8000, B 8



43,2W 4800lm



9 002759 997199

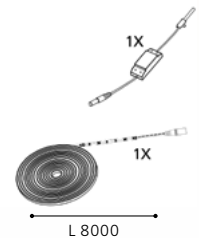

L 8000



99721



99722



99723



99721, 99722, 99723

These articles include a remote control.

Bei diesen Artikeln ist eine Fernbedienung inkludiert.

Ces articles comprennent une télécommande.

99721 FLEXIBLE STRIPE

bar / strip light; white
Leuchtband/-stab; weiss
bande lumineuse / bâton l; blanc

L 2000, B 8

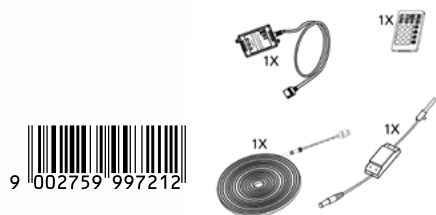

L 2000

99722 FLEXIBLE STRIPE

bar / strip light; white
Leuchtband/-stab; weiss
bande lumineuse / bâton l; blanc

L 5000, B 8

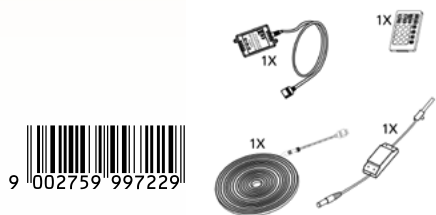

L 5000

99723 FLEXIBLE STRIPE

bar / strip light; white
Leuchtband/-stab; weiss
bande lumineuse / bâton l; blanc

L 8000, B 8

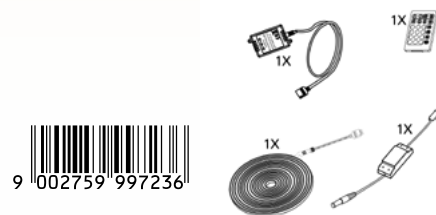

L 8000

98573

LED

98574

LED



98573 FLEXIBLE STRIPE

bar / strip light; plastic, white
Leuchtband/-stab; Kunststoff, weiss
bande lumineuse / bâton l; plastique, blanc

L 2000, B 8



9,7W



L 2000



9 002759 985738

98574 FLEXIBLE STRIPE

bar / strip light; plastic, white
Leuchtband/-stab; Kunststoff, weiss
bande lumineuse / bâton l; plastique, blanc

L 5000, B 8



19,5W



L 5000



9 002759 985745

98573, 98574

These articles include a remote control.

Bei diesen Artikeln ist eine Fernbedienung inkludiert.

Ces articles comprennent une télécommande.

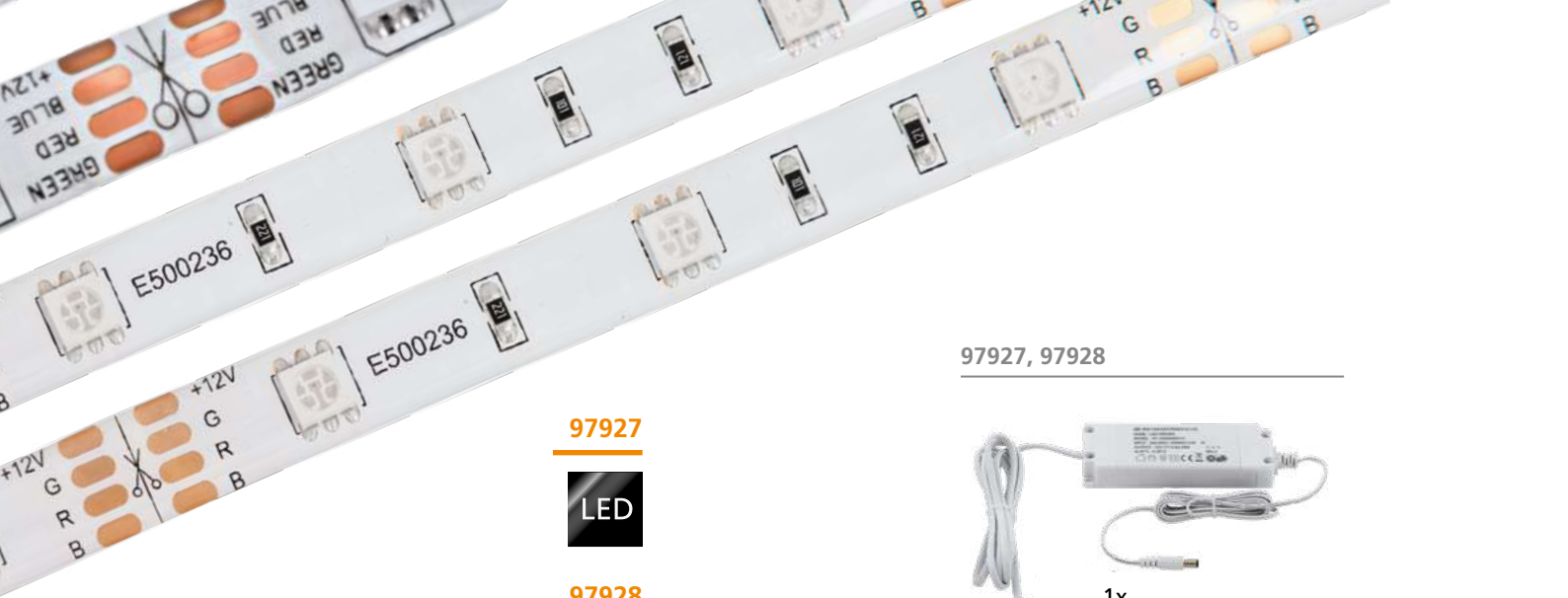

97927, 97928

97927

LED

97928

LED

97924

LED



REMOTE CONTROL

With the aid of the remote control, all LED STRIPES can be dimmed. The "not dimmable" sign shown in the technical info is only valid for utilisation without the remote control.

Mit Hilfe der Fernbedienung können sämtliche LED-STRIPES gedimmt werden. Das „nicht dimmbar“ Zeichen in der technischen Information trifft nur für die Benutzung ohne Fernbedienung zu.

Au moyen de la télécommande, tous les LED STRIPES peuvent être gradués. Le signe « non graduable » dans l'information technique n'est valable que dans le cas d'utilisation sans télécommande.

*This note indicates that the remote control is included with the delivery.

*Bei diesem Hinweis ist die Fernbedienung im Lieferumfang enthalten!

*Avec cette remarque, la télécommande est comprise dans l'étendue de la livraison !

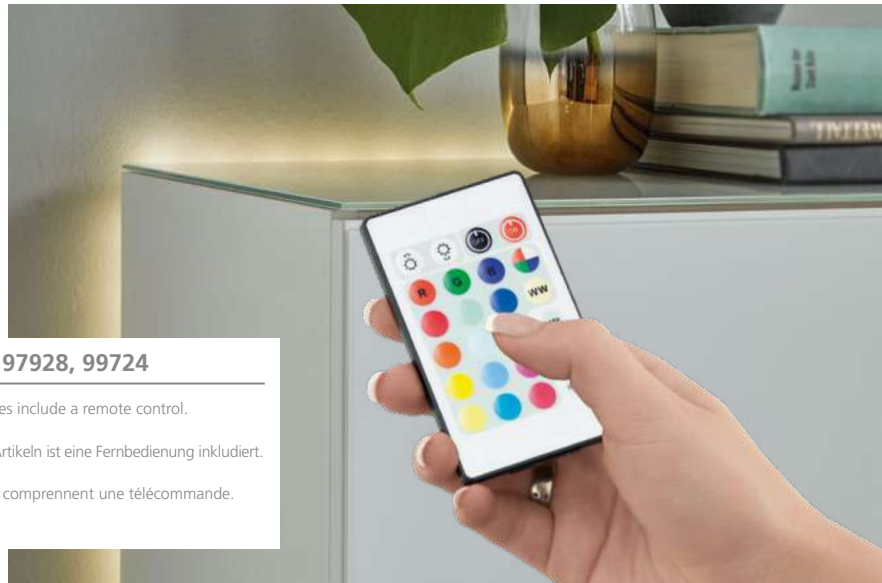

97927, 97928, 97924

These articles include a remote control.

Bei diesen Artikeln ist eine Fernbedienung inkludiert.

Ces articles comprennent une télécommande.

97924 FLEXIBLE STRIPE

bar / strip light; white
Leuchtband/-stab; weiss
bande lumineuse / bâton l; blanc

L 8000, B 8



38,4W



L 8000



9 002759 997243

97928 LED STRIPES-FLEX

bar / strip light; plastic, transparent
Leuchtband/-stab; Kunststoff, transparent
bande lumineuse / bâton l; plastique, transparent

L 5000, B 10, H 3



20W

1000lm

remote



10

L 5000



9 002759 979287



97927 LED STRIPES-FLEX

bar / strip light; plastic, transparent
Leuchtband/-stab; Kunststoff, transparent
bande lumineuse / bâton l; plastique, transparent

L 2000, B 10, H 3



10W

600lm

remote



10

L 2000



9 002759 979270



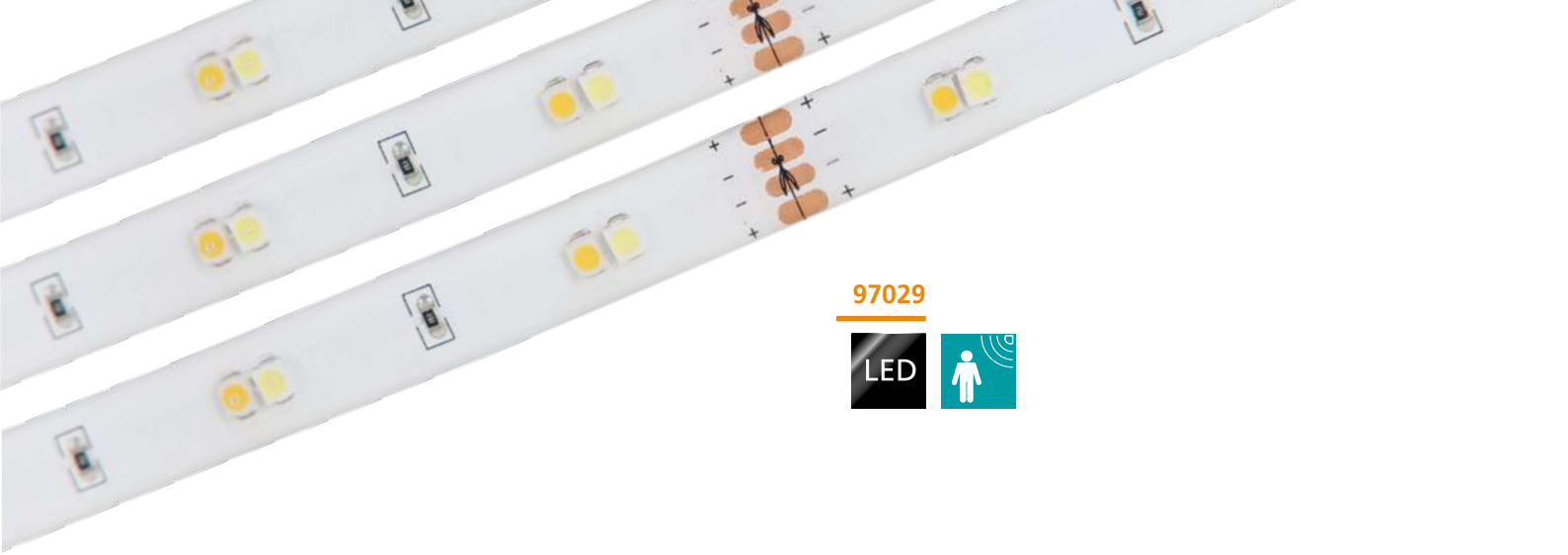

97029



97029

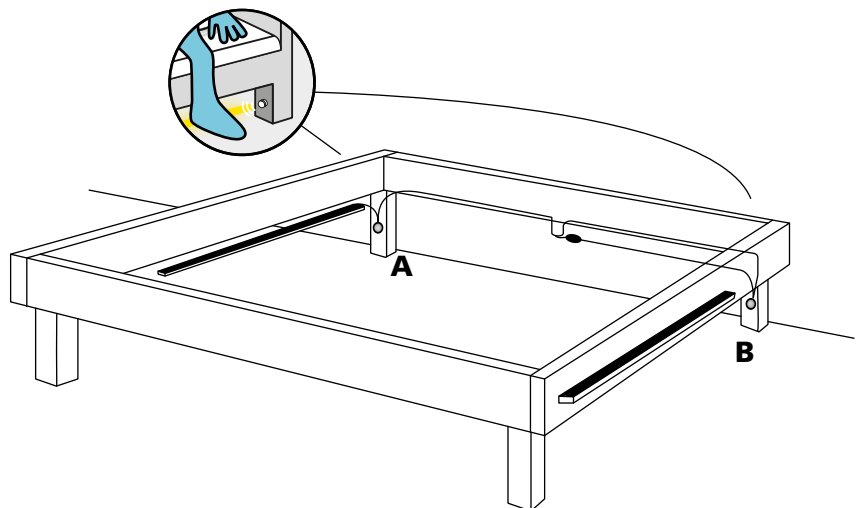

97029 PIDIO

bar / strip light; plastic, white
 Leuchtband/-stab; Kunststoff, weiss
 bande lumineuse / bâton l; plastique, blanc

L 2400, B 8, H 2



36x 0,1W 225lm 36x 0,1W



10



97029 PIDIO

This sensor strip is designed to be attached to the side of the bed. Properly placed and connected to the supplied LED lights, it will illuminate the base of your bed. The sensor has a 100 degree detection angle and a 3.5m range. It can be set to automatically activate the light between 30 seconds and 10 minutes.

Diese Sensorleiste ist so konzipiert, dass sie an der Seite des Bettes befestigt werden kann. Richtig platziert und mit den mitgelieferten LED-Streifenleuchten verbunden, kann damit ihr Bett unterleuchtet werden. Der Sensor hat einen 100 Grad Erfassungsbereich mit einer Reichweite von 3,5 m Reichweite. Er kann so eingestellt werden, dass das Licht zwischen 30 Sekunden und 10 Minuten automatisch aktiviert wird.

Cette barre de capteur est conçu de telle sorte qu'il peut être fixé sur le côté du lit. Correctement placé et connecté à la bande LED fournis, il allume la base du lit. Le capteur a un arc de 100 degrés et une portée de 3,5 m. Il peut être réglé de telle sorte que la lumière est activé entre 30 secondes et 10 minutes automatiquement.



LED PROFILES

ADVANTAGES

- > SIMPLE AND FAST INSTALLATION
 - > DIFFERENT SHAPES AND SIZES
 - > VARIETY OF COLOURS
 - > PROFILES GIVE LED STRIPES A MORE ELEGANT DESIGN
 - > PROTECTION AGAINST MECHANICAL STRESS OF THE LED STRIPES
-





























VORTEILE

- > EINFACHE UND SCHNELLE MONTAGE
 - > UNTERSCHIEDLICHE FORMEN UND GRÖSSEN
 - > FARBENVIELFALT
 - > PROFILE VERLEIHEN LED-STRIPES EIN EDLERES DESIGN
 - > SCHUTZ VOR MECHANISCHER BEANSPRUCHUNG DER LED STRIPES
-

ADVANTAGES

- > INSTALLATION SIMPLE ET RAPIDE
- > DIFFÉRENTES FORMES ET TAILLES
- > VARIÉTÉ DE COULEURS
- > LES PROFILS DONNENT AUX BANDES LED UN DESIGN PLUS ÉLÉGANT
- > PROTECTION CONTRE LES CONTRAINTES MÉCANIQUES DES BANDES LED

OVERVIEW

							
SURFACE PROFILE 1 p. 270-272	SURFACE PROFILE 1 p. 270-272	SURFACE PROFILE 1 p. 270-272	SURFACE PROFILE 2 p. 273-275	SURFACE PROFILE 2 p. 273-275	SURFACE PROFILE 2 p. 273-275	SURFACE PROFILE 3 p. 276-278	SURFACE PROFILE 3 p. 276-278
							
SURFACE PROFILE 3 p. 276-278	CORNER PROFILE 1 p. 280-285	CORNER PROFILE 1 p. 280-285	CORNER PROFILE 1 p. 280-285	CORNER PROFILE 2 p. 286-291	CORNER PROFILE 2 p. 286-291	CORNER PROFILE 2 p. 286-291	SURFACE PROFILE 4 p. 292-293
							
SURFACE PROFILE 4 p. 292-293	SURFACE PROFILE 4 p. 292-293	RECESSED PROFILE 1 p. 294-296	RECESSED PROFILE 1 p. 294-296	RECESSED PROFILE 1 p. 294-296	RECESSED PROFILE 2 p. 297-299	RECESSED PROFILE 2 p. 297-299	RECESSED PROFILE 2 p. 297-299
							
SURFACE PROFILE 5 p. 300	RECESSED PROFILE 3 p. 302-303	RECESSED PROFILE 3 p. 302-303	RECESSED PROFILE 3 p. 302-303	SURFACE PROFILE 6 p. 304-305	SURFACE PROFILE 6 p. 304-305	SURFACE PROFILE 6 p. 304-305	RECESSED PROFILE 4 p. 306-309
							
RECESSED PROFILE 4 p. 306-309							

 This product is available in different colors and shapes./ Dieser Artikel ist in unterschiedlichen Farben und Formen verfügbar.
Cet article est disponible en différentes couleurs et formes.



LED CORNER CONNECTORS

ADVANTAGES

- > PREFABRICATED 90° CORNER CONNECTORS
 - > NO MITRE SAWING NECESSARY
 - > EASY MOUNTING
 - > SUITABLE FOR INSIDE AND OUTSIDE CORNERS
 - > BRACKETS INCLUDED
-

VORTEILE

- > VORGEFERTIGTE 90° ECKVERBINDER
 - > KEIN GEHRUNGSSÄGEN NOTWENDIG
 - > EINFACHE MONTAGE
 - > FÜR INNEN- UND AUSSENECKEN EINSETZBAR
 - > HALTERUNGEN INKLUSIVE
-

ADVANTAGES

- > CONNECTEURS D'ANGLE À 90° PRÉFABRIQUÉS
- > PAS DE SCIAGE EN ONGLET NÉCESSAIRE
- > MONTAGE FACILE
- > CONVIENT AUX ANGLES INTÉRIEURS ET EXTÉRIEURS
- > ENTRE PARENTHÈSES

1

x2

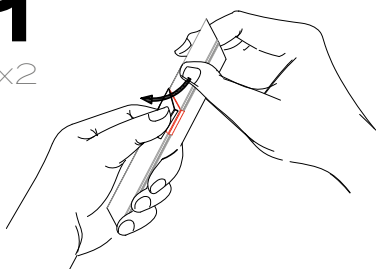

2

x2

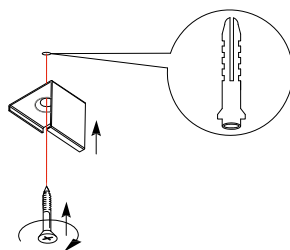

3

x2

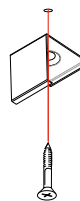

4

x2

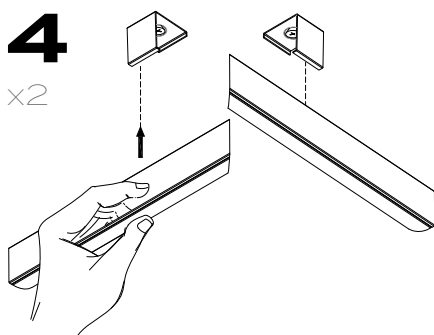

5

x2

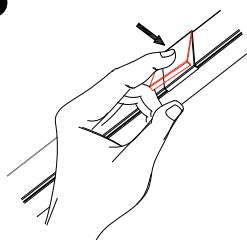

6

x2

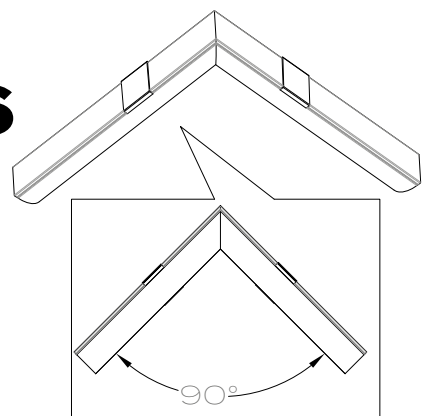

OVERVIEW



SURFACE
PROFILE 1
p. 270



SURFACE
PROFILE 1
p. 271



SURFACE
PROFILE 1
p. 272



SURFACE
PROFILE 2
p. 273



SURFACE
PROFILE 2
p. 274



SURFACE
PROFILE 2
p. 275



SURFACE
PROFILE 3
p. 276



SURFACE
PROFILE 3
p. 277



SURFACE
PROFILE 3
p. 278



CORNER
PROFILE 1
p. 280



CORNER
PROFILE 1
p. 281



CORNER
PROFILE 1
p. 282



CORNER
PROFILE 1
p. 283



CORNER
PROFILE 1
p. 284



CORNER
PROFILE 1
p. 285



CORNER
PROFILE 2
p. 286



CORNER
PROFILE 2
p. 287



CORNER
PROFILE 2
p. 288



CORNER
PROFILE 2
p. 289



CORNER
PROFILE 2
p. 290



CORNER
PROFILE 2
p. 291



RECESSED
PROFILE 1
p. 294



RECESSED
PROFILE 1
p. 295



RECESSED
PROFILE 1
p. 296



RECESSED
PROFILE 2
p. 297



RECESSED
PROFILE 2
p. 298



RECESSED
PROFILE 2
p. 299

INCLUDED IN DELIVERY /
im Lieferumfang enthalten /
inclus dans la livraison



98911
98912



98914
98915

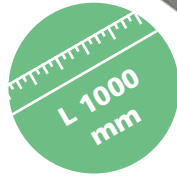

98911

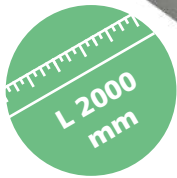

98912



98913

98911 SURFACE PROFILE 1

accessory; aluminium, aluminium / plastic, white
Zubehör; Alu, alu / Kunststoff, weiss
accessoire; aluminium, aluminium / plastique, blanc

L 1000, B 17, H 9



9 002759 989118

98912 SURFACE PROFILE 1

accessory; aluminium, aluminium / plastic, white
Zubehör; Alu, alu / Kunststoff, weiss
accessoire; aluminium, aluminium / plastique, blanc

L 2000, B 17, H 9



9 002759 989125

98913 SURFACE PROFILE 1

accessory; aluminium, aluminium
Zubehör; Alu, alu
accessoire; aluminium, aluminium

L 110



9 002759 989132

SURFACE PROFILES

incl. end caps & mounting clips



98914

L 1000
mm



98915

L 2000
mm



98916

98914 SURFACE PROFILE 1

accessory; aluminium, white / plastic, white
Zubehör; Alu, weiss / Kunststoff, weiss
accessoire; aluminium, blanc / plastique, blanc

L 1000, B 17, H 9



9 002759 989149

98915 SURFACE PROFILE 1

accessory; aluminium, white / plastic, white
Zubehör; Alu, weiss / Kunststoff, weiss
accessoire; aluminium, blanc / plastique, blanc

L 2000, B 17, H 9



9 002759 989156

98916 SURFACE PROFILE 1

accessory; aluminium, white
Zubehör; Alu, weiss
accessoire; aluminium, blanc

L 110



9 002759 989163

PROFILE CROSS-SECTION /
Profilquerschnitt / section de profil

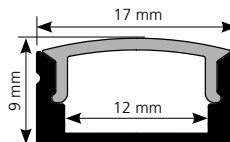

98911 98913 98915
98912 98914 98916

INCLUDED IN DELIVERY /
im Lieferumfang enthalten /
inclus dans la livraison



98917
98918



98921
98922



L 1000
mm

98917



L 2000
mm

98918



98919

98917 SURFACE PROFILE 1

accessory; aluminium, black / plastic, white
Zubehör; Alu, schwarz / Kunststoff, weiss
accessoire; aluminium, noir / plastique, blanc

L 1000, B 17, H 9



9 002759 989170

98918 SURFACE PROFILE 1

accessory; aluminium, black / plastic, white
Zubehör; Alu, schwarz / Kunststoff, weiss
accessoire; aluminium, noir / plastique, blanc

L 2000, B 17, H 9



9 002759 989187

98919 SURFACE PROFILE 1

accessory; aluminium, anodised black
Zubehör; Alu, schwarz eloxiert
accessoire; aluminium, noir anodisé

L 110



9 002759 989194

SURFACE PROFILES

incl. end caps & mounting clips

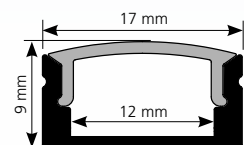

98917 98919
98918



L 1000
mm

98921



L 2000
mm

98922



98923

98921 SURFACE PROFILE 2

accessory; aluminium, aluminium / plastic, white
Zubehör; Alu, alu / Kunststoff, weiss
accessoire; aluminium, aluminium / plastique, blanc

L 1000, B 17, H 16



98922 SURFACE PROFILE 2

accessory; aluminium, aluminium / plastic, white
Zubehör; Alu, alu / Kunststoff, weiss
accessoire; aluminium, aluminium / plastique, blanc

L 2000, B 17, H 16



98923 SURFACE PROFILE 2

accessory; aluminium, aluminium
Zubehör; Alu, alu
accessoire; aluminium, aluminium

L 110



PROFILE CROSS-SECTION / Profilquerschnitt / section de profil

98921 98923
98922

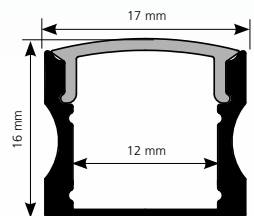



L 1000
mm

98924



L 2000
mm

98925

INCLUDED IN DELIVERY /
im Lieferumfang enthalten /
inclus dans la livraison



98924
98925



98927
98928



98926

98924 SURFACE PROFILE 2

accessory; aluminium, white / plastic, white
Zubehör; Alu, weiss / Kunststoff, weiss
accessoire; aluminium, blanc / plastique, blanc

L 1000, B 17, H 16



9 002759 989248

98925 SURFACE PROFILE 2

accessory; aluminium, white / plastic, white
Zubehör; Alu, weiss / Kunststoff, weiss
accessoire; aluminium, blanc / plastique, blanc

L 2000, B 17, H 16



9 002759 989255

98926 SURFACE PROFILE 2

accessory; aluminium, white
Zubehör; Alu, weiss
accessoire; aluminium, blanc

L 110



9 002759 989262

SURFACE PROFILES

incl. end caps & mounting clips



98927 SURFACE PROFILE 2

accessory; aluminium, black / plastic, white
 Zubehör; Alu, schwarz / Kunststoff, weiss
 accessoire; aluminium, noir / plastique, blanc

L 1000, B 17, H 16



98928 SURFACE PROFILE 2

accessory; aluminium, black / plastic, white
 Zubehör; Alu, schwarz / Kunststoff, weiss
 accessoire; aluminium, noir / plastique, blanc

L 2000, B 17, H 16



98929 SURFACE PROFILE 2

accessory; aluminium, anodised black
 Zubehör; Alu, schwarz eloxiert
 accessoire; aluminium, noir anodisé

L 110



PROFILE CROSS-SECTION /
 Profilquerschnitt / section de profil

98924 98926 98928
 98925 98927 98929

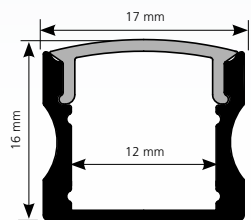

INCLUDED IN DELIVERY /
im Lieferumfang enthalten /
inclus dans la livraison



98931
98932



98937
98938



98931

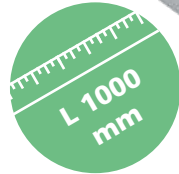

98932

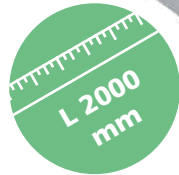

98933

98931 SURFACE PROFILE 3

accessory; aluminium, aluminium / plastic, transparent
Zubehör; Alu, alu / Kunststoff, transparent
accessoire; aluminium, aluminium / plastique, transparent

98932 SURFACE PROFILE 3

accessory; aluminium, aluminium / plastic, transparent
Zubehör; Alu, alu / Kunststoff, transparent
accessoire; aluminium, aluminium / plastique, transparent

98933 SURFACE PROFILE 3

accessory; aluminium, aluminium
Zubehör; Alu, alu
accessoire; aluminium, aluminium

L 1000, B 17, H 20



9 002759 989316

L 2000, B 17, H 20



9 002759 989323

L 110



9 002759 989330

SURFACE PROFILES WITH 30° LINEAR LENS

incl. end caps & mounting clips



98937

L 1000
mm



98938

L 2000
mm



98939

98937 SURFACE PROFILE 3

accessory; aluminium, black / plastic, transparent
Zubehör; Alu, schwarz / Kunststoff, transparent
accessoire; aluminium, noir / plastique, transparent

L 1000, B 17, H 20



98938 SURFACE PROFILE 3

accessory; aluminium, black / plastic, transparent
Zubehör; Alu, schwarz / Kunststoff, transparent
accessoire; aluminium, noir / plastique, transparent

L 2000, B 17, H 20



98939 SURFACE PROFILE 3

accessory; aluminium, anodised black
Zubehör; Alu, schwarz eloxiert
accessoire; aluminium, noir anodisé

L 110



PROFILE CROSS-SECTION / Profilquerschnitt / section de profil

98931 98933 98938
98932 98937 98939

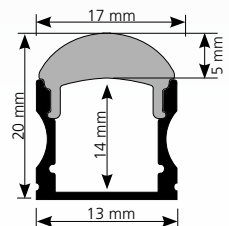

INCLUDED IN DELIVERY /
im Lieferumfang enthalten /
inclus dans la livraison



98934
98935



98934



98935



98936

98934 SURFACE PROFILE 3

accessory; aluminium, white / plastic, transparent
Zubehör; Alu, weiss / Kunststoff, transparent
accessoire; aluminium, blanc / plastique, transparent

L 1000, B 17, H 20



98935 SURFACE PROFILE 3

accessory; aluminium, white / plastic, transparent
Zubehör; Alu, weiss / Kunststoff, transparent
accessoire; aluminium, blanc / plastique, transparent

L 2000, B 17, H 20



98936 SURFACE PROFILE 3

accessory; aluminium, white
Zubehör; Alu, weiss
accessoire; aluminium, blanc

L 110



SURFACE PROFILES WITH 30° LINEAR LENS

incl. end caps & mounting clips



PROFILE CROSS-SECTION /
Profilquerschnitt / section de profil

98934 98936
98935

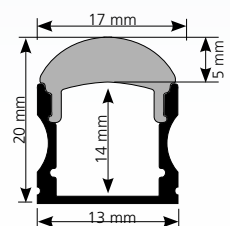

INCLUDED IN DELIVERY /
im Lieferumfang enthalten /
inclus dans la livraison



98941
98942

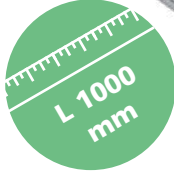

98941

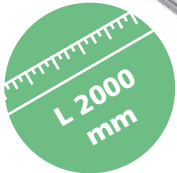

98942



98943

98941 CORNER PROFILE 1

accessory; aluminium, aluminium / plastic, white
Zubehör; Alu, alu / Kunststoff, weiss
accessoire; aluminium, aluminium / plastique, blanc

L 1000, H 16



9 002759 989415

98942 CORNER PROFILE 1

accessory; aluminium, aluminium / plastic, white
Zubehör; Alu, alu / Kunststoff, weiss
accessoire; aluminium, aluminium / plastique, blanc

L 2000, H 16



9 002759 989422

98943 CORNER PROFILE 1

accessory; aluminium, aluminium
Zubehör; Alu, alu
accessoire; aluminium, aluminium

L 110



9 002759 989439

CORNER PROFILES

incl. end caps & mounting clips

98944

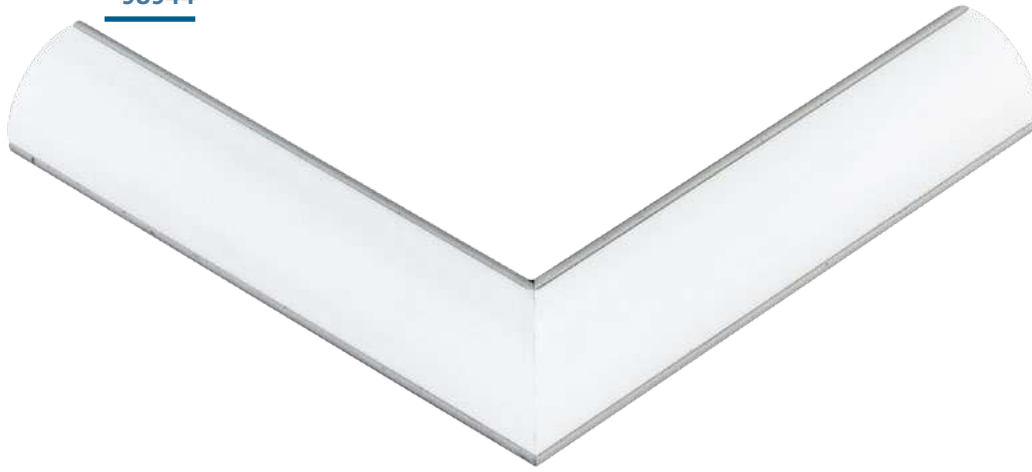

98944 CORNER PROFILE 1

accessory; aluminium, aluminium
Zubehör; Alu, alu
accessoire; aluminium, aluminium

L 110



PROFILE CROSS-SECTION /
Profilquerschnitt / section de profil

98941 98943
98942 98944

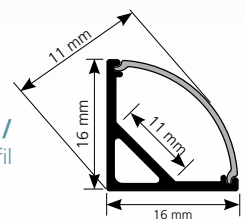

INCLUDED IN DELIVERY /
im Lieferumfang enthalten /
inclus dans la livraison



98945
98946

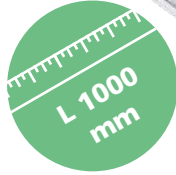

98945



98946



98947

98945 CORNER PROFILE 1

accessory; aluminium, white / plastic, white
Zubehör; Alu, weiss / Kunststoff, weiss
accessoire; aluminium, blanc / plastique, blanc

L 1000, H 16



9 002759 989453

98946 CORNER PROFILE 1

accessory; aluminium, white / plastic, white
Zubehör; Alu, weiss / Kunststoff, weiss
accessoire; aluminium, blanc / plastique, blanc

L 2000, H 16



9 002759 989460

98947 CORNER PROFILE 1

accessory; aluminium, white
Zubehör; Alu, weiss
accessoire; aluminium, blanc

L 110



9 002759 989477

PROFILE CROSS-SECTION /
Profilquerschnitt / section de profil

98945 98947
98946 98948

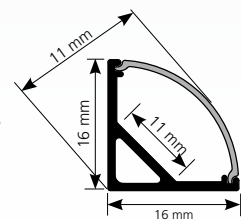

CORNER PROFILES

incl. end caps & mounting clips

98948

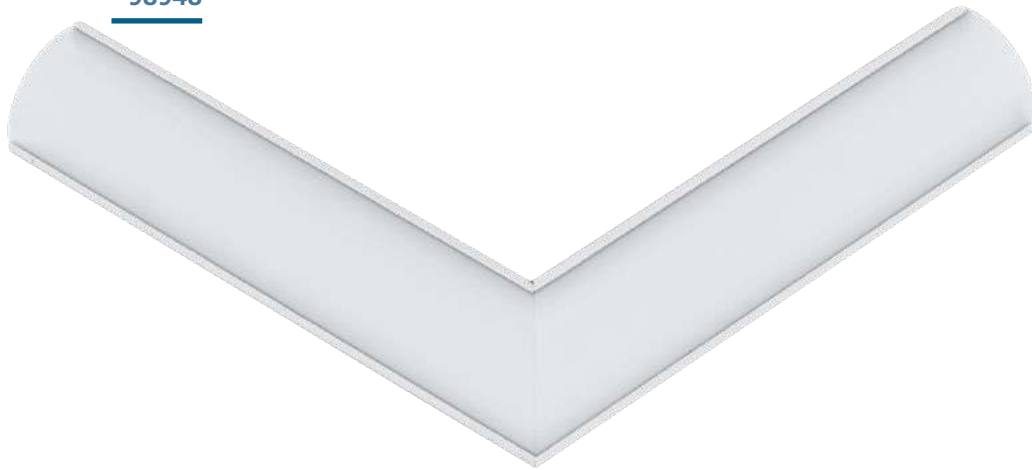

98948 CORNER PROFILE 1

accessory; aluminium, white
Zubehör; Alu, weiss
accessoire; aluminium, blanc

L 110

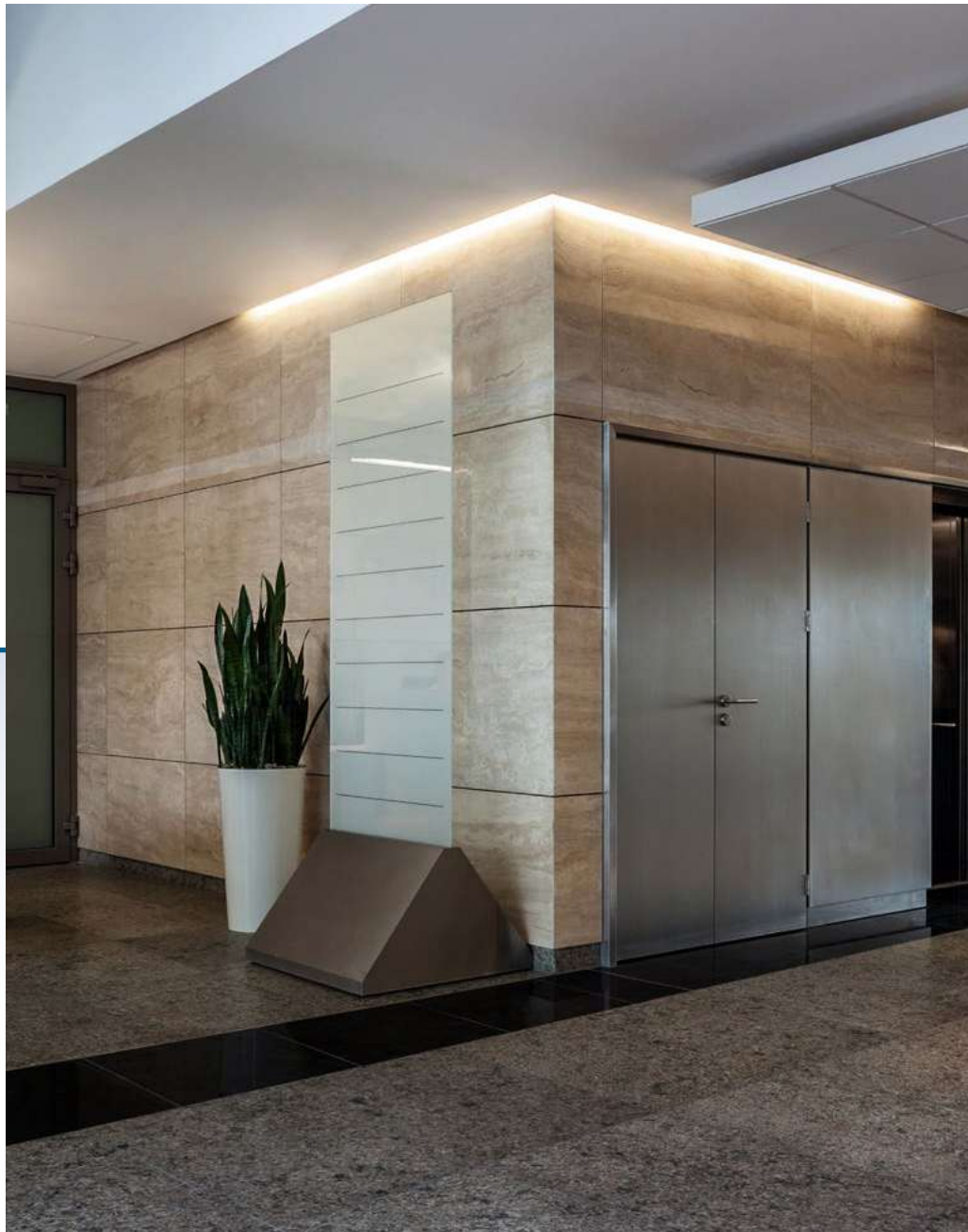

INCLUDED IN DELIVERY /

im Lieferumfang enthalten /
inclus dans la livraison



98949
98951

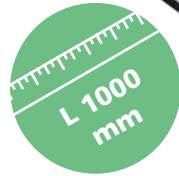

98949

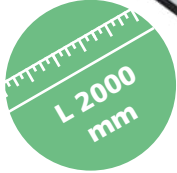

98951



98952

98949 CORNER PROFILE 1

accessory; aluminium, black / plastic, white
Zubehör; Alu, schwarz / Kunststoff, weiss
accessoire; aluminium, noir / plastique, blanc

L 1000, H 16



9 002759 989491

98951 CORNER PROFILE 1

accessory; aluminium, black / plastic, white
Zubehör; Alu, schwarz / Kunststoff, weiss
accessoire; aluminium, noir / plastique, blanc

L 2000, H 16



9 002759 989514

98952 CORNER PROFILE 1

accessory; aluminium, anodised black
Zubehör; Alu, schwarz eloxiert
accessoire; aluminium, noir anodisé

L 110



9 002759 989521

CORNER PROFILES

incl. end caps & mounting clips

98953

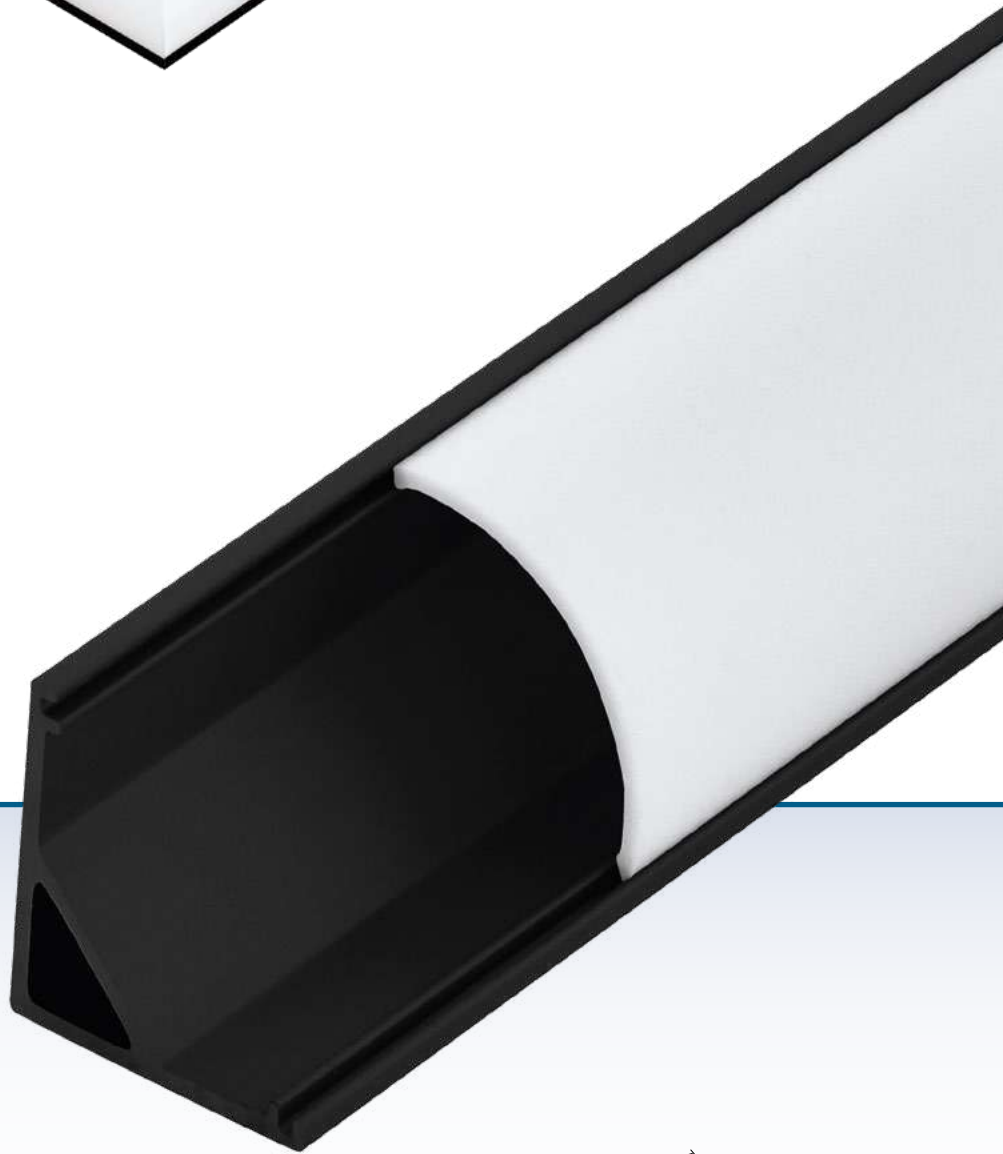
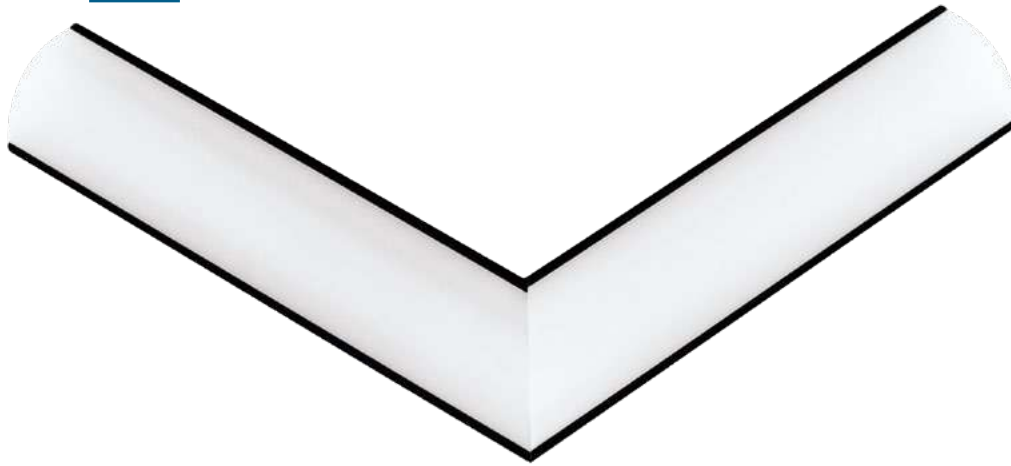

98953 CORNER PROFILE 1

accessory; aluminium, anodised black
Zubehör; Alu, schwarz eloxiert
accessoire; aluminium, noir anodisé

L 110



9 002759 989538

PROFILE CROSS-SECTION /
Profilquerschnitt / section de profil

98949 98952
98951 98953

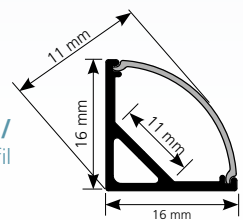

INCLUDED IN DELIVERY /
im Lieferumfang enthalten /
inclus dans la livraison



98954
98955

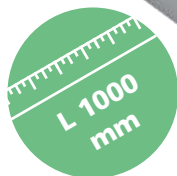

98954

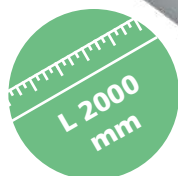

98955



98956

98954 CORNER PROFILE 2

accessory; aluminium, aluminium / plastic, white
Zubehör; Alu, alu / Kunststoff, weiss
accessoire; aluminium, aluminium / plastique, blanc

L 1000, B 18, H 18



9 002759 989545

98955 CORNER PROFILE 2

accessory; aluminium, aluminium / plastic, white
Zubehör; Alu, alu / Kunststoff, weiss
accessoire; aluminium, aluminium / plastique, blanc

L 2000, B 18, H 18



9 002759 989552

98956 CORNER PROFILE 2

accessory; aluminium, aluminium
Zubehör; Alu, alu
accessoire; aluminium, aluminium

L 110



9 002759 989569

CORNER PROFILES

incl. end caps & mounting clips

PROFILE CROSS-SECTION / Profilquerschnitt / section de profil

98954 98956
98955 98957

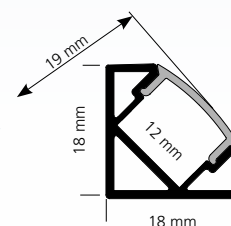

98957



98957 CORNER PROFILE 2

accessory; aluminium, aluminium
Zubehör; Alu, alu
accessoire; aluminium, aluminium

L 110



INCLUDED IN DELIVERY /
im Lieferumfang enthalten /
inclus dans la livraison



98958
98959

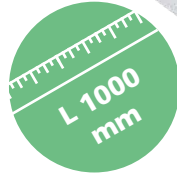

98958



98959



98961

98958 CORNER PROFILE 2

accessory; aluminium, white / plastic, white
Zubehör; Alu, weiss / Kunststoff, weiss
accessoire; aluminium, blanc / plastique, blanc

98959 CORNER PROFILE 2

accessory; aluminium, white / plastic, white
Zubehör; Alu, weiss / Kunststoff, weiss
accessoire; aluminium, blanc / plastique, blanc

98961 CORNER PROFILE 2

accessory; aluminium, white
Zubehör; Alu, weiss
accessoire; aluminium, blanc

L 1000, B 18, H 18



9 002759 989583

L 2000, B 18, H 18



9 002759 989590

L 110



9 002759 989613

CORNER PROFILES

incl. end caps & mounting clips

98962



98962 CORNER PROFILE 2

accessory; aluminium, white
Zubehör; Alu, weiss
accessoire; aluminium, blanc

L 110



PROFILE CROSS-SECTION /
Profilquerschnitt / section de profil

98958 98961
98959 98962

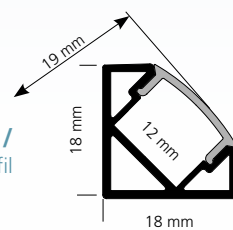

INCLUDED IN DELIVERY /
im Lieferumfang enthalten /
inclus dans la livraison



98963
98964

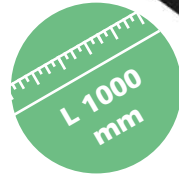

98963



98964



98965

98963 CORNER PROFILE 2

accessory; aluminium, black / plastic, white
Zubehör; Alu, schwarz / Kunststoff, weiss
accessoire; aluminium, noir / plastique, blanc

98964 CORNER PROFILE 2

accessory; aluminium, black / plastic, white
Zubehör; Alu, schwarz / Kunststoff, weiss
accessoire; aluminium, noir / plastique, blanc

98965 CORNER PROFILE 2

accessory; aluminium, anodised black
Zubehör; Alu, schwarz eloxiert
accessoire; aluminium, noir anodisé

L 1000, B 18, H 18



9 002759 989637

L 2000, B 18, H 18



9 002759 989644

L 110



9 002759 989651

CORNER PROFILES

incl. end caps & mounting clips

98966

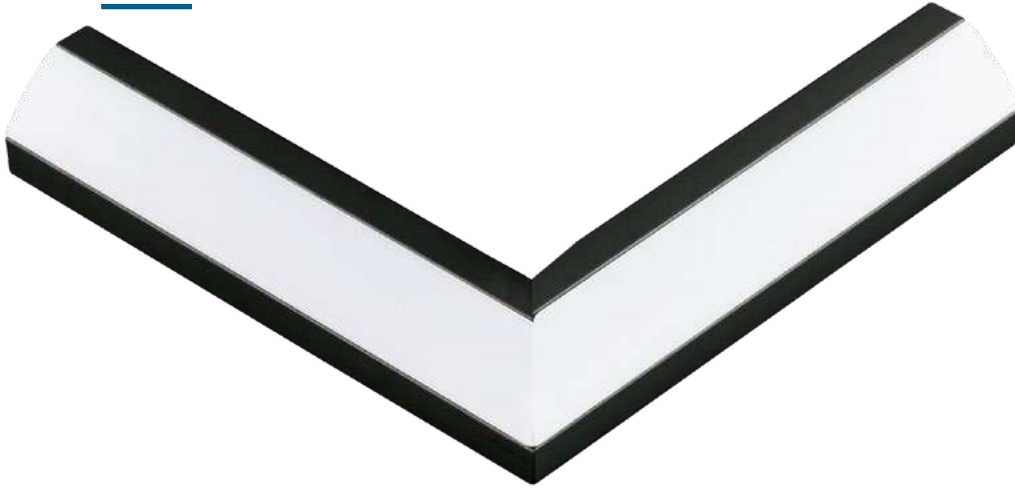

98966 CORNER PROFILE 2

accessory; aluminium, anodised black
Zubehör; Alu, schwarz eloxiert
accessoire; aluminium, noir anodisé

L 110



9 002759 989668

PROFILE CROSS-SECTION /
Profilquerschnitt / section de profil

98963 98965
98964 98966

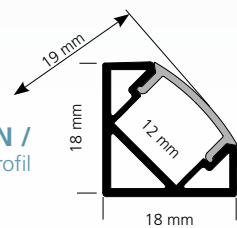



INCLUDED IN DELIVERY /
im Lieferumfang enthalten /
inclus dans la livraison



98967
98968



98971
98972



98974
98975

98967 SURFACE PROFILE 4

accessory; aluminium, aluminium / plastic, satined
Zubehör; Alu, alu / Kunststoff, satiniert
accessoire; aluminium, aluminium / plastique, satiné

L 1000, B 18, H 48



9 002759 989675

98968 SURFACE PROFILE 4

accessory; aluminium, aluminium / plastic, satined
Zubehör; Alu, alu / Kunststoff, satiniert
accessoire; aluminium, aluminium / plastique, satiné

L 2000, B 18, H 48



9 002759 989682

98971 SURFACE PROFILE 4

accessory; aluminium, white / plastic, satined
Zubehör; Alu, weiss / Kunststoff, satiniert
accessoire; aluminium, blanc / plastique, satiné

L 1000, B 18, H 48



9 002759 989712

WALL CONSTRUCTION PROFILES

incl. end caps & mounting clips



98972



98974

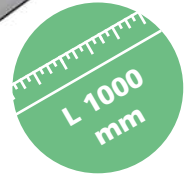

98975

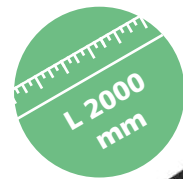

98972 SURFACE PROFILE 4

accessory; aluminium, white / plastic, satiné
 Zubehör; Alu, weiss / Kunststoff, satiniert
 accessoire; aluminium, blanc / plastique, satiné

L 2000, B 18, H 48



9 002759 989729

98974 SURFACE PROFILE 4

accessory; aluminium, black / plastic, satiné
 Zubehör; Alu, schwarz / Kunststoff, satiniert
 accessoire; aluminium, noir / plastique, satiné

L 1000, B 18, H 48



9 002759 989743

98975 SURFACE PROFILE 4

accessory; aluminium, black / plastic, satiné
 Zubehör; Alu, schwarz / Kunststoff, satiniert
 accessoire; aluminium, noir / plastique, satiné

L 2000, B 18, H 48



9 002759 989750

PROFILE CROSS-SECTION /
 Profilquerschnitt / section de profil

98967 98971 98974
 98968 98972 98975

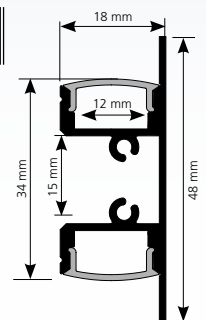

INCLUDED IN DELIVERY /
im Lieferumfang enthalten /
inclus dans la livraison



98977
98978



98981
98982



98977

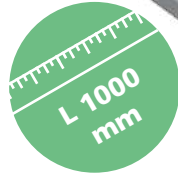

98978

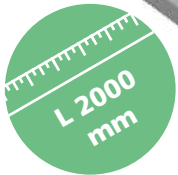

98979

98977 RECESSED PROFILE 1

accessory; aluminium, aluminium / plastic, white
Zubehör; Alu, alu / Kunststoff, weiss
accessoire; aluminium, aluminium / plastique, blanc

L 1000, B 23, H 9



9 002759 989774

98978 RECESSED PROFILE 1

accessory; aluminium, aluminium / plastic, white
Zubehör; Alu, alu / Kunststoff, weiss
accessoire; aluminium, aluminium / plastique, blanc

L 2000, B 23, H 9



9 002759 989781

98979 RECESSED PROFILE 1

accessory; aluminium, aluminium
Zubehör; Alu, alu
accessoire; aluminium, aluminium

L 110



9 002759 989798

INSTALLATION PROFILES

incl. end caps & mounting clips



98981

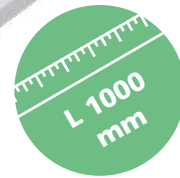

98982

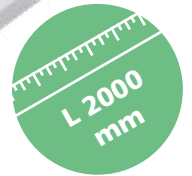

98983

98981 RECESSED PROFILE 1

accessory; aluminium, white / plastic, white
Zubehör; Alu, weiss / Kunststoff, weiss
accessoire; aluminium, blanc / plastique, blanc

L 1000, B 23, H 9



98982 RECESSED PROFILE 1

accessory; aluminium, white / plastic, white
Zubehör; Alu, weiss / Kunststoff, weiss
accessoire; aluminium, blanc / plastique, blanc

L 2000, B 23, H 9



98983 RECESSED PROFILE 1

accessory; aluminium, white
Zubehör; Alu, weiss
accessoire; aluminium, blanc

L 110



PROFILE CROSS-SECTION / Profilquerschnitt / section de profil

98977 98979 98982
98978 98981 98983

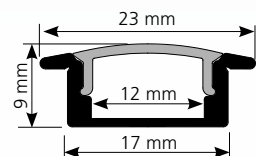

INCLUDED IN DELIVERY /
im Lieferumfang enthalten /
inclus dans la livraison

98984
98985

98987
98988

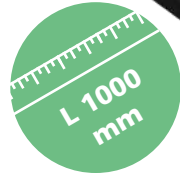

98984

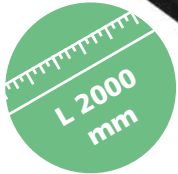

98985

98986

98984 RECESSED PROFILE 1

accessory; aluminium, black / plastic, white
Zubehör; Alu, schwarz / Kunststoff, weiss
accessoire; aluminium, noir / plastique, blanc

L 1000, B 23, H 9



9 002759 989842

98985 RECESSED PROFILE 1

accessory; aluminium, black / plastic, white
Zubehör; Alu, schwarz / Kunststoff, weiss
accessoire; aluminium, noir / plastique, blanc

L 2000, B 23, H 9



9 002759 989859

98986 RECESSED PROFILE 1

accessory; aluminium, anodised black
Zubehör; Alu, schwarz eloxiert
accessoire; aluminium, noir anodisé

L 110



9 002759 989866

INSTALLATION PROFILES

incl. end caps

PROFILE CROSS-SECTION /
Profilquerschnitt / section de profil

98984 98986
98985

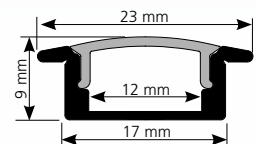



98987

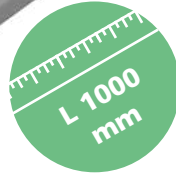

L 1000
mm



98988

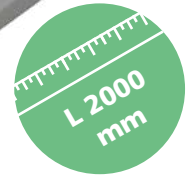

L 2000
mm



98989

98987 RECESSED PROFILE 2

accessory; aluminium, aluminium / plastic, white
Zubehör; Alu, alu / Kunststoff, weiss
accessoire; aluminium, aluminium / plastique, blanc

L 1000, B 23, H 15



9 002759 989873

98988 RECESSED PROFILE 2

accessory; aluminium, aluminium / plastic, white
Zubehör; Alu, alu / Kunststoff, weiss
accessoire; aluminium, aluminium / plastique, blanc

L 2000, B 23, H 15



9 002759 989880

98989 RECESSED PROFILE 2

accessory; aluminium, aluminium
Zubehör; Alu, alu
accessoire; aluminium, aluminium

L 110



9 002759 989897

PROFILE CROSS-SECTION / Profilquerschnitt / section de profil

98987 98989
98988

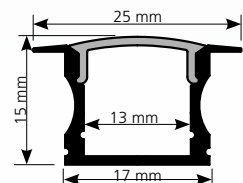

INCLUDED IN DELIVERY /

im Lieferumfang enthalten /
inclus dans la livraison



98991
98992



98994
98995

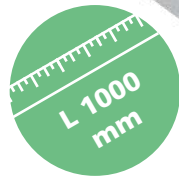

98991

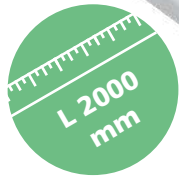

98992



98993

98991 RECESSED PROFILE 2

accessory; aluminium, white / plastic, white
Zubehör; Alu, weiss / Kunststoff, weiss
accessoire; aluminium, blanc / plastique, blanc

L 1000, B 23, H 15



9 002759 989910

98992 RECESSED PROFILE 2

accessory; aluminium, white / plastic, white
Zubehör; Alu, weiss / Kunststoff, weiss
accessoire; aluminium, blanc / plastique, blanc

L 2000, B 23, H 15



9 002759 989927

98993 RECESSED PROFILE 2

accessory; aluminium, white
Zubehör; Alu, weiss
accessoire; aluminium, blanc

L 110



9 002759 989934

INSTALLATION PROFILES

incl. end caps

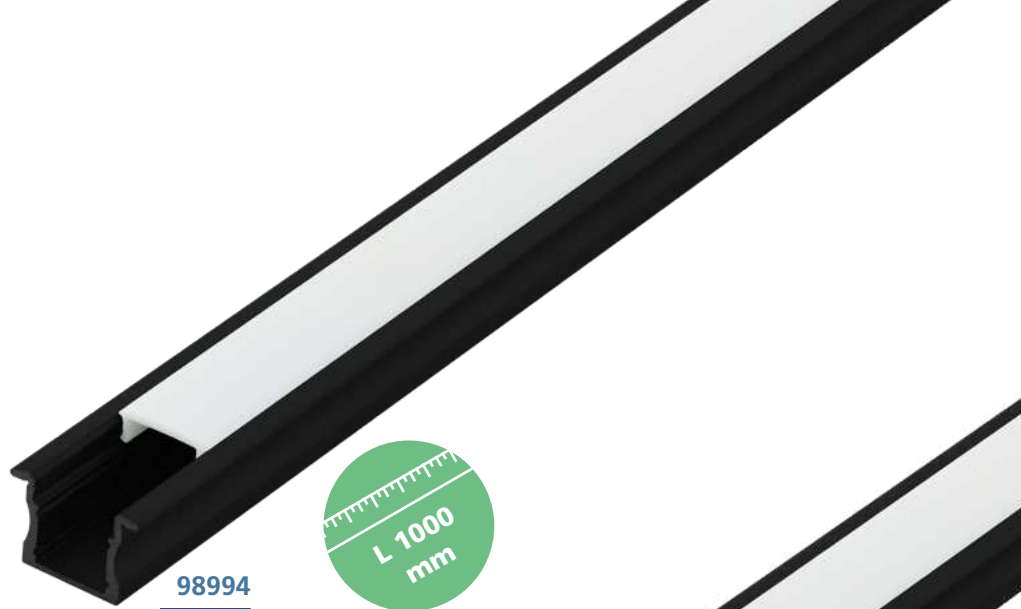

98994

L 1000
mm



98995

L 2000
mm



98996

98994 RECESSED PROFILE 2

accessory; aluminium, black / plastic, white
Zubehör; Alu, schwarz / Kunststoff, weiss
accessoire; aluminium, noir / plastique, blanc

L 1000, B 23, H 15



9 002759 989941

98995 RECESSED PROFILE 2

accessory; aluminium, black / plastic, white
Zubehör; Alu, schwarz / Kunststoff, weiss
accessoire; aluminium, noir / plastique, blanc

L 2000, B 23, H 15



9 002759 989958

98996 RECESSED PROFILE 2

accessory; aluminium, anodised black
Zubehör; Alu, schwarz eloxiert
accessoire; aluminium, noir anodisé

L 110



9 002759 989965

PROFILE CROSS-SECTION / Profilquerschnitt / section de profil

98991 98993 98995
98992 98994 98996

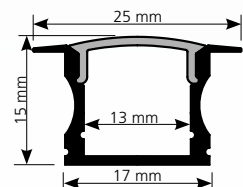

INCLUDED IN DELIVERY /
im Lieferumfang enthalten /
inclus dans la livraison



98997
98998

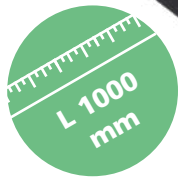

98997

98998



98997 SURFACE PROFILE 5

accessory; aluminium, black / plastic, white
Zubehör; Alu, schwarz / Kunststoff, weiss
accessoire; aluminium, noir / plastique, blanc

98998 SURFACE PROFILE 5

accessory; aluminium, black / plastic, white
Zubehör; Alu, schwarz / Kunststoff, weiss
accessoire; aluminium, noir / plastique, blanc

L 1000, B 80, H 50



9 002759 989972

L 2000, B 80, H 50



9 002759 989989

PROFILE CROSS-SECTION / Profilquerschnitt / section de profil

98997 98998

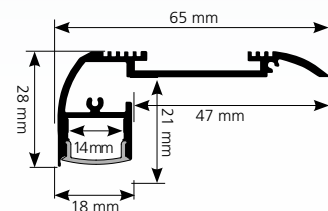

STAIR PROFILES

incl. end caps



INCLUDED IN DELIVERY /
im Lieferumfang enthalten /
inclus dans la livraison



99004
99005



99003
99002



98999
99001



99003

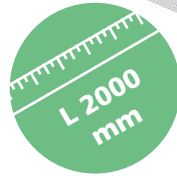

99002

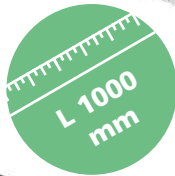

99005

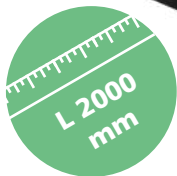

99003 RECESSED PROFILE 3

accessory; aluminium, white / plastic, white
Zubehör; Alu, weiss / Kunststoff, weiss
accessoire; aluminium, blanc / plastique, blanc

L 2000, B 65, H 45



9 002759 990039

99002 RECESSED PROFILE 3

accessory; aluminium, white / plastic, white
Zubehör; Alu, weiss / Kunststoff, weiss
accessoire; aluminium, blanc / plastique, blanc

L 1000, B 65, H 45



9 002759 990022

99005 RECESSED PROFILE 3

accessory; aluminium, black / plastic, white
Zubehör; Alu, schwarz / Kunststoff, weiss
accessoire; aluminium, noir / plastique, blanc

L 2000, B 65, H 45



9 002759 990053

INSTALLATION PROFILES LARGE

incl. end caps

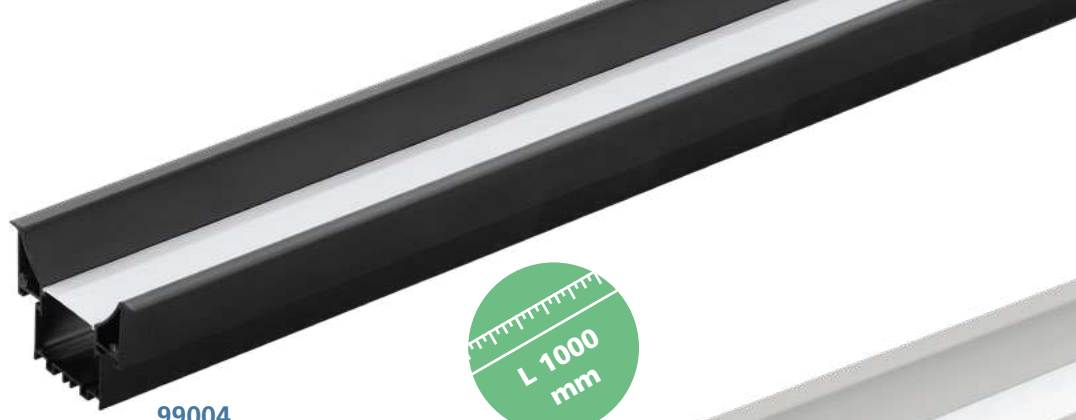

99004



98999



99001

99004 RECESSED PROFILE 3

accessory; aluminium, black / plastic, white
Zubehör; Alu, schwarz / Kunststoff, weiss
accessoire; aluminium, noir / plastique, blanc

L 1000, B 65, H 45



9 002759 990046

98999 RECESSED PROFILE 3

accessory; aluminium, aluminium / plastic, white
Zubehör; Alu, alu / Kunststoff, weiss
accessoire; aluminium, aluminium / plastique, blanc

L 1000, B 65, H 45



9 002759 989996

99001 RECESSED PROFILE 3

accessory; aluminium, aluminium / plastic, white
Zubehör; Alu, alu / Kunststoff, weiss
accessoire; aluminium, aluminium / plastique, blanc

L 2000, B 65, H 45



9 002759 990015

PROFILE CROSS-SECTION /
Profilquerschnitt / section de profil

98999 99002 99004
99001 99003 99005

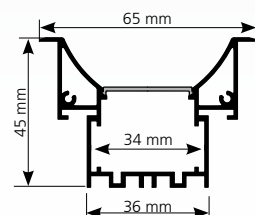

INCLUDED IN DELIVERY /
im Lieferumfang enthalten /
inclus dans la livraison



99006
99007



99008
99009



99011
99012



99006

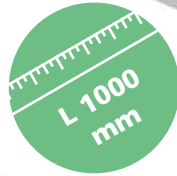

99007

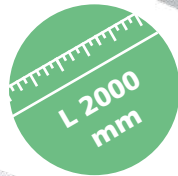

99008

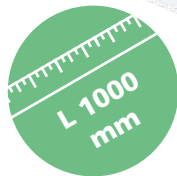

99006 SURFACE PROFILE 6

accessory; aluminium, aluminium / plastic, white
Zubehör; Alu, alu / Kunststoff, weiss
accessoire; aluminium, aluminium / plastique, blanc

L 1000, B 35, H 45



9 002759 990060

99007 SURFACE PROFILE 6

accessory; aluminium, aluminium / plastic, white
Zubehör; Alu, alu / Kunststoff, weiss
accessoire; aluminium, aluminium / plastique, blanc

L 2000, B 35, H 45



9 002759 990077

99008 SURFACE PROFILE 6

accessory; aluminium, white / plastic, white
Zubehör; Alu, weiss / Kunststoff, weiss
accessoire; aluminium, blanc / plastique, blanc

L 1000, B 35, H 45



9 002759 990084

INSTALLATION PROFILES LARGE

incl. end caps



99009 SURFACE PROFILE 6

accessory; aluminium, white / plastic, white
Zubehör; Alu, weiss / Kunststoff, weiss
accessoire; aluminium, blanc / plastique, blanc

L 2000, B 35, H 45



99011 SURFACE PROFILE 6

accessory; aluminium, black / plastic, white
Zubehör; Alu, schwarz / Kunststoff, weiss
accessoire; aluminium, noir / plastique, blanc

L 1000, B 35, H 45



99012 SURFACE PROFILE 6

accessory; aluminium, black / plastic, white
Zubehör; Alu, schwarz / Kunststoff, weiss
accessoire; aluminium, noir / plastique, blanc

L 2000, B 35, H 45



PROFILE CROSS-SECTION / Profilquerschnitt / section de profil

99006 99008 99011
99007 99009 99012

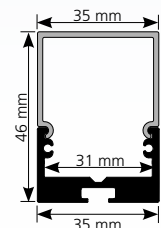



99495



99496



99497

99495 RECESSED PROFILE 4

accessory; aluminium, aluminium / plastic, white
Zubehör; Alu, alu / Kunststoff, weiss
accessoire; aluminium, aluminium / plastique, blanc

L 1000, B 62, H 14



9 002759 994952

99496 RECESSED PROFILE 4

accessory; aluminium, aluminium / plastic, white
Zubehör; Alu, alu / Kunststoff, weiss
accessoire; aluminium, aluminium / plastique, blanc

L 2000, B 62, H 14



9 002759 994969

99497 RECESSED PROFILE 4

accessory; aluminium, black / plastic, white
Zubehör; Alu, schwarz / Kunststoff, weiss
accessoire; aluminium, noir / plastique, blanc

L 1000, B 62, H 14



9 002759 994976

TILE PROFILE



99498



99498 RECESSED PROFILE 4

accessory; aluminium, black / plastic, white
 Zubehör; Alu, schwarz / Kunststoff, weiss
 accessoire; aluminium, noir / plastique, blanc

L 2000, B 62, H 14

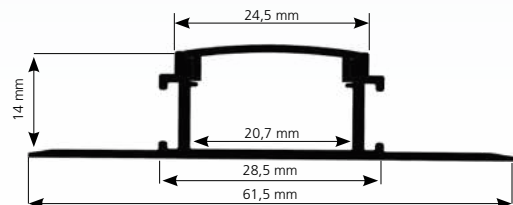

99495 99497
 99496 99498



99502 RECESSED PROFILE 4

accessory; aluminium, black / plastic, white
Zubehör; Alu, schwarz / Kunststoff, weiss
accessoire; aluminium, noir / plastique, blanc

L 1000, B 13, H 13



99503 RECESSED PROFILE 4

accessory; aluminium, black / plastic, white
Zubehör; Alu, schwarz / Kunststoff, weiss
accessoire; aluminium, noir / plastique, blanc

L 2000, B 13, H 13



99499 RECESSED PROFILE 4

accessory; aluminium, aluminium / plastic, white
Zubehör; Alu, alu / Kunststoff, weiss
accessoire; aluminium, aluminium / plastique, blanc

L 1000, B 13, H 13



TILE PROFILE FINISHING BOARD



99501



99501 RECESSED PROFILE 4

accessory; aluminium, aluminium / plastic, white
 Zubehör; Alu, alu / Kunststoff, weiss
 accessoire; aluminium, aluminium / plastique, blanc

L 2000, B 13, H 13

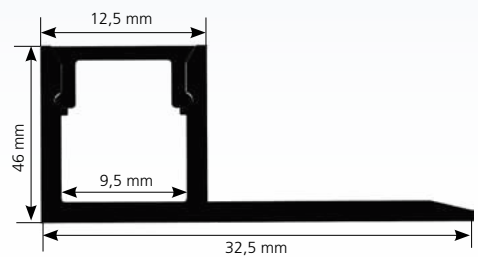

99499 99502
 99501 99503

EGLO WORLDWIDE

EGLO WELTWEIT / EGLO DANS LE MONDE



 **AUSTRIA**
EGLO LEUCHTEN GMBH

Heiligkreuz 22
6136 Pill
T: +43 5242 6996 0 | F: +43 5242 6996 972
info-austria@eglo.com

 **CHILE - SANTIAGO**
EGLO CHILE ILUMINACION LTDA.

Av. Américo Vespucio 1930
Conchalí - Santiago de Chile
T: +562 2 595 2222
info-chile@eglo.com

 **DENMARK**
EGLO DANMARK A/S

Agerbakken 20
8362 Hørning
T: +45 70 22 55 11 | F: +45 70 22 55 221
info-denmark@eglo.com

 **AUSTRALIA**
EGLO LIGHTING AUSTRALIA

5/339 Archerfield Road
4077 Richlands | Queensland
T: +61 7 3375 1413 | F: +61 7 3375 1412
info-australia@eglo.com

 **CHINA**
DONGGUAN EGLO LIGHTING COMMERCIAL
CO LTD

No.1 | Shangqiao Industrial Rd Shangqiao, Dongcheng
Dongguancity, Guanzhouprovince
T: +86 769 2203 3866 | F: +86 769 2203 6866
info-china@eglo.com

 **ESTONIA**
MOODNE VALGUSTUS AS

Rävalapst. 7
10143 Tallinn
T: +372 667 6670 | F: +372 631 3195
info-global@eglo.com

 **BELGIUM**
EGLO BELGIUM BV

Antwerpsesteenweg 247
2950 Kapellen
T: +32 3 250 60 80 | F: +32 3 219 80 67
info-belgium@eglo.com

 **COLOMBIA**
EGLO COLOMBIA ILUMINACION SAS

AUTOPISTA NORTE KM 19 COSTADO LOTE 30
bogotá - Chia
T: +57 (1) 744 2339
info-global@eglo.com

 **FINLAND**
EGLO FINLAND OY

Malmiraitti 17A
700 Helsinki
T: +358 20 7649 820 | F: +358 20 7649 821
info-finland@eglo.com

 **BOSNIA AND HERZEGOVINA**
EGLO RASVJETA BH D.O.O.

Ormanica bb
76250 Gradacac
T: +387 35 86 85 00 | F: +387 35 82 44 41
info-Bosnia-Herzegovina@eglo.com

 **COSTA RICA**
EGLO Costa Rica, Centro Comercial Calle
Reallocal #8

Guachipilinde Escazú de la sucursal del BAC
San Jose 800 metros al norte | San Jose
T: +506-2289-4690 | F: +506-2100-6384
info-costarica@eglo.com

 **FRANCE**
EGLO FRANCE LUMINAIRE SARL

Z.A. Jeune Bois | 2 Rue de la Martinique
68274 Wittenheim
T: +33 3 89 62 50 45 | F: +33 389 6250 49
info-france@eglo.com

 **BULGARIA**
EGLO BULGARIA EOOD

Main Road Burgas-Sofia | 5th kilometer | Building
KACHIKA
8000 Bourgas
T: +359 56 960 403 | F: +359 56 53 05 95
info-bulgaria@eglo.com

 **CROATIA**
EGLO RASVJETA D.O.O.

Jadranska avenija 9a
10000 Zagreb
T: +385 1 379 40 62 | F: +385 1 379 41 04
info-croatia@eglo.com

 **GERMANY**
EGLO LEUCHTEN HANDELS GMBH

Kleinbahnstr. 35
59759 Arnsberg
T: +49 2932 6269 0 | F: +49 2932 6269 39
info-germany@eglo.com

 **CANADA**
EGLO CANADA INC.

20700 Route Transcanadienne
H9X 4B7 Baie D'Ufré, Quebec
T: +1 514 457 5483 | F: +1 514 457 5487
info-canada@eglo.com

 **CZECH REPUBLIC**
EGLO CZ+SK s.r.o.

Náchodská 2479/63
193 00 Praha 9 Horní Pocernice
T: +420 281 924 163 | F: +420 281 925 205
info-czechrepublic@eglo.com

 **GREAT BRITAIN AND IRELAND**
EGLO UK LTD.

Unit 12 Cirrus Park, Lower Farm Road, Moulton Park
Industrial Estate, Northampton NN3 6UR
T: +44 1604 790 986 | F: +44 1604 670 282
info-greatbritain@eglo.com

**GREECE**

EGLO HELLAS A.E.

Sykias 2 and parodos dekeleias
13679 Acharnai
T: +30 21 0800 2363 | F: +30 210 240 07 29
info-greece@eglo.com

**HUNGARY - PRODUCTION AND LOGISTICS**

EGLO MAGYARORSZAG KFT.

Fő út. 155
3060 Paszto
T: + 36 32 560 050 | F: +36 32 560 040
info-hungary@eglo.com

**INDIA**

EGLO INDIA PRIVATE LIMITED

137, Arjun Nagar, Kotla Mubarakpur, Bhisma Pitamah Marg,
110003 Delhi
T: +91 999 961 0450
info-india@eglo.com

**ITALY**

EGLO ITALIANA S.R.L.

Via Giotto, 4
31021 Mogliano Veneto (TV)
T: +39 041 45 66 232 / -245/ -251 |
F: +39 041 45 74 066 / -071
info-italy@eglo.com

**KAZAKHSTAN**

EGLO KAZAKHSTAN LLP

Al-Farabi Avenue 7, Office 72, 14rd floor, Block 4A,
Nurly-Tau Business Center
50059 Almaty
T: +7 727 293 25 20 | M: +7 701 031 00 00
info-kazakhstan@eglo.com

**KOSOVO**

EGLO KOSOVA LLC

Lugisht e qytetit pn
20000 Prizren
T: +377 44 2166 87 | SHOP: +381 29 2442 84
info-kosovo@eglo.com

**LATVIA**

MOODNE VALGUSTUS AS

Rävalapst.7
10143 Tallinn
T: +370 652 49923 | T: +372 667 6670
info-latvia@eglo.com

**LITHUANIA**

MOODNE VALGUSTUS AS

Rävalapst.7
10143 Tallinn
T: +370 652 49923 | T: +372 667 6671
info-latvia@eglo.com

**MAGYARORSZÁG – ÉRTÉKESÍTÉS**

EGLO LUX KFT.

Fő út. 143/A
2120 Dunakeszi
T: +36 27 341 353 | F: +36 27 341 409
info-hungary@eglo.com

**MALAYSIA**

EGLO ASIA SDN BHD

No. 13, Jalan Pelukis U1/46B, Temasya 18, Glenmarie,
40150 Shah Alam, Selangor Darul Ehsan
T: +6011 1050 2336 | F: +603 5567 9415
info-malaysia@eglo.com

**MEXICO**

EGLO MÉXICO ILUMINACIÓN S DE RL DE CV

Prolongación Avenida López Mateos Sur N°3561,
Fraccionamiento Los Gavilanes
C.P. 45645 Tlajomulco de Zúñiga | Jalisco
T: +52 33 3687 20 95
info-mexico@eglo.com

**MIDDLE EAST**

EGLO LIGHTING MIDDLE EAST FZE

P.O. BOX 262073, LOB6, OFFICE G18
Jebel Ali, Dubai, UAE
T: +97 148810080 | F: +97 148810081
gulf@eglo.com

**MOROCCO - EGLO AFRICA**

EGLO MAGHREB LUMINAIRES SARL

219 Bd Med Zerktoouni. Suite: 67
20330 Casablanca
T: +212 522 98 80 25 / -05
info-global@eglo.com | info.africa@eglo.com

**THE NETHERLANDS**

EGLO VERLICHTING NEDERLAND B.V.

Innovatiepark 20
4906 AA Oosterhout (NBR)
T: +31 162 48 28 30
info.netherlands@eglo.com

**NORWAY**

MS Belysning AS

Heiaveien 4
1900 Fettsund
T: +47 63 888500 | F: +47 63 888501
info-norway@eglo.com

**PERU**

EGLO PERU S.A.C

Avda. Santa Cruz No. 458 Distrito de San Isidro
Provincia y Departamento Lima, San Isidro - Lima
T: +51 1 4212 158
egloperu@eglo.com

**POLAND**

EGLO POLSKA SP. Z O.O.

Ul. Dzwiekowa 2
02-857 Warszawa
T: +48 22 644 57 55 | F: +48 22 644 89 82
info-poland@eglo.com

**PORTUGAL**

EGLO PORTUGAL ILUMINAÇÃO, LDA

Rua Fonte Parada, 125
4595-434 Seroa-Paços de Ferreira
T: +351 255 890 000 | F: +351 255 892 346
info-portugal@eglo.com

**ROMANIA**

EGLO ROMANIA PRODEXIM SRL.

Str. Atomistilor nr. 1D
77125 Magurele - Ilfov
T: +40 314 250 902 | F: +40 314 250 899
info-romania@eglo.com

**RUSSIA**

EGLO LIGHTING LLC

Varshavskoe shosse 3 | Office 23
117105 Moscow
T: +7495 789 4311 | F: +7495 789 4312
info-russia@eglo.com

**SERBIA**

EGLO RASVETA DOO

Stefana Prvovenčanog 28
11000 Beograd
T: +381 11 3981 366 | F: +381 11 3981 389
info-serbia@eglo.com

**SLOVAKIA**

EGLO CZ+SK s.r.o

Náchodská 2479/63
193 00 Praha 9 Horní Počernice
T: +421 313 211 551 | F: +421 313 211 556
info-slovakia@eglo.com

**SLOVENIA**

EGLO RASVJETA D.O.O.

Jadranska avenija 9a
10000 Zagreb
T: +386 158 093 18
info-slovenia@eglo.com

**SPAIN**

EGLO ESPAÑA ILUMINACION S.L.

Avda. de Castilla 1 (Edf. Best Point) 2º-16A
28830 San Fernando de Henares, Madrid
T: +34 91 677 9044 | F: +34 91 677 0304
info-spain@eglo.com

**SWEDEN**

EGLO SVERIGE AB

Star Street 1
512 50 Svenljunga
T: +46 340 623 505 | F: +46 340 623 605
info-sweden@eglo.com

**SWITZERLAND**

EGLO SCHWEIZ AG

Seetalstraße 142
6032 Emmen
T: +41 41 268 69 59 | F: +41 41 268 69 58
info-switzerland@eglo.com

**TURKEY**

EGLO Aydınlatma ithalat ihracat Ltd. Şti.

Eyüp Sultan Mah. Sekmen Cad. No:18/2
34855 Sancaktepe / Istanbul Samandira
T: +90 216 311 09 -02 / -03 / -04 |
F: +90 216 311 09 / -05
info-turkey@eglo.com

**UKRAINE**

EGLO UKRAINE LTD

bulv. VatslavHavel 6/7A
3680 Kiev
T: +38 044 463 98 41 | F: +38 044 468 84 67
info-ukraina@eglo.com

**USA**

EGLO USA, INC.

3640 Royal South Parkway
30349 Atlanta, Georgia
T: +1 404 477 5601 | F: +1 404 393 7053
info-usa@eglo.com

HOW TO READ

ERKLÄRUNG
COMMENT LIRE

DIMENSIONS DIMENSIONEN DIMENSIONS

all dimensions in mm | alle Größen in mm | toutes dimensions en mm

L = length | Länge | longueur

B = width | Breite | largeur

H = height | Höhe | hauteur

Ø = diameter | Durchmesser | diamètre

A = projection length | Ausladung | amplitude

ET = installation depth | Einbautiefe | profondeur utile

Base = base dimensions | Sockelmaße | dimensions de base

Attention! The dimensions relate solely to the sizes of the luminaire. Any air spaces that would be relevant for a safe operating of the lamp were not considered.

Achtung! Die Größen beziehen sich nur auf die Abmessungen der Leuchte. Etwaige Lufträume, die für einen sicheren Betrieb der Leuchte notwendig sind, werden nicht berücksichtigt.

Attention! Les dimensions se réfèrent à la taille de la lampe seulement. Espacements éventuels, que seraient importants pour une opération de la lampe sans danger, n'ont pas été considérés.

BUTTONS BUTTONS BOUTONS

Bulb included | Leuchtmittel inkludiert | ampoules inclus



Recessed Luminaire | Einbauleuchte | luminaire encastrable



Surface Luminaire | Aufbauleuchte | luminaire en saillie



94406 PENETO
recessed light; steel, white
Einbauleuchte; Stahl, weiss
luminaire encastrable; acier, blanc

Ø 87, ET 115

400lm

94408 PENETO
recessed light; steel, satin nickel
Einbauleuchte; Stahl, nickel-matt
luminaire encastrable; acier, nickel mat

Ø 87, ET 115

400lm

94407 PENETO
recessed light; steel, chrome
Einbauleuchte; Stahl, chrom
luminaire encastrable; acier, chrome

Ø 87, ET 115

400lm

RECESSED LUMINAIRES - WITH BULBS
209

ARTICLE NUMBER
ARTIKELNUMMER
NUMÉRO D'ARTICLE



31682
LED



31683
LED



31689
LED

SPARE PARTS
ERSATZTEILE
PARTS DE REMPLACEMENT

If spare parts for product are available they are marked on the photograph with their corresponding article number.

Wenn zu einem Produkt Ersatzteile vorhanden sind, werden diese in der Abbildung mit der entsprechenden Artikelnummer markiert.

Si un produit a des parts de remplacement, elles sont marquées avec le numéro d'article dans la photo.

DESCRIPTION
BESCHREIBUNG
DESCRIPTION

The product description is composed as follows:
luminaire type; enclosure material, enclosure colour / glass or shade material, glass or shade colour

Die Produktbeschreibung setzt sich wie folgt zusammen:
Leuchtenart; Gehäusematerial, Gehäusefarbe / Schirm- bzw. Glasmaterial, Schirm- bzw. Glasfarbe

La description du produit est composée comme suit:
type de luminaire; matériel de boîtier, couleur de boîtier / matériel de verre ou abat-jour, couleur de verre ou abat-jour

31682 TEDO
recessed light; cast aluminium, white
Einbauleuchte; Aluguss, weiss
luminaire encastrable; fonte d'aluminium, blanc

31683 TEDO
recessed light; cast aluminium, white
Einbauleuchte; Aluguss, weiss
luminaire encastrable; fonte d'aluminium, blanc

31689 TEDO
recessed light; cast aluminium, satin nickel
Einbauleuchte; Aluguss, nickel-matt
luminaire encastrable; fonte d'aluminium, nickel mat



RECESSED LUMINAIRES - WITH BULBS
210

PICTOGRAMMES
PIKTOGRAMME
PICTOGRAMMES

Technical details are represented as pictograms. An overview over all pictograms can be found on the next pages.

Technische Details werden als Piktogramme dargestellt. Eine Übersicht über alle Piktogramme finden Sie auf den nächsten Seiten.

Les détails techniques sont représentés sous forme de pictogrammes. Vous trouverez un aperçu de tous les pictogrammes dans les pages suivantes.

SKETCHES
SKIZZEN
CROQUIS

The sketches state the most meaningful dimensions. If a product is adjustable by will, a turquoise arrow marks this function and only the maximum dimensions are indicated.

Die Bemaßung der Skizzen umfasst jeweils die aussagekräftigsten Größen. Bei verstellbaren Produkten kennzeichnet ein türkiser Pfeil diese Funktion und nur die maximalen Größen werden angegeben.



















Les dimensions des croquis comprennent les plus représentatives. Si un produit est réglable au choix, une flèche turquoise affiche cette fonction et rien que les dimensions maximales sont indiquées.

SERIES NAME
SERIENNAME
NOM DE LA SÉRIE



























































LEGEND

PICTOGRAM PIKTOGRAMME PICTOGRAMME

SOCKETS FASSUNGEN DOUILLES

 LED	 G4	 G53
 2G7	 G5	 GU5,3 / MR16
 2G11	 G9	 GU10
 2GX13	 G10Q	 GX53
 E14	 G13	 GY6,35
 E27	 G23	 R7s

BULBS LEUCHTMITTEL AMPOULES

 E14 / C35	 E27 / A60 Halogen	 E27 / E140 Filament
 E14 / C35f	 E27 / R63 Halogen	 E27 / PS160 Filament
 E14 / D45	 E27 / A60 LED	 E27 / T30 Filament
 E14 / C35f LED	 E27 / A60 Filament	 E27 / T32 Filament
 E14 / D45 Halogen	 E27 / A65 LED	 G4 / T9
 E14 / C35 Halogen	 E27 / A75 Filament	 G4 / LT9
 E14 / T22	 E27 / G45 LED	 G4 / LT14
 E14 / C35 Filament	 E27 / G45 Filament	 G9
 E14 / C37 Filament	 E27 / G80 Filament	 G9 LED
 E14 / C35f Filament	 E27 / G95	 GU10
 E14 / C37f Filament	 E27 / G95 Filament	 GU10 LED
 E14 / P45 LED	 E27 / G125	 GU10 SMD LED
 E14 / P45 Filament	 E27 / G95 LED	 GX53 / LF75
 E14 / P50	 E27 / G200 Filament	LED LED board / LED Platine / LED bord
 E14 / ST48 Filament	 E27 / R63 LED	 MR16
 E14 / ST64 Filament	 E27 / ST48 Filament	 MR16 LED
 E14 / T20 LED	 E27 / ST64 Filament	 R7s / 78mm
 E27 / A60	 E27 / B80 Filament	 R7s / 118mm
 E27 / G90	 E27 / BR150 Filament	 R7s / 78mm LED
 E27 / QR63	 E27 / DP165 Filament	 R7s / 118mm LED

LIGHT COLOUR & LUMEN
LICHTFARBE & LUMEN
COULEUR LUMINEUX & LUMEN

The colours of the LED are represented as pictogrammes (see below), their luminous flux directly beneath. The luminous flux is quoted in lumen and describes the amount of light generated by the LED. The higher the value, the brighter is the lamp. Lumens are LED boards and are the light measurement value in bulbs.

Die Farben der LED werden als Piktogramm (siehe unten) dargestellt, deren Lichtstrom direkt darunter. Der Lichtstrom wird in Lumen gemessen und gibt die erzeugte Lichtmenge der LED an. Je höher der Wert, desto heller das Produkt. Lichtstromangaben (Lumen) sind Platinen- bzw. Leuchtmittelwerte.

Les couleurs de LED ont représentés sous forme de pictogrammes, leur flux lumineux directement en dessous. L'unité de flux lumineux est le lumen et il mesure la quantité de lumière générée par les LED. Plus la valeur est élevée, plus la lampe est lumineuse. Les lumens sont l'unité de mesure de l'intensité lumineuse des ampoules et des panneaux led intégrés.

	RGB RGB RGB
	RGB + white RGB + weiß RGB + blanc
	RGB + warmwhite RGB + warmweiß RGB + blanc chaud
	RGB + coldwhite RGB + kaltweiß RGB + blanc froid
	RGB + neutralwhite RGB + neutralweiß RGB + blanc neutrale

	RGB + tunable white RGB + tunable white RGB + tunable white
	tunable white tunable white tunable white
	warm white warmweiß blanc chaud
	cold white kaltweiß blanc froid
	neutral white neutralweiß blanc neutre

SWITCHES & SENSORS
SCHALTER & SENSOREN
INTERRUPTEUR & CAPTEURS

	incl. cable & plug inkl. Kabel & Stecker câble & connecteur inclus
	internal dimmer eingebauter Dimmer variateur intégré
	button switch Druckknopf interrupteur de pression
	function switch Funktionsschalter interrupteur fonction
	rocker switch Wippschalter interrupteur à bascule
	pedal dimmer Trittdimmer variateur à pied

	pedal switch Trittschalter interrupteur à pied
	cable switch Kabelschalter interrupteur à câble
	incl. cable & plug transformer inkl. Kabel & Stecktransformator câble & transformateur à prise
	remote control Fernbedienung télécommande
	Day & Night Sensor Tag & Nacht Sensor sensor jour & nuit
	sensor Sensor sensor

	swedish plug Stecker Schweden connecteur swede
	"Touch me" ON/OFF "Touch me" EIN/AUS "Touch me" ON/OFF
	"Touch me" ON/OFF & dimm "Touch me" EIN/AUS & Dimmen "Touch me" ON/OFF & graduable
	pull switch Zugschalter interrupteur à bascule
	Timer - automatic on/off Zeitschaltuhr - automatisches Ein- & Ausschalten minuterie - peut être éteint et allumé automatiquement

FUNKTIONS & COMFORT
FUNKTIONEN & KOMFORT
FONCTIONS & COMFORT

	incl. battery inkl. Akku incl. pile
	incl. battery inkl. Batterie incl. pile
	battery specifications Batteriespezifikationen spécifications des piles
	beam angle Ausstrahlwinkel angle de rayonnement
	corner mount possible Eckmontage möglich montage en coin possible
	CRI Colour Rendering Index

	cutout (in mm) Ausschnitt (in mm) perçage du panneau (en mm)
	dimmable dimmbar mit externen Dimmer graduable
	not dimmable nicht dimmbar ne pas graduable
	Can be operated via control unit Bedienbar über Steuergerät Peut être commandé par une unité de contrôle
	replaceable LED austauschbare LED LED remplaçables
	loadable in kg belastbar in kg chargeable en kg

	packaging / delivery unit Verpackungs- / Liefereinheit unité d'emballage / de livraison
	shortable kürzbar réductible
	Voltage Volt Voltage
	Watt
	USB connection USB-Anschluss Connexion USB
	Qi-Charger

PROTECTION CLASS
SCHUTZKLASSE
CLASSE DE PROTECTION

The protection class indicates to what extent the lamp is protected against electric shock. All lamps in this catalogue are at least protected with the protection class 1 - a higher class is specified in the information box of the respective lamp.

Die Schutzklasse gibt an, inwiefern ein Produkt gegen einen elektrischen Schlag gesichert ist. Alle Leuchten in diesem Katalog sind mit mindestens Schutzklasse 1 gesichert, bei höheren Klassen wird das Symbol im Infokasten der Leuchte angegeben.

La classe de protection indique, dans quelle mesure la lampe est protégée contre les chocs électriques. Tous les lampes dans ce catalogue sont protégées au moins avec la classe 1 - une classe plus élevée est indiquée dans l'information de la lampe.

	protection class 1: protective earthing Schutzklasse 1: Schutzerdung classe de protection 1: prise de terre
--	---

	protection class 2: protective insulation Schutzklasse 2: Schutzisolation classe de protection 2: double isolation ou renforcée
--	---

	protection class 3: protective low voltage Schutzklasse 3: Schutzkleinspannung classe de protection 3: très basse tension de sécurité
--	---

PROTECTION RATING
SCHUTZGRAD
INDICE DE PROTECTION

The protection rating ensures the operational safety of luminaires. The first number specifies the extent of the protection against the ingress of foreign bodies; the second number identifies the humidity protection grade. All luminaires in this catalogue are at least protected with the rating IP20 - a higher rating is specified in the information box of the luminaire.

Der Schutzgrad gewährleistet die Betriebssicherheit von Leuchten. Die erste Ziffer des IP Grades beschreibt den Schutzzumfang gegen das Eindringen von Fremdkörpern, die zweite Ziffer informiert über den Grad des Feuchtigkeitsschutzes. Alle Leuchten in diesem Katalog sind mit mindestens Schutzgrad IP20 gesichert, bei höheren Graden wird das Symbol im Infokasten der Leuchte angegeben.

L'indice de protection assure la sécurité opérationnelle des luminaires. Le premier chiffre indique à quel point la protection est efficace contre l'insertion de corps étrangers; le second chiffre indique quant à lui le degré de protection par rapport à l'humidité. Tous les luminaires dans ce catalogue sont protégés au moins avec l'indice IP20 - un indice plus élevé est indiqué dans l'information d'article.

	IP33
	IP44

	IP54
	IP65

	IP67
--	------

REGISTER

ARTICLE NUMBER

ARTIKELNUMMER

NUMÉROS D'ARTICLE

NUMBER NUMMER NUMÉRO	PAGE SEITE PAGE	NUMBER NUMMER NUMÉRO	PAGE SEITE PAGE	NUMBER NUMMER NUMÉRO	PAGE SEITE PAGE	NUMBER NUMMER NUMÉRO	PAGE SEITE PAGE	NUMBER NUMMER NUMÉRO	PAGE SEITE PAGE	NUMBER NUMMER NUMÉRO	PAGE SEITE PAGE	NUMBER NUMMER NUMÉRO	PAGE SEITE PAGE
30891	239	900099	28	95855	115	98209	53	98802	191	98911	270	98962	289
30892	238	900101	28	95856	115	98212	57	98803	191	98912	270	98963	290
30893	239	900102	28	95857	117	98238	130	98804	196	98913	270	98964	290
30894	239	900103	34	95858	117	98239	131	98805	197	98914	271	98965	290
31682	210	900104	34	95859	117	98241	130	98806	197	98915	271	98966	291
31683	210	900105	32	95887	134	98242	131	98807	197	98916	271	98967	292
31688	211	900106	32	95888	134	98243	122	98808	192	98917	272	98968	292
31689	210	900107	32	95889	134	98244	122	98809	192	98918	272	98971	292
32811	89	900108	38	95932	135	98246	123	98811	198	98919	272	98972	293
32812	88	900109	39	95962	135	98292	57	98812	198	98921	273	98974	293
32813	89	900111	30	96151	71	98293	57	98813	198	98922	273	98975	293
32896	120	900112	30	96152	70	98295	58	98814	200	98923	273	98977	294
33107	96	900113	30	96153	70	98296	58	98815	200	98924	274	98978	294
33108	96	900114	36	96154	70	98297	54	98816	200	98925	274	98979	294
33199	52	900115	36	96791	252	98301	126	98817	201	98926	274	98981	295
61355	72	91355	253	96792	252	98302	128	98818	201	98927	275	98982	295
61358	72	94235	207	96794	252	98303	126	98819	201	98928	275	98983	295
61359	73	94236	207	96901	136	98304	128	98821	190	98929	275	98984	296
61361	73	94237	207	96902	136	98305	127	98822	190	98931	276	98985	296
61489	72	94239	208	97029	265	98306	129	98823	190	98932	276	98986	296
900044	24	94406	209	97079	174	98307	127	98824	194	98933	276	98987	297
900045	24	94407	209	97262	240	98308	129	98825	194	98934	278	98988	297
900046	24	94408	209	97263	241	98418	90	98826	194	98935	278	98989	297
900047	25	94496	250	97264	242	98419	90	98827	195	98936	278	98991	298
900048	25	94497	250	97265	242	98471	124	98828	195	98937	277	98992	298
900049	26	94499	250	97266	241	98472	124	98829	195	98938	277	98993	298
900051	26	94501	248	97267	241	98473	124	98842	29	98939	277	98994	299
900052	26	94502	248	97268	243	98474	125	98843	35	98941	280	98995	299
900053	27	94503	249	97269	242	98475	78	98844	31	98942	280	98996	299
900054	18	94504	248	97271	240	98476	78	98845	36	98943	280	98997	300
900055	18	95357	212	97279	240	98477	78	98846	33	98944	281	98998	300
900056	18	95359	213	97501	94	98478	79	98847	38	98945	282	98999	303
900057	22	95817	132	97502	94	98479	79	98849	34	98946	282	99001	303
900058	22	95818	132	97503	94	98485	95	98852	37	98947	282	99002	302
900059	22	95819	132	97593	172	98521	170	98854	38	98948	283	99003	302
900061	23	95821	133	97594	172	98571	260	98865	166	98949	284	99004	303
900062	23	95822	133	97927	264	98572	260	98866	166	98951	284	99005	302
900086	40	95823	133	97928	264	98573	263	98867	166	98952	284	99006	304
900087	41	95843	118	98025	89	98574	263	98868	167	98953	285	99007	304
900088	40	95844	118	98129	88	98607	122	98869	167	98954	286	99008	304
900089	40	95846	118	98201	54	98609	126	98871	167	98955	286	99009	305
900091	42	95848	114	98203	54	98611	128	98901	80	98956	286	99011	305
900092	43	95851	116	98205	55	98637	206	98902	80	98957	287	99012	305
900093	42	95852	116	98206	55	98639	206	98903	80	98958	288	99038	66
900094	42	95853	116	98207	52	98641	212	98904	81	98959	288	99039	66
900095	27	95854	115	98208	52	98801	191	98905	81	98961	288	99061	204

NUMBER NUMMER NUMÉRO	PAGE SEITE PAGE	NUMBER NUMMER NUMÉRO	PAGE SEITE PAGE	NUMBER NUMMER NUMÉRO	PAGE SEITE PAGE	NUMBER NUMMER NUMÉRO	PAGE SEITE PAGE	NUMBER NUMMER NUMÉRO	PAGE SEITE PAGE
99062	204	99191	159	99253	229	99497	306	99755	186
99065	254	99192	159	99254	229	99498	307	99756	187
99066	254	99193	159	99255	230	99499	308	99757	184
99099	15	99202	160	99256	230	99501	309	99758	185
99131	140	99203	160	99257	230	99502	308	99759	185
99132	140	99204	162	99258	232	99503	308	99761	184
99133	140	99205	162	99259	232	99548	20	99762	187
99134	141	99206	160	99263	232	99549	20	99763	187
99135	141	99207	161	99264	233	99639	20	99833	84
99136	142	99208	162	99265	234	99643	137	99834	85
99137	142	99209	163	99266	234	99644	137	99835	85
99138	142	99211	164	99267	234	99669	17	99836	85
99139	143	99212	164	99268	236	99671	17	99841	67
99141	143	99213	164	99269	236	99672	17	99842	67
99142	144	99214	165	99271	236	99684	44	99843	82
99143	144	99215	217	99281	256	99685	45	99844	83
99144	144	99216	217	99282	256	99686	44	99845	83
99145	145	99217	217	99283	256	99687	44	99846	83
99146	145	99218	218	99284	257	99716	260		
99147	146	99219	218	99337	246	99717	261		
99148	146	99221	218	99338	246	99718	261		
99149	146	99222	219	99421	100	99719	261		
99151	147	99223	219	99422	100	99721	262		
99152	148	99224	219	99423	101	99722	262		
99153	148	99225	220	99424	101	99723	262		
99154	148	99226	220	99425	102	99724	264		
99155	149	99227	220	99426	102	99726	246		
99156	150	99228	221	99427	103	99727	247		
99157	150	99229	221	99428	103	99728	74		
99158	150	99232	221	99431	104	99729	74		
99159	151	99233	222	99432	104	99734	180		
99162	152	99234	222	99433	105	99735	180		
99163	152	99235	222	99434	105	99736	181		
99164	152	99236	224	99435	106	99737	180		
99167	153	99237	224	99436	106	99738	181		
99168	153	99238	224	99437	106	99739	181		
99169	153	99239	225	99471	107	99742	182		
99178	154	99241	225	99472	107	99743	182		
99179	154	99242	225	99473	107	99744	183		
99181	154	99243	226	99474	108	99745	182		
99183	155	99244	226	99475	108	99746	183		
99184	155	99245	226	99476	108	99747	183		
99185	155	99246	228	99493	130	99749	186		
99187	157	99247	228	99494	131	99751	186		
99188	157	99248	228	99495	306	99753	184		
99189	157	99252	229	99496	306	99754	185		

REGISTER

SERIES NAMES
SERIENNAMEN
NOME DE PRODUITS

NAME NAME NOM	PAGE SEITE PAGE	NAME NAME NOM	PAGE SEITE PAGE	NAME NAME NOM	PAGE SEITE PAGE
ACCESS REMOTE	52	RECESSED PROFILE 3	302-303	TB CORTENOVA	184-185
ARETIO	206	RECESSED PROFILE 4	306-309	TB MIDDLE FEEDER	181,183
CHANGO	174	REMOTE 2.0	15	TB NEWTOWN	184
CORNER PROFILE 1	280-285	RONZANO 1	170	TB SERAS	186
CORNER PROFILE 2	286-291	ROVITO-Z	40-43	TB SET	187
CRESPILLO	246-247	SALABATE	130-131	TB SPOTLIGHT	186-187
FERREROS	252	SALICETO	122-129	TB TRACK L	180,182
FIOBBO	172	SALICETO-Z	17	TB TRACK S	180,182
FLEXIBLE STRIPE	260-264	SALOBRENA 1	70-73,88-89	TEDO	210-211
FUEVA 1	240-243	SALOBRENA-A	54-55	TEDO 1	212-213
FUEVA 5	140-155,157, 159-165,217-222, 224-226,228-230, 232-234,236, 238-239	SALOBRENA-F	100-105	TP BLIND COVER L	195
FUEVA FLEX	166-167	SALOBRENA-M	90	TP BLIND COVER S	194
FUEVA-A	57	SALOBRENA-RGBW	96	TP CANOPY	197
FUEVA-Z	28-39	SALOBRENA-Z	24-27	TP CUBE CONNECTOR	191
GRIMASOLA	256-257	SALUZZO	204,254	TP DOWNLIGHT	200
HERRORA-Z	20	SARSINA	94-95	TP LIGHT INSERT L	192
LAZARAS	67	SARSINA-A	52-53	TP LIGHT INSERT S	192
LED STRIPE-Z	44-45	SARTIANO	120	TP PENDANT LIGHT	198
LED STRIPES-FLEX	264	SAVATARILA	66	TP SPOTLIGHT	201
LED-STRIFE-A	58	SURFACE PROFILE 1	270-272	TP SUSPENSION	196
LOKE 1	253	SURFACE PROFILE 2	273-275	TP TRACK	190
MECINOS	137	SURFACE PROFILE 3	276-278	TURCONA	78-81
PENETO	207-209	SURFACE PROFILE 4	292-293	TURCONA-B	82-83
PIDIO	265	SURFACE PROFILE 5	300	TURCONA-CCT	84-85
PIGLIONASSO	106-108	SURFACE PROFILE 6	304-305	TURCONA-Z	18,22-23
PINEDA	114-118,132-134	TB ADAPTER	181,183	URTEBIETA	74
PINEDA 1	135	TB CASIBARE	184	ZARATE	136
POLASSO	248-250	TB CONNECTOR	180,182		
RECESSED PROFILE 1	294-296	TB CORNER CONNECT	181,183		
RECESSED PROFILE 2	297-299	TB CORTADERAS	185		



All previous catalogues and price lists are no longer valid with the issue of this catalogue. Errors, misprints, model and price changes and technical modifications are reserved. We deliver based on our terms of delivery and payment. Our products comply with the European light norm EN60598. Products with the ENEC test mark are conforming to the guide line 2006/95/EG. Products with additional safety remarks (e.g protection class, IP) are identified within the product family with the relevant symbol and number. The content of this catalogue is protected under copyright law for EGLO Leuchten GmbH. All rights reserved. Our specific written consent must be obtained before using any illustrations and texts. The pictures are 4C prints and may differ from the original.

The product pictures and ambiances in this catalogue can deviate from reality, and they do not necessarily concur with the usual application of the product. EGLO does not assume liability for the correctness, completeness or the application depiction of the products and/or the product information.

Design, layout and composition: EGLO GmbH, A-6136 Pöll - AUSTRIA
Print: Gutenberg-Werbering Gesellschaft m.b.H., 4020 Linz - AUSTRIA
Pictures: EGLO, Adobe Stock, istockphoto.com

Mit diesem Katalog verlieren alle vorhergehenden Kataloge und Preislisten ihre Gültigkeit. Irrtümer, Druckfehler, Modell- und Preisänderungen sowie technische Änderungen vorbehalten. Wir liefern zu unseren Liefer- und Zahlungsbedingungen. Unsere Produkte entsprechen der europäischen Leuchtnorm EN 60598. Produkte mit dem ENEC Prüfzeichen sind konform mit der Richtlinie 2006/95/EG. Produkte mit weiteren Sicherheitshinweisen (zB. Schutzklasse, IP) sind mit Symbol und Zahl bei der Produktfamilie ausgezeichnet. Der Inhalt dieses Kataloges ist für die EGLO Leuchten GmbH urheberrechtlich geschützt. Alle Rechte sind vorbehalten. Bilder und Texte dürfen nicht ohne vorherige ausdrückliche, schriftliche Genehmigung verwendet werden. Die Abbildungen sind 4C Drucke und können vom Original abweichen.

Die Katalogbilder und die gezeigten Darstellungen der Produkte können von der Wirklichkeit abweichen und nicht den üblichen Produktanwendungen entsprechen. EGLO übernimmt keine Haftung für die Richtigkeit, Vollständigkeit und Anwendungsdarstellung der Produkte und Produktinformationen.

Gestaltung, Layout und Satz: EGLO GmbH, A-6136 Pöll - AUSTRIA
Druck: Gutenberg-Werbering Gesellschaft m.b.H., 4020 Linz - AUSTRIA
Bilder: EGLO, Adobe Stock, istockphoto.com

Le présent catalogue remplace tous les catalogues et tarifs précédents. Sous réserve d'erreurs, de fautes d'impression, de modification des modèles et de changement de prix et de technique. Nous livrons sur la base de nos conditions de livraison et de paiement. Nos produits sont conformes aux normes européennes EN 60598 et portent le marquage CE. Les produits portant la marque ENEC sont conformes à la Directive 2006/95/EG. Les produits portant d'autres indications de sécurité (par exemple classe de protection, IP) sont identifiés par le symbole et le nombre correspondants dans la famille de produits.

Le contenu du présent catalogue est protégé pour la société EGLO Leuchten GmbH par un copyright. Tous droits réservés. Toute reproduction d'images et du texte est interdite sans autorisation explicite par écrit préalable. Les images sont imprimées en 4C et peuvent différer de l'original.

Les images des produits et les ambiances dans le catalogue peuvent dévier de la réalité et ne sont pas nécessairement en ligne avec l'usage habituel du produit. EGLO n'engage pas sa responsabilité sur la justesse des images et sur les informations relatives à l'usage pouvant être fait des produits.

Conception, maquette et composition: EGLO GmbH, A-6136 Pöll - AUSTRIA
Presse: Gutenberg-Werbering Gesellschaft m.b.H., 4020 Linz - AUSTRIA
Images: EGLO, Adobe Stock, istockphoto.com

06-2021



EGLO
my light | my style

EGLO Leuchten GmbH
Heiligkreuz 22
A-6136 Pill
Austria
Tel. +43 (0) 5242 6996
Fax +43 (0) 5242 6996-972
info@eglo.com
www.eglo.com

KATTL21

my light | my style