



K U T E K

CLASSIC

P R A C O W N I A L A M P

KUTEK.COM.PL



K U T E K

CLASSIC



P R A C O W N I A L A M P

KUTEK.COM.PL



Założycielami firmy Kutek są Maciej i Elżbieta Kutek, którzy tworzą niesamowite lampy z mosiądzu od ponad 30 lat. Pracownia założona z marzeń o tworzeniu piękna jest wyjątkowym miejscem w Polsce, gdzie można dotknąć dwóch tradycji - Empire i Modern Designu.

Pracownia posiada nowoczesny park maszynowy, ale jej największym atutem są doświadczeni pracownicy i ich umiejętności zdobywane przez długie lata pracy, wyuczone pod okiem najznakomitszych mistrzów. Jako jedyna pracownia w Polsce tworząca lampy z mosiądzu utrzymuje najwyższy poziom wykonania oświetlenia doceniany przez wszystkich na całym świecie.

Stylowe wnętrza z lampami z pracowni Kutek pozwolą Państwu zanurzyć się w zmysłowej elegancji i poczuć magię wyjątkowych rzeczy.





PRACOWNIA LAMP

KUTEK.COM.PL



K U T E K
CLASSIC

The founders of the Kutek company are Maciej and Elzbieta, who have been creating amazing lamps from brass for over 30 years. The workshop, founded from dreams of creating beauty, is a unique place in Poland, Where you can touch two traditions - Empire and Modern Design

The workshop has modern mashinery but its greatest strength is its experienced staff and their skills acquired over many years of work, learned under the guidance of most distinguished masters. As the only workshop in Poland creating lamps from brass it maintains the highest level of lighting appreciated by everyone all over the world.

Stylish interiors with lamps from Kutek workshop will let you immerse in sensual elegance and feel the magic of exeptional things



P R A C O W N I A L A M P



PRACOWNIA LAMP

KUTEK.COM.PL



Основателями компании Kutek являются Maciej i Elżbieta Kutek, которые уже более 30 лет создают удивительные латунные лампы. Мастерская, основанная на мечтах о создании красоты, является уникальным местом в Польше, где можно прикоснуться к двум традициям – Empire и Modern Design.

Мастерская имеет современный машинный парк, однако ее наибольшей силой являются опытные работники и их навыки, приобретенные за долгие годы работы, освоенные под зорким оком лучших мастеров. Kutek является единственной мастерской в Польше, которая производит лампы из латуни, поддерживает высочайший уровень исполнения световых изделий, которые ценят все во всем мире.

Стильные интерьеры с лампами от мастерской Kutek позволят вам погрузиться в чувственную элегантность и ощутить волшебство уникальных вещей.





K U T E K
CLASSIC

ARE - PL - 8 (N) 300
ARE - PL - 8 (P) 300
ARE - PL - 8 (Z) 300
ARE - PL - 8 (BN) 300
ARE - PL - 8 (ZM) 300

± 760 mm ↔ 300 mm
💡 8 x MAX 40W E 14

ARE - PL - 8 (P) 400
ARE - PL - 8 (Z) 400
ARE - PL - 8 (N) 400
ARE - PL - 8 (BN) 400
ARE - PL - 8 (ZM) 400

± 950 mm ↔ 400 mm
💡 8 x MAX 40W E 14



(P) - PATYNA - PATINA - ПАТИНА
 (Z) - ZŁOTO - GOLD - ЗОЛОТО
 (N) - NIKIEL MATOWY - ANCIENT NICKEL - АНТИЧНЫЙ НИКЕЛЬ
 (BN) - BŁYSZCZĄCY NIKIEL - SHINY NICKEL - БЛИСТЯЩИЙ НИКЕЛЬ
 (ZM) - ZŁOTO MATOWE - MATT GOLD - МАТОВОЕ ЗОЛОТО



ARE-PL-8 (P) 400



ARE-PL-8 (N) 300

AREZZO



K U T E K
CLASSIC

AVE - PL - 6 (N/A)
AVE - PL - 6 (P/A)
AVE - PL - 6 (Z/A)
AVE - PL - 6 (BN/A)
AVE - PL - 6 (ZM/A)

± 370 mm ↔ 860 mm
💡 6 x MAX 40W E 14

AVE - LG - 1 (Z/A)
AVE - LG - 1 (P/A)
AVE - LG - 1 (N/A)
AVE - LG - 1 (BN/A)
AVE - LG - 1 (ZM/A)

± 540 mm ↔ 300 mm
💡 1 x MAX 60W E 27

AVE - K - 1 (N/A)
AVE - K - 1 (P/A)
AVE - K - 1 (Z/A)
AVE - K - 1 (BN/A)
AVE - K - 1 (ZM/A)

± 300 mm ↔ 180 mm ↔ 220
💡 1 x MAX 40W E 14

AVE - ZW - 6 (Z/A)
AVE - ZW - 6 (P/A)
AVE - ZW - 6 (N/A)
AVE - ZW - 6 (BN/A)
AVE - ZW - 6 (ZM/A)

± 700 mm ↔ 860 mm
💡 6 x MAX 40W E 14

AVE - LS - 1 (P/A)
AVE - LS - 1 (Z/A)
AVE - LS - 1 (N/A)
AVE - LS - 1 (BN/A)
AVE - LS - 1 (ZM/A)

± 1770 mm ↔ 450 mm
💡 1 x MAX 60W E 27

 (P) - PATYNA - PATINA - ПАТИНА
 (Z) - ZŁOTO - GOLD - ЗОЛОТО
 (N) - NIKIEL MATOWY - ANCIENT NICKEL - АНТИЧНЫЙ НИКЕЛЬ
 (BN) - BŁYSZCZĄCY NIKIEL - SHINY NICKEL - БЛИСТЯЩИЙ НИКЕЛЬ
 (ZM) - ZŁOTO MATOWE - MATT GOLD - МАТОВОЕ ЗЛОТО



AVE-LS-1(P/A)



AVE-ZW-6 (Z/A)



AVE-PL-6 (N/A)



AVE-PL-6 (N/A)



AVE-LG-1 (Z/A)

AVERNO



AVE-K-1 (N/A)



 K U T E K
 CLASSIC

BAC - PLM - 3 (P) 300

BAC - PLM - 3 (N) 300

BAC - PLM - 3 (ZM) 300

± 200 mm ↔ 300 mm

💡 3 x MAX 60W E 27



BAC - PLM - 4 (P) 400

BAC - PLM - 4 (N) 400

BAC - PLM - 4 (ZM) 400

± 250 mm ↔ 400 mm

💡 4 x MAX 60W E 27



 (P) - ПАТУНА - PATINA - ПАТИНА
 (N) - НИКЕЛ МАТОВЫЙ - ANCIENT NICKEL - АНТИЧНЫЙ НИКЕЛЬ
 (ZM) - ЗОЛОТО МАТОВОЕ - MATT GOLD - МАТОВОЕ ЗОЛОТО



BAC-PLM-3 (P) 300



BAC-PLM-4 (P) 400

BACCARA



K U T E K
 CLASSIC

BAR - ZW - 8 + 4 (BN)

BAR - ZW - 8 + 4 (P)

BAR - ZW - 8 + 4 (Z)

BAR - ZW - 8 + 4 (N)

BAR - ZW - 8 + 4 (ZM)

± 1000 mm ↔ 880 mm

💡 24 x MAX 5W G 9

BAR - K - 2 (Z)

BAR - K - 2 (P)

BAR - K - 2 (N)

BAR - K - 2 (BN)

BAR - K - 2 (ZM)

± 360 mm ↔ 120 mm ↔ 140 mm

💡 2 x MAX 5W G 9

BAR - LS - 3 (ZM)

BAR - LS - 3 (Z)

BAR - LS - 3 (N)

BAR - LS - 3 (P)

BAR - LS - 3 (BN)

± 1750 mm ↔ 330 mm

💡 6 x MAX 5W G 9

BAR - LS - 1 (ZM)

BAR - LS - 1 (N)

BAR - LS - 1 (P)

BAR - LS - 1 (Z)

BAR - LS - 1 (BN)

± 1600 mm ↔ 280 mm

💡 1 x MAX 5W G 9

BAR - ZW - 8 (ZM)

BAR - ZW - 8 (P)

BAR - ZW - 8 (N)

BAR - ZW - 8 (Z)

BAR - ZW - 8 (BN)

± 700 mm ↔ 880 mm

💡 16 x MAX 5W G 9

BAR - ZW - 6 (Z)

BAR - ZW - 6 (P)

BAR - ZW - 6 (N)

BAR - ZW - 6 (BN)

BAR - ZW - 6 (ZM)

± 700 mm ↔ 850 mm

💡 12 x MAX 5W G 9

BAR - ZW - 3 (Z)

BAR - ZW - 3 (P)

BAR - ZW - 3 (N)

BAR - ZW - 3 (BN)

BAR - ZW - 3 (ZM)

± 700 mm ↔ 500 mm

💡 6 x MAX 5W G 9

BAR - LG - 1 (P)

BAR - LG - 1 (N)

BAR - LG - 1 (Z)

BAR - LG - 1 (BN)

BAR - LG - 1 (ZM)

± 510 mm ↔ 130 mm

💡 1 x MAX 5W G 9

- (P) - PATYNA - PATINA - ПАТИНА
- (Z) - ZŁOTO - GOLD - ЗОЛОТО
- (N) - NIKIEL MATOWY - ANCIENT NICKEL - АНТИЧНЫЙ НИКЕЛЬ
- (BN) - BŁYSZCZĄCY NIKIEL - SHINY NICKEL - БЛИСТЯЩИЙ НИКЕЛЬ
- (ZM) - ZŁOTO MATOWE - MATT GOLD - МАТОВОЕ ЗЛОТО



BAR-LS-1 (ZM)



BAR-LS-3 (ZM)



BAR-ZW-8 (ZM)



BAR-ZW-3 (Z)



BAR-ZW-6 (Z)



BAR-ZW-8+4 (BN)



BAR-LG-1 (P)



BAR-K-2 (Z)

BARI



K U T E K
CLASSIC

BEL - PL - 3 (P) 470 CR
BEL - PL - 3 (N) 470 CR
BEL - PL - 3 (Z) 470 CR
BEL - PL - 3 (BN) 470 CR
BEL - PL - 3 (ZM) 470 CR

↓ 200 mm ↔ 470 mm
💡 3 x MAX 60W E 27

BEL - PL - 3 (N) 470 CR
BEL - PL - 3 (P) 470 CR
BEL - PL - 3 (Z) 470 CR
BEL - PL - 3 (BN) 470 CR
BEL - PL - 3 (ZM) 470 CR

↓ 200 mm ↔ 470 mm
💡 3 x MAX 60W E 27

BEL - PL - 3 (Z) CR
BEL - PL - 3 (P) CR
BEL - PL - 3 (N) CR
BEL - PL - 3 (BN) CR
BEL - PL - 3 (ZM) CR

↓ 200 mm ↔ 600 mm
💡 3 x MAX 60W E 27

BEL - PL - 3 (P) OZ CR
BEL - PL - 3 (N) OZ CR
BEL - PL - 3 (Z) OZ CR
BEL - PL - 3 (BN) OZ CR
BEL - PL - 3 (ZM) OZ CR

↓ 200 mm ↔ 600 mm
💡 3 x MAX 60W E 27

BEL - PL - 3 (P) 470
BEL - PL - 3 (N) 470
BEL - PL - 3 (Z) 470
BEL - PL - 3 (ZM) 470
BEL - PL - 3 (BN) 470

↓ 200 mm ↔ 470 mm
💡 3 x MAX 60W E 27

BEL - PL - 3 (P) CR
BEL - PL - 3 (N) CR
BEL - PL - 3 (Z) CR
BEL - PL - 3 (BN) CR
BEL - PL - 3 (ZM) CR

↓ 200 mm ↔ 600 mm
💡 3 x MAX 60W E 27

- (P) - PATYNA - PATINA - ПАТИНА
- (Z) - ZŁOTO - GOLD - ЗОЛОТО
- (N) - NIKIEL MATOWY - ANCIENT NICKEL - АНТИЧНЫЙ НИКЕЛЬ
- (BN) - BŁYSZCZĄCY NIKIEL - SHINY NICKEL - БЛИСТАЩИЙ НИКЕЛЬ
- (ZM) - ZŁOTO MATOWE - MATT GOLD - МАТОВОЕ ЗОЛОТО



BEL-PL-3(P) 470 CR



BEL-PL-3(N) 470 CR



BEL-PL-3(P) 470



BEL-PL-3(Z) CR



BEL-PL-3(P) CR



BEL-PL-3(P) OZ CR

BELLAGIO



K U T E K
 CLASSIC

BEL - PL - 3 (P) 470 OZ CR
 BEL - PL - 3 (N) 470 OZ CR
 BEL - PL - 3 (Z) 470 OZ CR
 BEL - PL - 3 (BN) 470 OZ CR
 BEL - PL - 3 (ZM) 470 OZ CR

↓ 200 mm ↔ 470 mm
 ⚡ 3 x MAX 60W E 27

BEL - PL - 5 (P) CR OZ
 BEL - PL - 5 (N) CR OZ
 BEL - PL - 5 (Z) CR OZ
 BEL - PL - 5 (BN) CR OZ
 BEL - PL - 5 (ZM) CR OZ

↓ 340 mm ↔ 600 mm
 ⚡ 5 x MAX 60W E 27

BEL - PL - 3 (P)
 BEL - PL - 3 (N)
 BEL - PL - 3 (Z)
 BEL - PL - 3 (BN)
 BEL - PL - 3 (ZM)

↓ 200 mm ↔ 600 mm
 ⚡ 3 x MAX 60W E 27

BEL - PL - 5 (P) CR
 BEL - PL - 5 (N) CR
 BEL - PL - 5 (Z) CR
 BEL - PL - 5 (ZM) CR
 BEL - PL - 5 (BN) CR

↓ 340 mm ↔ 600 mm
 ⚡ 5 x MAX 60W E 27

 (P) - PATYNA - PATINA - ПАТИНА
 (Z) - ZŁOTO - GOLD - ЗОЛОТО
 (N) - NIKIEL MATOWY - ANCIENT NICKEL - АНТИЧНЫЙ НИКЕЛЬ
 (BN) - BEYSZCZĄCY NIKIEL - SHINY NICKEL - БЛИСТАЩИЙ НИКЕЛЬ
 (ZM) - ZŁOTO MATOWE - MATT GOLD - МАТОВОЕ ЗЛОТО



BEL-PL-3(P) 470 OZ CR



BEL-PL-5(P) CR OZ



BEL-PL-3(P)



BEL-PL-5(P) CR

BELLAGIO



K U T E K
 CLASSIC

BEL - MOD - PL - 3 (N) CR
 BEL - MOD - PL - 3 (P) CR
 BEL - MOD - PL - 3 (Z) CR
 BEL - MOD - PL - 3 (ZM) CR
 BEL - MOD - PL - 3 (BN) CR

± 140 mm ↔ 500 mm
 3 x MAX 60W E 27



BEL - MOD - PL - 3 (N)
 BEL - MOD - PL - 3 (P)
 BEL - MOD - PL - 3 (Z)
 BEL - MOD - PL - 3 (ZM)
 BEL - MOD - PL - 3 (BN)

± 140 mm ↔ 500 mm
 3 x MAX 60W E 27



-  (P) - PATYNA - PATINA - ПАТИНА
-  (Z) - ZŁOTO - GOLD - ЗОЛОТО
-  (N) - NIKIEL MATOWY - ANCIENT NICKEL - АНТИЧНЫЙ НИКЕЛЬ
-  (BN) - BŁYSZCZĄCY NIKIEL - SHINY NICKEL - БЛИСТЯЩИЙ НИКЕЛЬ
-  (ZM) - ZŁOTO MATOWE - MATT GOLD - МАТОВОЕ ЗЛОТО



BEL-MOD-PL-3(N) CR



BEL-MOD-PL-3(N)

BELLAGIO MODERN



K U T E K
 CLASSIC

BIB - ZW - 6 (P/A) A
 BIB - ZW - 6 (P/A) SR
 BIB - ZW - 6 (P/A) P
 BIB - ZW - 6 (N/A) A
 BIB - ZW - 6 (N/A) SR
 BIB - ZW - 6 (N/A) P

† 700 mm ↔ 910 mm
 ⚡ 6 x MAX 40W E 14
 ⚡ 2 x MAX 60W E 27

BIB - K - 2 (P/A) P
 BIB - K - 2 (P/A) SR
 BIB - K - 2 (P/A) A
 BIB - K - 2 (N/A) A
 BIB - K - 2 (N/A) SR
 BIB - K - 2 (N/A) P

† 340 mm ↔ 400 mm ↗250
 ⚡ 2 x MAX 40W E 14

BIB - K - 1 (P/A) A
 BIB - K - 1 (P/A) SR
 BIB - K - 1 (P/A) P
 BIB - K - 1 (N/A) A
 BIB - K - 1 (N/A) SR
 BIB - K - 1 (N/A) P

† 340 mm ↔ 180 mm ↗270
 ⚡ 1 x MAX 40W E 14

BIB - ZW - 3 (P/A) A
 BIB - ZW - 3 (P/A) SR
 BIB - ZW - 3 (P/A) P
 BIB - ZW - 3 (N/A) A
 BIB - ZW - 3 (N/A) SR
 BIB - ZW - 3 (N/A) P

† 650 mm ↔ 700 mm
 ⚡ 3 x MAX 40W E 14

BIB - ZW - 8 (P/A) SR
 BIB - ZW - 8 (P/A) A
 BIB - ZW - 8 (P/A) P
 BIB - ZW - 8 (N/A) SR
 BIB - ZW - 8 (N/A) A
 BIB - ZW - 8 (N/A) P

† 800 mm ↔ 1015 mm
 ⚡ 8 x MAX 40W E 14
 ⚡ 3 x MAX 60W E 27

BIB - LS - 3 (P/A) SR
 BIB - LS - 3 (P/A) A
 BIB - LS - 3 (P/A) P
 BIB - LS - 3 (N/A) SR
 BIB - LS - 3 (N/A) A
 BIB - LS - 3 (N/A) P

† 1750 mm ↔ 530 mm
 ⚡ 3 x MAX 40W E 14

BIB - LG - 1 (P) SR
 BIB - LG - 1 (P) A
 BIB - LG - 1 (P) P
 BIB - LG - 1 (N) SR
 BIB - LG - 1 (N) A
 BIB - LG - 1 (N) P

† 530 mm ↔ 310 mm
 ⚡ 1 x MAX 60W E 27

BIB - LG - 1 (P/A)
 BIB - LG - 1 (N/A)

† 540 mm ↔ 320 mm
 ⚡ 1 x MAX 60W E 27

(P) - ПАТІНА - PATINA - ПАТИНА
 (N) - НИКІЛ МАТОВИЙ - ANCIENT NICKEL - АНТИЧНИЙ НИКЕЛЬ

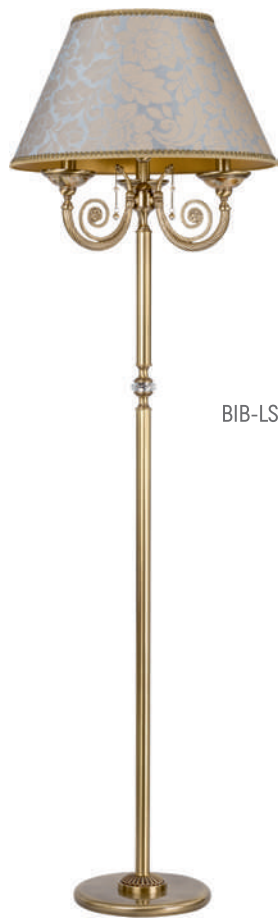

BIB-LS-3 (P/A) SR



BIB-K-2 (P/A) P



BIB-ZW-6 (P/A) A



BIB-ZW-8 (P/A) SR

BIBIONE



BIB-LG-1 (P) SR



BIB-LG-1 (P/A)



BIB-K-1 (P/A) A



BIB-ZW-3 (P/A) A



K U T E K
CLASSIC

CAR - ZWL - 4+1 (P)

CAR - ZWL - 4+1 (N)

↔ 1000 mm

↓ 900 mm

↗ 130 mm

💡 5 x MAX 60W E 27

CAR - ZW - 8 (P)

CAR - ZW - 8 (N)

↔ 850 mm

↓ 700 mm

↗ 600 mm

💡 8 x MAX 60W E 27

CAR - K - 1 (P)

CAR - K - 1 (N)

↓ 280 mm ↔ 120 mm ↗ 170 mm

💡 1 x MAX 60W E 27

CAR - LS - 4 (P)

CAR - LS - 4 (N)

↓ 1740 mm ↔ 470 mm

💡 4 x MAX 60W E 27

CAR - LG - 2 (P)

CAR - LG - 2 (N)

↔ 335 mm

↓ 600 mm

↗ 160 mm

💡 2 x MAX 60W E 27

CAR - ZW - 5 (P)

CAR - ZW - 5 (N)

↓ 490 mm ↔ 700 mm

💡 5 x MAX 60W E 27

CAR - ZW - 9 (P)

CAR - ZW - 9 (N)

↔ 700 mm

↓ 1100 mm

↗ 400 mm

💡 9 x MAX 60W E 27

CAR - ZW - 1 (P)

CAR - ZW - 1 (N)

↓ 700 mm ↔ 130 mm

💡 1 x MAX 60W E 27

GLASS TUBES

 (P) - РАТУНА - PATINA - ПАТИНА
 (N) - НИКЕЛ МАТОВЫЙ - ANCIENT NICKEL - АНТИЧНЫЙ НИКЕЛЬ

CAR-ZW-9 (P)



CAR-ZW-8 (P)



CAR-ZWL-4+1 (P)



CAR-LS-4 (P)

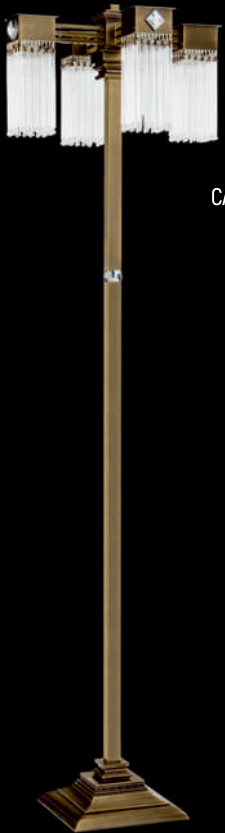

CAR-ZW-1 (P)



CAR-K-1 (P)



CAR-ZW-5 (P)

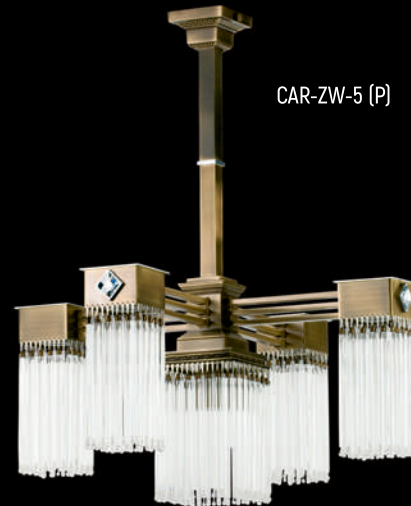

CAR-LG-2 (P)



CARINO

GLASS TUBES



K U T E K
 CLASSIC

CAS - ZW - 10 (P/A)

CAS - ZW - 10 (Z/A)

CAS - ZW - 10 (N/A)

CAS - ZW - 10 (BN/A)

CAS - ZW - 10 (ZM/A)

± 700 mm ↔ 830 mm

💡 10 x MAX 40W E 14

CAS - ZW - 6 (P/A)

CAS - ZW - 6 (Z/A)

CAS - ZW - 6 (N/A)

CAS - ZW - 6 (BN/A)

CAS - ZW - 6 (ZM/A)

± 700 mm ↔ 630 mm

💡 6 x MAX 40W E 14

CAS - K - 2 (P/A)

CAS - K - 2 (Z/A)

CAS - K - 2 (N/A)

CAS - K - 2 (BN/A)

CAS - K - 2 (ZM/A)

± 250 mm ↔ 360 mm ↗ 270 mm

💡 2 x MAX 40W E 14

CAS - K - 1 (P/A)

CAS - K - 1 (Z/A)

CAS - K - 1 (N/A)

CAS - K - 1 (BN/A)

CAS - K - 1 (ZM/A)

± 170 mm ↔ 250 mm ↗ 310 mm

💡 1 x MAX 40W E 14

CAS - ZW - 8 (P/A)

CAS - ZW - 8 (Z/A)

CAS - ZW - 8 (N/A)

CAS - ZW - 8 (BN/A)

CAS - ZW - 8 (ZM/A)

± 700 mm ↔ 700 mm

💡 8 x MAX 40W E 14

CAS - ZW - 5 (P/A)

CAS - ZW - 5 (Z/A)

CAS - ZW - 5 (N/A)

CAS - ZW - 5 (BN/A)

CAS - ZW - 5 (ZM/A)

± 700 mm ↔ 630 mm

💡 5 x MAX 40W E 14

CAS - ZW - 3 (P/A)

CAS - ZW - 3 (Z/A)

CAS - ZW - 3 (N/A)

CAS - ZW - 3 (BN/A)

CAS - ZW - 3 (ZM/A)

± 700 mm ↔ 560 mm

💡 3 x MAX 40W E 14

CAS - LG - 1 (P/A)

CAS - LG - 1 (Z/A)

CAS - LG - 1 (N/A)

CAS - LG - 1 (BN/A)

CAS - LG - 1 (ZM/A)

± 480 mm ↔ 300 mm

💡 1 x MAX 60W E 27

	(P) - ПАТІНА - PATINA - ПАТИНА
	(Z) - ЗОЛОТО - GOLD - ЗОЛОТО
	(N) - НИКІЛ МАТОВИЙ - ANCIENT NICKEL - АНТИЧНИЙ НИКІЛЬ
	(BN) - БІЛІСЯЩІЙ НИКІЛ - SHINY NICKEL - БЛІСЯЩІЙ НИКІЛЬ
	(ZM) - ЗОЛОТО МАТОВЕ - MATT GOLD - МАТОВЕ ЗОЛОТО



CAS-ZW-10 (P/A)



CAS-ZW-8 (P/A)



CAS-ZW-6 (P/A)



CAS-K-2 (P/A)

CASAMIA



CAS-ZW-5 (P/A)



CAS-LG-1 (P/A)



CAS-K-1 (P/A)



CAS-ZW-3 (P/A)



K U T E K
 CLASSIC

CAS - ZW - 8 (P)

CAS - ZW - 8 (Z)

CAS - ZW - 8 (N)

CAS - ZW - 8 (BN)

CAS - ZW - 8 (ZM)

± 700 mm ↔ 870 mm

💡 8 x MAX 60W E 27

CAS - K - 1 (P)

CAS - K - 1 (Z)

CAS - K - 1 (N)

CAS - K - 1 (BN)

CAS - K - 1 (ZM)

± 270 mm ↔ 250 mm ↔ 370 mm

💡 1 x MAX 60W E 27

CAS - LG - 1 (P)

CAS - LG - 1 (Z)

CAS - LG - 1 (N)

CAS - LG - 1 (BN)

CAS - LG - 1 (ZM)

± 370 mm ↔ 300 mm

💡 1 x MAX 60W E 27

CAS - ZW - 6 (P)

CAS - ZW - 6 (Z)

CAS - ZW - 6 (N)

CAS - ZW - 6 (BN)

CAS - ZW - 6 (ZM)

± 700 mm ↔ 820 mm

💡 6 x MAX 60W E 27

CAS - ZW - 5 (P)

CAS - ZW - 5 (Z)

CAS - ZW - 5 (N)

CAS - ZW - 5 (BN)

CAS - ZW - 5 (ZM)

± 700 mm ↔ 720 mm

💡 5 x MAX 60W E 27

CAS - ZW - 3 (P)

CAS - ZW - 3 (Z)

CAS - ZW - 3 (N)

CAS - ZW - 3 (BN)

CAS - ZW - 3 (ZM)

± 700 mm ↔ 640 mm

💡 3 x MAX 60W E 27

- (P) - PATYNA - PATINA - ПАТИНА
- (Z) - ZŁOTO - GOLD - ЗОЛОТО
- (N) - NIKIEL MATOWY - ANCIENT NICKEL - АНТИЧНЫЙ НИКЕЛЬ
- (BN) - BŁYSZCZĄCY NIKIEL - SHINY NICKEL - БЛИСТЯЩИЙ НИКЕЛЬ
- (ZM) - ZŁOTO MATOWE - MATT GOLD - МАТОВОЕ ЗЛОТО



CAS-ZW-8 (P)



CAS-ZW-6 (P)



CAS-K-1 (P)

CAS-LG-1 (P)



CAS-ZW-5 (P)



CAS-ZW-3 (P)

CASAMIA



 K U T E K
 CLASSIC

COC - ZW - 12 (N/A)

COC - ZW - 12 (P/A)

COC - ZW - 12 (Z/A)

COC - ZW - 12 (BN/A)

COC - ZW - 12 (ZM/A)

± 900 mm ↔ 900 mm

💡 12 x MAX 40W E 14

COC - ZW - 6 (Z/A)

COC - ZW - 6 (N/A)

COC - ZW - 6 (P/A)

COC - ZW - 6 (BN/A)

COC - ZW - 6 (ZM/A)

± 700 mm ↔ 730 mm

💡 6 x MAX 40W E 14

COC - ZW - 8 (P/A)

COC - ZW - 8 (Z/A)

COC - ZW - 8 (N/A)

COC - ZW - 8 (BN/A)

COC - ZW - 8 (ZM/A)

± 800 mm ↔ 900 mm

💡 8 x MAX 40W E 14

COC - ZW - 5 (P/A)

COC - ZW - 5 (N/A)

COC - ZW - 5 (Z/A)

COC - ZW - 5 (BN/A)

COC - ZW - 5 (ZM/A)

± 700 mm ↔ 660 mm

💡 5 x MAX 40W E 14

 (P) - PATYNA - PATINA - ПАТИНА
 (Z) - ZŁOTO - GOLD - ЗОЛОТО
 (N) - NIKIEL MATOWY - ANCIENT NICKEL - АНТИЧНЫЙ НИКЕЛЬ
 (BN) - BŁYSZCZĄCY NIKIEL - SHINY NICKEL - БЛИСТАЩИЙ НИКЕЛЬ
 (ZM) - ZŁOTO MATOWE - MATT GOLD - МАТОВОЕ ЗЛОТО



COC-ZW-12 (N/A)



COC-ZW-8 (P/A)



COC-ZW-5 (P/A)



COC-ZW-6 (Z/A)

COCO



K U T E K
 CLASSIC

COC - ZW - 3 (P/A)
 COC - ZW - 3 (N/A)
 COC - ZW - 3 (Z/A)
 COC - ZW - 3 (BN/A)
 COC - ZW - 3 (ZM/A)

† MIN 750 mm ↔ 730 mm
 ⚡ 3 x MAX 40W E 14

COC - K - 2 (P/A)
 COC - K - 2 (Z/A)
 COC - K - 2 (N/A)
 COC - K - 2 (BN/A)
 COC - K - 2 (ZM/A)

† 290 mm ↔ 380 mm ↗ 340 mm
 ⚡ 2 x MAX 40W E 14

COC - K - 1 (Z/A)
 COC - K - 1 (N/A)
 COC - K - 1 (P/A)
 COC - K - 1 (BN/A)
 COC - K - 1 (ZM/A)

† 290 mm ↔ 180 mm ↗ 360 mm
 ⚡ 1 x MAX 40W E 14

COC - LS - 3 (P/A)
 COC - LS - 3 (N/A)
 COC - LS - 3 (Z/A)
 COC - LS - 3 (BN/A)
 COC - LS - 3 (ZM/A)

† 1720 mm ↔ 530 mm
 ⚡ 3 x MAX 40W E 14

COC - LG - 1 (P/A)
 COC - LG - 1 (N/A)
 COC - LG - 1 (Z/A)
 COC - LG - 1 (BN/A)
 COC - LG - 1 (ZM/A)

† 600 mm ↔ 320 mm
 ⚡ 1 x MAX 60W E 27

 (P) - PATYNA - PATINA - ПАТИНА
 (Z) - ZŁOTO - GOLD - ЗОЛОТО
 (N) - NIKIEL MATOWY - ANCIENT NICKEL - АНТИЧНЫЙ НИКЕЛЬ
 (BN) - BŁYSZCZĄCY NIKIEL - SHINY NICKEL - БЛИСТАЩИЙ НИКЕЛЬ
 (ZM) - ZŁOTO MATOWE - MATT GOLD - МАТОВОЕ ЗЛОТО



COC-LS-3 (P/A)



COC-ZW-3(P/A)



COC-K-1 (Z/A)



COC-LG-1 (P/A)



COC-K-2 (P/A)

COCO



K U T E K
 CLASSIC

COC - PODS - 1 (N) 200

COC - PODS - 1 (P) 200

COC - PODS - 1 (Z) 200

COC - PODS - 1 (ZM) 200

‡ 200 mm ↔ 160 mm

💡 1 x MAX 35W GU 10

COC - PODS - 1 (N) 350

COC - PODS - 1 (P) 350

COC - PODS - 1 (Z) 350

COC - PODS - 1 (ZM) 350

‡ 350 mm ↔ 160 mm

💡 1 x MAX 35W GU 10

- (P) - PATYNA - PATINA - ПАТИНА
- (Z) - ZŁOTO - GOLD - ЗОЛОТО
- (N) - NIKIEL MATOWY - ANCIENT NICKEL - АНТИЧНЫЙ НИКЕЛЬ
- (ZM) - ZŁOTO MATOWE - MATT GOLD - МАТОВОЕ ЗЛОТО



COC-PODS-1 (N) 200

COC-PODS-1 (N) 350



COC-PODS-1 (Z) 200



COC-PODS-1 (Z) 350



COC-PODS-1 (P) 200

COC-PODS-1 (P) 350



COCO

ACCENT LIGHTS



 K U T E K
 CLASSIC

COC - PODS - 1 (N) 200 CR

COC - PODS - 1 (P) 200 CR

COC - PODS - 1 (Z) 200 CR

COC - PODS - 1 (ZM) 200 CR

‡ 200 mm ↔ 160 mm

💡 1 x MAX 35W GU 10

COC - PODS - 1 (N) 350 CR

COC - PODS - 1 (P) 350 CR

COC - PODS - 1 (Z) 350 CR

COC - PODS - 1 (ZM) 350 CR

‡ 350 mm ↔ 160 mm

💡 1 x MAX 35W GU 10

-  (P) - PATYNA - PATINA - ПАТИНА
-  (Z) - ZŁOTO - GOLD - ЗОЛОТО
-  (N) - NIKIEL MATOWY - ANCIENT NICKEL - АНТИЧНЫЙ НИКЕЛЬ
-  (ZM) - ZŁOTO MATOWE - MATT GOLD - МАТОВОЕ ЗЛОТО



COC-PODS-1 (N) 200 CR

COC-PODS-1 (N) 350 CR



COC-PODS-1 (Z) 200 CR



COC-PODS-1 (Z) 350 CR



COC-PODS-1 (P) 200 CR

COC-PODS-1 (P) 350 CR



COCO

ACCENT LIGHTS



K U T E K
 CLASSIC

DEC - ZW - 6 (P/A)
 DEC - ZW - 6 (Z/A)
 DEC - ZW - 6 (N/A)
 DEC - ZW - 6 (BN/A)
 DEC - ZW - 6 (ZM/A)

† 700 mm ↔ 720 mm
 ⚡ 6 x MAX 40W E 14

DEC - K - 1 (P/A)
 DEC - K - 1 (Z/A)
 DEC - K - 1 (N/A)
 DEC - K - 1 (BN/A)
 DEC - K - 1 (ZM/A)

† 270 mm ↔ 170 mm ↗ 240 mm
 ⚡ 1 x MAX 40W E 14

DEC - K - 2 (P/A)
 DEC - K - 2 (Z/A)
 DEC - K - 2 (N/A)
 DEC - K - 2 (BN/A)
 DEC - K - 2 (ZM/A)

† 255 mm ↔ 395 mm ↗ 205 mm
 ⚡ 2 x MAX 40W E 14

DEC - ZW - 3 (P/A)
 DEC - ZW - 3 (Z/A)
 DEC - ZW - 3 (N/A)
 DEC - ZW - 3 (BN/A)
 DEC - ZW - 3 (ZM/A)

† 700 mm ↔ 650 mm
 ⚡ 3 x MAX 40W E 14

DEC - LS - 1 (P/A)
 DEC - LS - 1 (Z/A)
 DEC - LS - 1 (N/A)
 DEC - LS - 1 (BN/A)
 DEC - LS - 1 (ZM/A)

† 1720 mm ↔ 400 mm
 ⚡ 1 x MAX 60W E 27

DEC - LG - 1 (P/A)
 DEC - LG - 1 (Z/A)
 DEC - LG - 1 (N/A)
 DEC - LG - 1 (BN/A)
 DEC - LG - 1 (ZM/A)

† 570 mm ↔ 300 mm
 ⚡ 1 x MAX 60W E 27

(P) - PATYNA - PATINA - ПАТИНА
 (Z) - ZŁOTO - GOLD - ЗОЛОТО
 (N) - NIKIEL MATOWY - ANCIENT NICKEL - АНТИЧНЫЙ НИКЕЛЬ
 (BN) - BŁYSZCZĄCY NIKIEL - SHINY NICKEL - БЛИСТАЩИЙ НИКЕЛЬ
 (ZM) - ZŁOTO MATOWE - MATT GOLD - МАТОВОЕ ЗЛОТО



DEC-LS-1 (P/A)



DEC-ZW-6 (P/A)



DEC-ZW-3 (P/A)



DEC-LG-1 (P/A)



DEC-K-2 (P/A)



DEC-K-1 (P/A)

DECOR



K U T E K
CLASSIC

DEC - ZW - 6 (P)
DEC - ZW - 6 (N)
DEC - ZW - 6 (Z)
DEC - ZW - 6 (BN)
DEC - ZW - 6 (ZM)

↓ 680 mm ↔ 830 mm
💡 6 x MAX 60W E 27

DEC - PL - 3 (P)
DEC - PL - 3 (N)
DEC - PL - 3 (Z)
DEC - PL - 3 (BN)
DEC - PL - 3 (ZM)

↓ 560 mm ↔ 500 mm
💡 3 x MAX 60W E 27

DEC - LG - 1 (P)
DEC - LG - 1 (N)
DEC - LG - 1 (Z)
DEC - LG - 1 (BN)
DEC - LG - 1 (ZM)

↓ 520 mm ↔ 300 mm
💡 1 x MAX 60W E 27

DEC - K - 1 (P)
DEC - K - 1 (N)
DEC - K - 1 (Z)
DEC - K - 1 (BN)
DEC - K - 1 (ZM)

↓ 180 mm ↔ 250 mm ↗ 290 mm
💡 1 x MAX 60W E 27

DEC - ZW - 3 (P)
DEC - ZW - 3 (N)
DEC - ZW - 3 (Z)
DEC - ZW - 3 (BN)
DEC - ZW - 3 (ZM)

↓ 680 mm ↔ 620 mm
💡 3 x MAX 60W E 27

DEC - LS - 1 (P)
DEC - LS - 1 (N)
DEC - LS - 1 (Z)
DEC - LS - 1 (ZM)
DEC - LS - 1 (BN)

↓ 1700 mm ↔ 380 mm
💡 1 x MAX 60W E 27

DEC - PLM - 3 (P)
DEC - PLM - 3 (N)
DEC - PLM - 3 (Z)
DEC - PLM - 3 (BN)
DEC - PLM - 3 (ZM)

↓ 290 mm ↔ 500 mm
💡 3 x MAX 60W E 27

DEC - PLM - 3 (P) 470
DEC - PLM - 3 (N) 470
DEC - PLM - 3 (Z) 470
DEC - PLM - 3 (BN) 470
DEC - PLM - 3 (ZM) 470

↓ 200 mm ↔ 470 mm
💡 3 x MAX 60W E 27

■ (P) - ПАТІНА - PATINA - ПАТИНА
■ (Z) - ЗОЛОТО - GOLD - ЗОЛОТО
■ (N) - НИКІЛ МАТОВИЙ - ANCIENT NICKEL - АНТИЧНИЙ НИКІЛЬ
■ (BN) - БІЛІСЬКАЮЧИЙ НИКІЛ - SHINY NICKEL - БЛІСТЯЩИЙ НИКІЛЬ
■ (ZM) - ЗОЛОТО МАТОВЕ - MATT GOLD - МАТОВЕ ЗОЛОТО



DEC-PLM-3 (P)

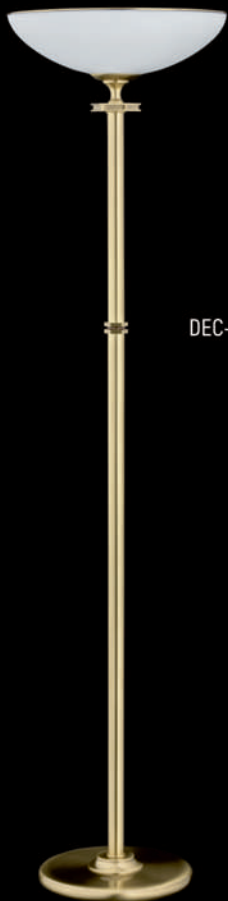

DEC-LS-1 (P)



DEC-ZW-6 (P)



DEC-ZW-3 (P)



DEC-PLM-3 (P) 470



DEC-LG-1 (P)



DEC-PL-3 (P)



DEC-K-1 (P)

DECOR



K U T E K
 CLASSIC

DIM - ZW - 8+4 (Z)

DIM - ZW - 8+4 (N)

DIM - ZW - 8+4 (P)

DIM - ZW - 8+4 (BN)

DIM - ZW - 8+4 (ZM)

± MIN 850 mm ↔ 920 mm

💡 12 x MAX 60W E 27

DIM - ZW - 6 (Z)

DIM - ZW - 6 (P)

DIM - ZW - 6 (N)

DIM - ZW - 6 (BN)

DIM - ZW - 6 (ZM)

± 700 mm ↔ 820 mm

💡 6 x MAX 60W E 27

DIM - ZW - 8 (N)

DIM - ZW - 8 (P)

DIM - ZW - 8 (Z)

DIM - ZW - 8 (BN)

DIM - ZW - 8 (ZM)

± 700 mm ↔ 920 mm

💡 8 x MAX 60W E 27

DIM - ZWL - 4 (BN)

DIM - ZWL - 4 (P)

DIM - ZWL - 4 (Z)

DIM - ZWL - 4 (N)

DIM - ZWL - 4 (ZM)

± 700 mm ↔ 1250 mm

💡 4 x MAX 40W E 14

DIM - K - 2 (P)

DIM - K - 2 (Z)

DIM - K - 2 (N)

DIM - K - 2 (BN)

DIM - K - 2 (ZM)

± 390 mm ↔ 160 mm ↗ 180

💡 2 x MAX 60W E 27

DIM - LS - 1 (P)

DIM - LS - 1 (Z)

DIM - LS - 1 (N)

DIM - LS - 1 (BN)

DIM - LS - 1 (ZM)

± 1640 mm ↔ 300 mm

💡 1 x MAX 60W E 27

- (P) - ПАТІНА - PATINA - ПАТИНА
- (Z) - ЗІЛОТО - GOLD - ЗОЛОТО
- (N) - НИКІЄЛ МАТОВИЙ - ANCIENT NICKEL - АНТИЧНИЙ НИКІЄЛ
- (BN) - БІЛІСЬКАЩАЮЩИЙ НИКІЄЛ - SHINY NICKEL - БЛІСТЯЩИЙ НИКІЄЛ
- (ZM) - ЗІЛОТО МАТОВЕ - MATT GOLD - МАТОВЕ ЗІЛОТО

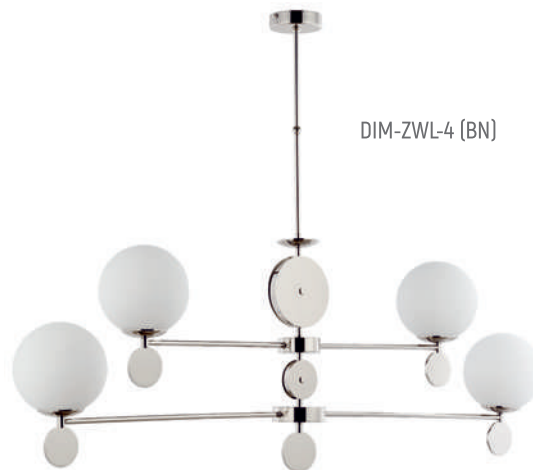

DIMARO



K U T E K
 CLASSIC

DIM - PL - 3 (Z) CR
 DIM - PL - 3 (N) CR
 DIM - PL - 3 (P) CR
 DIM - PL - 3 (BN) CR
 DIM - PL - 3 (ZM) CR

± 110 mm ↔ 580 mm
 ⚡ 3 x MAX 60W E 27

DIM - PL - 3 (Z)
 DIM - PL - 3 (P)
 DIM - PL - 3 (N)
 DIM - PL - 3 (BN)
 DIM - PL - 3 (ZM)

± 110 mm ↔ 580 mm
 ⚡ 3 x MAX 60W E 27

DIM - LG - 1 (BN)
 DIM - LG - 1 (P)
 DIM - LG - 1 (Z)
 DIM - LG - 1 (N)
 DIM - LG - 1 (ZM)

± 440 mm ↔ 200 mm
 ⚡ 1 x MAX 40W E 14

DIM - ZW - 1 (BN) 300
 DIM - ZW - 1 (N) 300
 DIM - ZW - 1 (P) 300
 DIM - ZW - 1 (Z) 300
 DIM - ZW - 1 (ZM) 300

± 700 mm ↔ 300 mm
 ⚡ 1 x MAX 60W E 27

DIM - ZW - 1 (N) 200
 DIM - ZW - 1 (P) 200
 DIM - ZW - 1 (Z) 200
 DIM - ZW - 1 (BN) 200
 DIM - ZW - 1 (ZM) 200

± 700 mm ↔ 200 mm
 ⚡ 1 x MAX 60W E 27

DIM - ZW - 1 (N) 160
 DIM - ZW - 1 (P) 160
 DIM - ZW - 1 (Z) 160
 DIM - ZW - 1 (BN) 160
 DIM - ZW - 1 (ZM) 160

± 700 mm ↔ 160 mm
 ⚡ 1 x MAX 60W E 27

DIM - K - 1 (P)
 DIM - K - 1 (Z)
 DIM - K - 1 (N)
 DIM - K - 1 (BN)
 DIM - K - 1 (ZM)

± 230 mm ↔ 160 mm ↔ 200
 ⚡ 1 x MAX 60W E 27

 (P) - PATYNA - PATINA - ПАТИНА
 (Z) - ZŁOTO - GOLD - ЗОЛОТО
 (N) - NIKIEL MATOWY - ANCIENT NICKEL - АНТИЧНЫЙ НИКЕЛЬ
 (BN) - BŁYSZCZĄCY NIKIEL - SHINY NICKEL - БЛИСТЯЩИЙ НИКЕЛЬ
 (ZM) - ZŁOTO MATOWE - MATT GOLD - МАТОВОЕ ЗЛОТО



DIM-PL-3 (Z) CR



DIM-PL-3 (Z)



DIM-LG-1 (BN)



DIM-K-1 (P)



DIM-ZW-1 (BN)300



DIM-ZW-1 (N) 200



DIM-ZW-1 (N) 160

DIMARO



K U T E K
 CLASSIC

DOR - ZW - 8 (N/A)
 DOR - ZW - 8 (P/A)
 DOR - ZW - 8 (Z/A)
 DOR - ZW - 8 (BN/A)
 DOR - ZW - 8 (ZM/A)

† 700 mm ↔ 720 mm
 ⚡ 8 x MAX 40W E 14

DOR - K - 1 (P/A)
 DOR - K - 1 (N/A)
 DOR - K - 1 (Z/A)
 DOR - K - 1 (BN/A)
 DOR - K - 1 (ZM/A)

† 300 mm ↔ 170 mm ↗ 310 mm
 ⚡ 1 x MAX 40W E 14

DOR - K - 2 (P/A)
 DOR - K - 2 (Z/A)
 DOR - K - 2 (N/A)
 DOR - K - 2 (BN/A)
 DOR - K - 2 (ZM/A)

† 300 mm ↔ 420 mm ↗ 290 mm
 ⚡ 2 x MAX 40W E 14

DOR - ZW - 6 (N/A)
 DOR - ZW - 6 (P/A)
 DOR - ZW - 6 (Z/A)
 DOR - ZW - 6 (BN/A)
 DOR - ZW - 6 (ZM/A)

† 700 mm ↔ 700 mm
 ⚡ 6 x MAX 40W E 14

DOR - ZW - 3 (P/A)
 DOR - ZW - 3 (N/A)
 DOR - ZW - 3 (Z/A)
 DOR - ZW - 3 (BN/A)
 DOR - ZW - 3 (ZM/A)

† 700 mm ↔ 700 mm
 ⚡ 3 x MAX 40W E 14

DOR - LG - 1 (P/A)
 DOR - LG - 1 (N/A)
 DOR - LG - 1 (Z/A)
 DOR - LG - 1 (BN/A)
 DOR - LG - 1 (ZM/A)

† 500 mm ↔ 300 mm
 ⚡ 1 x MAX 60W E 27

 (P) - ПАТІНА - PATINA - ПАТИНА
 (Z) - ЗОЛОТО - GOLD - ЗОЛОТО
 (N) - НИКІЛ МАТОВИЙ - ANCIENT NICKEL - АНТИЧНИЙ НИКЕЛЬ
 (BN) - БІЛІСЯЩАЮЧИЙ НИКІЛ - SHINY NICKEL - БЛИСТЯЩИЙ НИКЕЛЬ
 (ZM) - ЗОЛОТО МАТОВЕ - MATT GOLD - МАТОВЕ ЗОЛОТО



DOR-ZW-6 (N/A)



DOR-ZW-8 (N/A)



DOR-LG-1 (P/A)



DOR-ZW-3 (P/A)



DOR-K-1 (P/A)



DOR-K-2 (P/A)

DORATO



K U T E K
 CLASSIC

ELL - ZW - 4 (Z) 150/V	ELL - ZW - 10 (Z) 250/II
ELL - ZW - 4 (P) 150/V	ELL - ZW - 10 (N) 250/II
ELL - ZW - 4 (Z) 150/V	ELL - ZW - 10 (P) 250/II
ELL - ZW - 4 (BN) 150/V	ELL - ZW - 10 (BN) 250/II
ELL - ZW - 4 (ZM) 150/V	ELL - ZW - 10 (ZM) 250/II

† 1100 mm ↔ 150 mm
 ⚡ 4 x MAX 40W E 14

† 850 mm ↔ 250 mm
 ⚡ 10 x MAX 40W E 14

ELL - ZW - 10 (BN) 350/II	ELL - PLM - 6 (Z) 450/I
ELL - ZW - 10 (N) 350/II	ELL - PLM - 6 (P) 450/I
ELL - ZW - 10 (Z) 350/II	ELL - PLM - 6 (N) 450/I
ELL - ZW - 10 (P) 350/II	ELL - PLM - 6 (BN) 450/I
ELL - ZW - 10 (ZM) 350/II	ELL - PLM - 6 (ZM) 450/I

† 850 mm ↔ 350 mm
 ⚡ 10 x MAX 40W E 14

† 300 mm ↔ 450 mm
 ⚡ 6 x MAX 40W E 14

ELL - PLM - 6 (Z) 250/II	ELL - PLM - 6 (BN) 350/II
ELL - PLM - 6 (N) 250/II	ELL - PLM - 6 (N) 350/II
ELL - PLM - 6 (P) 250/II	ELL - PLM - 6 (Z) 350/II
ELL - PLM - 6 (BN) 250/II	ELL - PLM - 6 (P) 350/II
ELL - PLM - 6 (ZM) 250/II	ELL - PLM - 6 (ZM) 350/II

† 600 mm ↔ 250 mm
 ⚡ 6 x MAX 40W E 14

† 600 mm ↔ 350 mm
 ⚡ 6 x MAX 40W E 14

- (P) - PATYNA - RATINA - ПАТИНА
- (Z) - ZŁOTO - GOLD - ЗОЛОТО
- (N) - NIKIEL MATOWY - ANCIENT NICKEL - АНТИЧНЫЙ НИКЕЛЬ
- (BN) - BŁYSZCZĄCY NIKIEL - SHINY NICKEL - БЛИСТЯЩИЙ НИКЕЛЬ
- (ZM) - ZŁOTO MATOWE - MATT GOLD - МАТОВОЕ ЗЛОТО



ELL-ZW-4 (Z) 150/V



ELL-ZW-10 (Z) 250/II



ELL-ZW-10 (BN) 350/II

ELL-PLM-6 (Z) 450/I



ELL-PLM-6 (Z) 250/II



ELL-PLM-6 (BN) 350/II



ELLINI



K U T E K
 CLASSIC

ELL - PLM - 6 (N) 450/II
 ELL - PLM - 6 (P) 450/II
 ELL - PLM - 6 (Z) 450/II
 ELL - PLM - 6 (BN) 450/II
 ELL - PLM - 6 (ZM) 450/II

† 600 mm ↔ 450 mm
 ⚡ 6 x MAX 40W E 14

ELL - K - 1 (P) 100/III
 ELL - K - 1 (N) 100/III
 ELL - K - 1 (Z) 100/III
 ELL - K - 1 (BN) 100/III
 ELL - K - 1 (ZM) 100/III

† 300 mm ↔ 105 mm ↗160
 ⚡ 1 x MAX 60W E 27

ELL - ZW - 10 (N) 450/II
 ELL - ZW - 10 (Z) 450/II
 ELL - ZW - 10 (P) 450/II
 ELL - ZW - 10 (BN) 450/II
 ELL - ZW - 10 (ZM) 450/II

† 1100 mm ↔ 450 mm
 ⚡ 10 x MAX 40W E 14

ELL - OCZ - 1 (N) 105/II
 ELL - OCZ - 1 (P) 105/II
 ELL - OCZ - 1 (Z) 105/II
 ELL - OCZ - 1 (BN) 105/II
 ELL - OCZ - 1 (ZM) 105/II

† 180 mm ↔ 105 mm
 ⚡ 1 x MAX 60W E 27

- (P) - PATYNA - PATINA - ПАТИНА
- (Z) - ZŁOTO - GOLD - ЗОЛОТО
- (N) - NIKIEL MATOWY - ANCIENT NICKEL - АНТИЧНЫЙ НИКЕЛЬ
- (BN) - BŁYSZCZĄCY NIKIEL - SHINY NICKEL - БЛИСТЯЩИЙ НИКЕЛЬ
- (ZM) - ZŁOTO MATOWE - MATT GOLD - МАТОВОЕ ЗЛОТО

ELL-PLM-6 (N) 450/II



ELL-ZW-10 (N) 450/II



ELL-OCZ-1 (N) 105/II



ELL-K-1 (P) 100/III



ELLINI



K U T E K
CLASSIC

ELV - PODS - 1 (Z) 380 DL
ELV - PODS - 1 (P) 380 DL
ELV - PODS - 1 (N) 380 DL
ELV - PODS - 1 (BN) 380 DL
ELV - PODS - 1 (ZM) 380 DL

‡ 380 mm ↔ 310 mm
💡 24 V 4,8 W - 700 lm - 3000 K

ELV - PODS - 1 (P) 380 KR
ELV - PODS - 1 (N) 380 KR
ELV - PODS - 1 (Z) 380 KR
ELV - PODS - 1 (BN) 380 KR
ELV - PODS - 1 (ZM) 380 KR

‡ 250 mm ↔ 310 mm
💡 24 V 4,8 W - 700 lm - 3000 K

ELV - PODS - 1 (P) 250 KR
ELV - PODS - 1 (N) 250 KR
ELV - PODS - 1 (Z) 250 KR
ELV - PODS - 1 (BN) 250 KR
ELV - PODS - 1 (ZM) 250 KR

‡ 250 mm ↔ 120 mm
💡 12 V dc - 3,6 W - 580 lm - 3000 K

ELV - PODS - 1 (P) 380 DL
ELV - PODS - 1 (N) 380 DL
ELV - PODS - 1 (Z) 380 DL
ELV - PODS - 1 (BN) 380 DL
ELV - PODS - 1 (ZM) 380 DL

‡ 380 mm ↔ 310 mm
💡 24 V 4,8W - 700 lm - 3000 K

ELV - PODS - 1 (Z) 250 KR
ELV - PODS - 1 (P) 250 KR
ELV - PODS - 1 (N) 250 KR
ELV - PODS - 1 (BN) 250 KR
ELV - PODS - 1 (ZM) 250 KR

‡ 250 mm ↔ 120 mm
💡 12 V dc - 3,6 W - 580 lm - 3000 K

- (P) - PATYNA - PATINA - ПАТИНА
- (Z) - ŻŁOTO - GOLD - ЗОЛОТО
- (N) - NIKIEL MATOWY - ANCIENT NICKEL - АНТИЧНЫЙ НИКЕЛЬ
- (BN) - BŁYSZCZĄCY NIKIEL - SHINY NICKEL - БЛИСТЯЩИЙ НИКЕЛЬ
- (ZM) - ŻŁOTO MATOWE - MATT GOLD - МАТОВОЕ ЗЛОТО



ELV-PODS-1 (Z) 380 DL



ELV-PODS-1 (P) 380 DL



ELV-PODS-1 (P) 380 KR



ELV-PODS-1 (Z) 250 KR



ELV-PODS-1 (P) 250 KR

ELVE



K U T E K
 CLASSIC

FAR - ZW - 12 (P)

FAR - ZW - 12 (ZM)

± MIN 800 mm ↔ 1020 mm

💡 12 x MAX 60W E 27

💡 3 x MAX 40W E 14

FAR - ZW - 6 (P)

FAR - ZW - 6 (ZM)

± 700 mm ↔ 820 mm

💡 6 x MAX 60W E 27

💡 2 x MAX 40W E 14

FAR - K - 1 (P)

FAR - K - 1 (ZM)

± 210 mm ↔ 200 mm ↗ 270

💡 1 x MAX 60W E 27

FAR - LS - 1 (P)

FAR - LS - 1 (ZM)

± 1770 mm ↔ 440 mm

💡 1 x MAX 60W E 27

FAR - ZW - 8 (P)

FAR - ZW - 8 (ZM)

± 700 mm ↔ 880 mm

💡 8 x MAX 60W E 27

💡 2 x MAX 40W E 14

FAR - PLM - 3 (P)

FAR - PLM - 3 (ZM)

± 300 mm ↔ 470 mm

💡 3 x MAX 60W E 27

FAR - LG - 1 (P)

FAR - LG - 1 (ZM)

± 550 mm ↔ 300 mm

💡 1 x MAX 60W E 27

 (P) - ПАТІНА - PATINA - ПАТИНА

 (ZM) - ЗЛІТО МАТОВЕ - MATT GOLD - МАТОВОЕ ЗЛОТО

FAR-ZW-8 (P)



FAR-ZW-12 (P)



FAR-ZW-6 (P)



FAR-LS-1 (P)



FAR-LG-1 (P)



FAR-PLM-3 (P)



FAR-K-1 (P)



FARINI



K U T E K
 CLASSIC

FEL - ZW - 21 (P/A)
 FEL - ZW - 21 (N/A)
 FEL - ZW - 21 (Z/A)
 FEL - ZW - 21 (BN/A)
 FEL - ZW - 21 (ZM/A)

† 1000 mm ↔ 1060 mm
 ⚡ 21 x MAX 40W E 14

FEL - ZW - 10 (P/A)
 FEL - ZW - 10 (Z/A)
 FEL - ZW - 10 (N/A)
 FEL - ZW - 10 (BN/A)
 FEL - ZW - 10 (ZM/A)

† 700 mm ↔ 940 mm
 ⚡ 10 x MAX 40W E 14

FEL - ZW - 6 (N/A)
 FEL - ZW - 6 (Z/A)
 FEL - ZW - 6 (P/A)
 FEL - ZW - 6 (BN/A)
 FEL - ZW - 6 (ZM/A)

† 700 mm ↔ 740 mm
 ⚡ 6 x MAX 40W E 14

FEL - ZW - 15 (P/A)
 FEL - ZW - 15 (N/A)
 FEL - ZW - 15 (Z/A)
 FEL - ZW - 15 (BN/A)
 FEL - ZW - 15 (ZM/A)

† 700 mm ↔ 940 mm
 ⚡ 15 x MAX 40W E 14

FEL - ZW - 8 (BN/A)
 FEL - ZW - 8 (P/A)
 FEL - ZW - 8 (N/A)
 FEL - ZW - 8 (Z/A)
 FEL - ZW - 8 (ZM/A)

† 700 mm ↔ 940 mm
 ⚡ 8 x MAX 40W E 14

FEL - ZWL - 6 (P/A)
 FEL - ZWL - 6 (Z/A)
 FEL - ZWL - 6 (N/A)
 FEL - ZWL - 6 (BN/A)
 FEL - ZWL - 6 (ZM/A)

† 700 mm ↔ 1220 mm
 ⚡ 6 x MAX 40W E 14

 (P) - PATYNA - PATINA - ПАТИНА
 (Z) - ZŁOTO - GOLD - ЗОЛОТО
 (N) - NIKIEL MATOWY - ANCIENT NICKEL - АНТИЧНЫЙ НИКЕЛЬ
 (BN) - BŁYSZCZĄCY NIKIEL - SHINY NICKEL - БЛИСТЯЩИЙ НИКЕЛЬ
 (ZM) - ZŁOTO MATOWE - MATT GOLD - МАТОВОЕ ЗОЛОТО



FEL-ZW-21 (P/A)



FEL-ZW-6 (N/A)



FEL-ZW-10 (P/A)

FELLINO



FEL-ZW-15 (P/A)



FEL-ZW-8 (BN/A)



FEL-ZWL-6 (P/A)



K U T E K
 CLASSIC

FEL - ZWL - 4 (P/A) KR
 FEL - ZWL - 4 (N/A) KR
 FEL - ZWL - 4 (Z/A) KR
 FEL - ZWL - 4 (BN/A) KR
 FEL - ZWL - 4 (ZM/A) KR

† 700 mm ↔ 840 mm
 ⚡ 4 x MAX 40W E 14

FEL - K - 1 (Z/A)
 FEL - K - 1 (P/A)
 FEL - K - 1 (N/A)
 FEL - K - 1 (BN/A)
 FEL - K - 1 (ZM/A)

† 315 mm ↔ 150 mm ↗ 230 mm
 ⚡ 1 x MAX 40W E 14

FEL - LS - 1 (Z/A)
 FEL - LS - 1 (P/A)
 FEL - LS - 1 (N/A)
 FEL - LS - 1 (BN/A)
 FEL - LS - 1 (ZM/A)

† 1860 mm ↔ 440 mm
 ⚡ 1 x MAX 60W E 27

FEL - ZWL - 4 (P/A) DL
 FEL - ZWL - 4 (Z/A) DL
 FEL - ZWL - 4 (N/A) DL
 FEL - ZWL - 4 (BN/A) DL
 FEL - ZWL - 4 (ZM/A) DL

† 700 mm ↔ 1220 mm
 ⚡ 4 x MAX 40W E 14

FEL - ZWD - 1 (BN/A)
 FEL - ZWD - 1 (P/A)
 FEL - ZWD - 1 (N/A)
 FEL - ZWD - 1 (Z/A)
 FEL - ZWD - 1 (ZM/A)

† 1000 mm ↔ 450 mm
 ⚡ 1 x MAX 60W E 27

FEL - LG - 1 (BN/A)
 FEL - LG - 1 (P/A)
 FEL - LG - 1 (N/A)
 FEL - LG - 1 (Z/A)
 FEL - LG - 1 (ZM/A)

† 690 mm ↔ 300 mm
 ⚡ 1 x MAX 60W E 27

- (P) - PATYNA - PATINA - ПАТИНА
- (Z) - ZŁOTO - GOLD - ЗОЛОТО
- (N) - NIKIEL MATOWY - ANCIENT NICKEL - АНТИЧНЫЙ НИКЕЛЬ
- (BN) - BŁYSZCZĄCY NIKIEL - SHINY NICKEL - БЛИСТЯЩИЙ НИКЕЛЬ
- (ZM) - ZŁOTO MATOWE - MATT GOLD - МАТОВОЕ ЗЛОТО



FEL-LS-1 (Z/A)



FEL-ZWD-1 (BN/A)

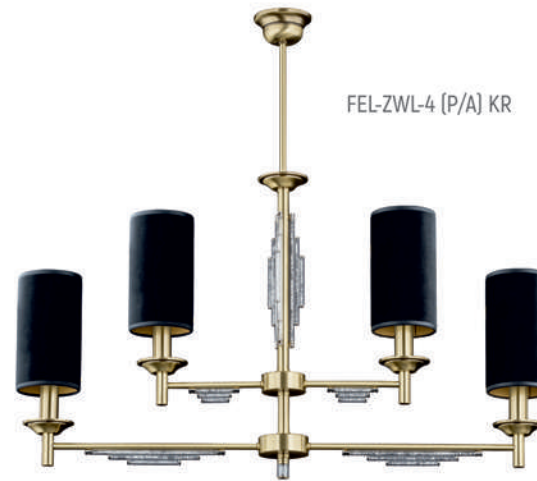

FEL-ZWL-4 (P/A) KR



FEL-K-1 (Z/A)



FEL-LG-1 (BN/A)

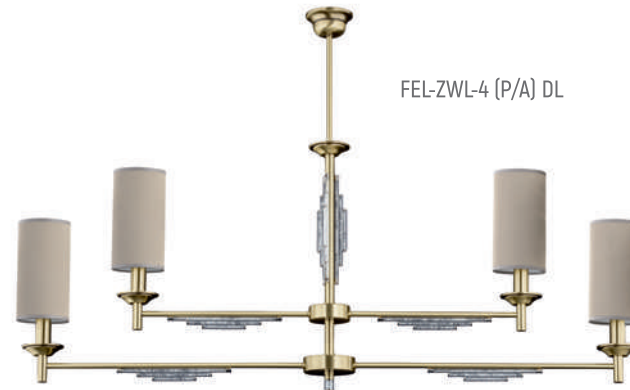

FEL-ZWL-4 (P/A) DL

FELLINO



K U T E K
CLASSIC

FIL - ZW - 10 (P) 350/270
FIL - ZW - 10 (Z) 350/270
FIL - ZW - 10 (N) 350/270
FIL - ZW - 10 (BN) 350/270
FIL - ZW - 10 (ZM) 350/270

↓ MIN 950 mm ↔ 350 mm
💡 10 x MAX 40W E 14

FIL - ZW - 13 (P) 600/500
FIL - ZW - 13 (Z) 600/500
FIL - ZW - 13 (N) 600/500
FIL - ZW - 13 (BN) 600/500
FIL - ZW - 13 (ZM) 600/500

↓ MIN 1800 mm ↔ 600 mm
💡 13 x MAX 40W E 14

FIL - K - 1 (Z) 100/270
FIL - K - 1 (N) 100/270
FIL - K - 1 (P) 100/270
FIL - K - 1 (BN) 100/270
FIL - K - 1 (ZM) 100/270

↓ 460 mm ↔ 100 mm ↗ 150 mm
💡 1 x MAX 40W E 14

FIL - K - 2 (Z) 130/500
FIL - K - 2 (N) 130/500
FIL - K - 2 (P) 130/500
FIL - K - 2 (BN) 130/500
FIL - K - 2 (ZM) 130/500

↓ 680 mm ↔ 140 mm ↗ 180 mm
💡 2 x MAX 40W E 14

FIL - ZW - 4 (Z) 150/500
FIL - ZW - 4 (P) 150/500
FIL - ZW - 4 (N) 150/500
FIL - ZW - 4 (BN) 150/500
FIL - ZW - 4 (ZM) 150/500

↓ MIN 800 mm ↔ 150 mm
💡 4 x MAX 40W E 14

FIL - ZW - 10 (P) 450/270
FIL - ZW - 10 (Z) 450/270
FIL - ZW - 10 (N) 450/270
FIL - ZW - 10 (BN) 450/270
FIL - ZW - 10 (ZM) 450/270

↓ MIN 950 mm ↔ 450 mm
💡 10 x MAX 40W E 14

FIL - OCZ - 1 (Z) 105/120
FIL - OCZ - 1 (N) 105/120
FIL - OCZ - 1 (P) 105/120
FIL - OCZ - 1 (BN) 105/120
FIL - OCZ - 1 (ZM) 105/120

↓ 160 mm ↔ 105 mm
💡 1 x MAX 60W E 27

FIL - ZW - 10 (BN) 250/270
FIL - ZW - 10 (N) 250/270
FIL - ZW - 10 (Z) 250/270
FIL - ZW - 10 (P) 250/270
FIL - ZW - 10 (ZM) 250/270

↓ MIN 950 mm ↔ 250 mm
💡 10 x MAX 40W E 14

- (P) - PATYNA - PATINA - ПАТИНА
- (Z) - ZŁOTO - GOLD - ЗОЛОТО
- (N) - NIKIEL MATOWY - ANCIENT NICKEL - АНТИЧНЫЙ НИКЕЛЬ
- (BN) - BŁYSZCZĄCY NIKIEL - SHINY NICKEL - БЛИСТЯЩИЙ НИКЕЛЬ
- (ZM) - ZŁOTO MATOWE - MATT GOLD - МАТОВОЕ ЗЛОТО



FIL-ZW-10 (P) 350/270



FIL-ZW-10 (BN) 250/270



FIL-ZW-13 (P) 600/500

FIL-ZW-10 (P) 450/270



FIL-K-1 (Z) 100/270



FIL-ZW-4 (Z) 150/500



FIL-OCZ-1 (Z) 105/120

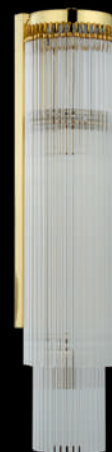

FIL-K-2 (Z) 130/500

FILAGO



K U T E K
 CLASSIC

FIL - PLM - 10 (P) 600/500
 FIL - PLM - 10 (Z) 600/500
 FIL - PLM - 10 (N) 600/500
 FIL - PLM - 10 (BN) 600/500
 FIL - PLM - 10 (ZM) 600/500

± 1650 mm ↔ 600 mm
 ⚡ 10 x MAX 40W E 14

FIL - PLM - 7 (P) 450/270
 FIL - PLM - 7 (Z) 450/270
 FIL - PLM - 7 (N) 450/270
 FIL - PLM - 7 (BN) 450/270
 FIL - PLM - 7 (ZM) 450/270

± 750 mm ↔ 450 mm
 ⚡ 7 x MAX 40W E 14

FIL - K - 1 (BN) 100/170
 FIL - K - 1 (Z) 100/170
 FIL - K - 1 (P) 100/170
 FIL - K - 1 (N) 100/170
 FIL - K - 1 (ZM) 100/170

± 300 mm ↔ 100 mm ↔ 150 mm
 ⚡ 1 x MAX 40W E 14

FIL - PLM - 7 (P) 350/270
 FIL - PLM - 7 (Z) 350/270
 FIL - PLM - 7 (N) 350/270
 FIL - PLM - 7 (BN) 350/270
 FIL - PLM - 7 (ZM) 350/270

± 750 mm ↔ 350 mm
 ⚡ 7 x MAX 40W E 14

FIL - PLM - 7 (BN) 250/270
 FIL - PLM - 7 (Z) 250/270
 FIL - PLM - 7 (N) 250/270
 FIL - PLM - 7 (P) 250/270
 FIL - PLM - 7 (ZM) 250/270

± 750 mm ↔ 250 mm
 ⚡ 7 x MAX 40W E 14

FIL - PLM - 10 (P) 600/1000
 FIL - PLM - 10 (N) 600/1000
 FIL - PLM - 10 (Z) 600/1000
 FIL - PLM - 10 (BN) 600/1000
 FIL - PLM - 10 (ZM) 600/1000

± 3800 mm ↔ 600 mm
 ⚡ 10 x MAX 40W E 14

- (P) - PATYNA - PATINA - ПАТИНА
- (Z) - ZŁOTO - GOLD - ЗОЛОТО
- (N) - NIKIEL MATOWY - ANCIENT NICKEL - АНТИЧНЫЙ НИКЕЛЬ
- (BN) - BŁYSZCZĄCY NIKIEL - SHINY NICKEL - БЛИСТЯЩИЙ НИКЕЛЬ
- (ZM) - ZŁOTO MATOWE - MATT GOLD - МАТОВОЕ ЗЛОТО



FIL-PLM-10 (P) 600/1000



FIL-PLM-10 (P) 600/500



FIL-PLM-7 (P) 350/270



FIL-PLM-7 (P) 450/270



FIL-PLM-7 (BN) 250/270



FIL-K-1 (BN) 100/170

FILAGO



K U T E K
 CLASSIC

FIO - ZW - 6+1 (P)

FIO - ZW - 6+1 (N)

± MIN 850 mm ↔ 600 mm

💡 7 x MAX 60W E 27

FIO - ZW - 1 (P) 150

FIO - ZW - 1 (N) 150

± 700 mm ↔ 150 mm

💡 1 x MAX 60W E 27

FIO - K - 1 (P)

FIO - K - 1 (N)

± 330 mm ↔ 110 mm ↗ 270 mm

💡 1 x MAX 60W E 27

FIO - ZW - 8+1 (P)

FIO - ZW - 8+1 (N)

± 900 mm ↔ 800 mm

💡 9 x MAX 60W E 27

FIO - ZW - 3+1 (P)

FIO - ZW - 3+1 (N)

± 700 mm ↔ 500 mm

💡 4 x MAX 60W E 27

FIO - ZW - 1 (P) 110

FIO - ZW - 1 (N) 110

± 700 mm ↔ 110 mm

💡 1 x MAX 60W E 27

(P) - ПАТІНА - PATINA - ПАТИНА

(N) - НИКІЛ МАТОВИЙ - ANCIENT NICKEL - АНТИЧНИЙ НИКЕЛЬ



FIO-ZW-6+1 (P)



FIO-ZW-1 (P) 150



FIO-ZW-3+1 (P)



FIO-ZW-8+1 (P)

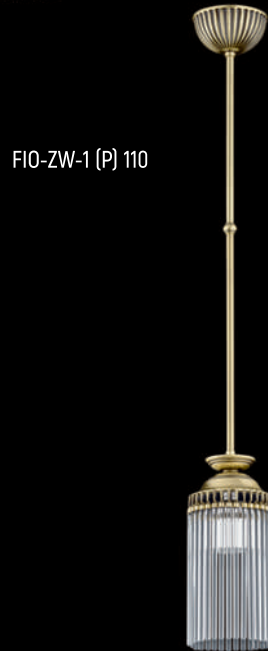

FIO-ZW-1 (P) 110



FIO-K-1 (P)

FIORE



K U T E K
 CLASSIC

FIO - LS - 3 (P)

FIO - LS - 3 (N)

± 1660 mm ↔ 500 mm

💡 3 x MAX 60W E 27

FIO - ZWD - 1 (N) III

FIO - ZWD - 1 (P) III

± MIN 850 mm ↔ 330 mm

💡 7 x MAX 40W E 14

FIO - PL - 9 (P) 600/270

FIO - PL - 9 (N) 600/270

± MIN 820 mm ↔ 600 mm

💡 9 x MAX 40W E 14

FIO - ZWD - 1 (P)

FIO - ZWD - 1 (N)

± 650 mm ↔ 340 mm

💡 4 x MAX 40W E 14

FIO - PLM - 4 (N)

FIO - PLM - 4 (P)

± 410 mm ↔ 340 mm

💡 4 x MAX 40W E 14

FIO - LG - 1 (P)

FIO - LG - 1 (N)

± 470 mm ↔ 160 mm

💡 1 x MAX 60W E 27

 (P) - ПАТІНА - PATINA - ПАТИНА

 (N) - НИКІЛ МАТОВИЙ - ANCIENT NICKEL - АНТИЧНИЙ НИКЕЛЬ



FIO-LS-3 (P)



FIO-ZWD-1 (P)



FIO-ZWD-1 (N) III



FIO-PLM-4 (N)



FIO-LG-1 (P)



FIO-PL-9 (P)600/270

FIORE



K U T E K
 CLASSIC

GEN - ZW - 8 + 4 (P/A)
 GEN - ZW - 8 + 4 (N/A)
 GEN - ZW - 8 + 4 (Z/A)
 GEN - ZW - 8 + 4 (BN/A)
 GEN - ZW - 8 + 4 (ZM/A)

† 900 mm ↔ 760 mm
 ⚡ 12 x MAX 40W E 14

GEN - K - 1 (ZM/A)
 GEN - K - 1 (P/A)
 GEN - K - 1 (N/A)
 GEN - K - 1 (Z/A)
 GEN - K - 1 (BN/A)

† 395 mm ↔ 120 mm ↗ 180 mm
 ⚡ 1 x MAX 40W E 14

GEN - LG - 1 (P/A)
 GEN - LG - 1 (Z/A)
 GEN - LG - 1 (N/A)
 GEN - LG - 1 (BN/A)
 GEN - LG - 1 (ZM/A)

† 670 mm ↔ 250 mm
 ⚡ 1 x MAX 60W E 27

GEN - ZW - 8 (P/A)
 GEN - ZW - 8 (N/A)
 GEN - ZW - 8 (Z/A)
 GEN - ZW - 8 (BN/A)
 GEN - ZW - 8 (ZM/A)

† 970 mm ↔ 720 mm
 ⚡ 8 x MAX 40W E 14

GEN - ZW - 6 (P/A)
 GEN - ZW - 6 (N/A)
 GEN - ZW - 6 (Z/A)
 GEN - ZW - 6 (BN/A)
 GEN - ZW - 6 (ZM/A)

† 700 mm ↔ 740 mm
 ⚡ 6 x MAX 40W E 14

GEN - ZW - 3 (P/A)
 GEN - ZW - 3 (N/A)
 GEN - ZW - 3 (Z/A)
 GEN - ZW - 3 (BN/A)
 GEN - ZW - 3 (ZM/A)

† 740 mm ↔ 640 mm
 ⚡ 3 x MAX 40W E 14

 (P) - PATYNA - PATINA - ПАТИНА
 (Z) - ZŁOTO - GOLD - ЗОЛОТО
 (N) - NIKIEL MATOWY - ANCIENT NICKEL - АНТИЧНЫЙ НИКЕЛЬ
 (BN) - BŁYSZCZĄCY NIKIEL - SHINY NICKEL - БЛИСТЯЩИЙ НИКЕЛЬ
 (ZM) - ZŁOTO MATOWE - MATT GOLD - МАТОВОЕ ЗЛОТО



GEN-ZW-8 (P/A)



GEN-ZW-8+4 (P/A)



GEN-ZW-6 (P/A)



GEN-LG-1 (P/A)



GEN-ZW-3 (P/A)



GEN-K-1 (ZM/A)

GENOVA



K U T E K
 CLASSIC

KAM - ZW - 6 (P)

KAM - ZW - 6 (N)

KAM - ZW - 6 (Z)

KAM - ZW - 6 (BN)

KAM - ZW - 6 (ZM)

± 700 mm ↔ 950 mm

💡 12 x MAX 5W G 9

KAM - ZW - 3 (N)

KAM - ZW - 3 (B)

KAM - ZW - 3 (Z)

KAM - ZW - 3 (BN)

KAM - ZW - 3 (ZM)

± 700 mm ↔ 610 mm

💡 6 x MAX 5W G 9

KAM - K - 2 (Z)

KAM - K - 2 (P)

KAM - K - 2 (N)

KAM - K - 2 (BN)

KAM - K - 2 (ZM)

± 120 mm ↔ 360 mm ↗ 140 mm

💡 2 x MAX 5W G 9

- (P) - PATYNA - PATINA - ПАТИНА
- (Z) - ZŁOTO - GOLD - ЗОЛОТО
- (N) - NIKIEL MATOWY - ANCIENT NICKEL - АНТИЧНЫЙ НИКЕЛЬ
- (BN) - BŁYSZCZĄCY NIKIEL - SHINY NICKEL - БЛИСТЯЩИЙ НИКЕЛЬ
- (ZM) - ZŁOTO MATOWE - MATT GOLD - МАТОВОЕ ЗЛОТО



KAM-ZW-6 (P)



KAM-ZW-3 (N)



KAM-K-2 (Z)

KAMMA



K U T E K
 CLASSIC

LAU - ZW - 2 (Z) 310/R
 LAU - ZW - 2 (P) 310/R
 LAU - ZW - 2 (N) 310/R
 LAU - ZW - 2 (BN) 310/R
 LAU - ZW - 2 (ZM) 310/R

† 700 mm ↔ 310/85 mm
 ⚡ 2 x MAX 40W E 14

LAU - K - 2 (Z)
 LAU - K - 2 (N)
 LAU - K - 2 (P)
 LAU - K - 2 (BN)
 LAU - K - 2 (ZM)

† 475 mm ↔ 100 mm ↗ 150 mm
 ⚡ 2 x MAX 40W E 14

LAU - K - 1 (P)
 LAU - K - 1 (N)
 LAU - K - 1 (Z)
 LAU - K - 1 (BN)
 LAU - K - 1 (ZM)

† 255 mm ↔ 100 mm ↗ 160 mm
 ⚡ 1 x MAX 40W E 14

LAU - ZW - 2 (N) 240/R
 LAU - ZW - 2 (P) 240/R
 LAU - ZW - 2 (Z) 240/R
 LAU - ZW - 2 (BN) 240/R
 LAU - ZW - 2 (ZM) 240/R

† 700 mm ↔ 240/85 mm
 ⚡ 2 x MAX 40W E 14

LAU - LG - 2 (Z)
 LAU - LG - 2 (P)
 LAU - LG - 2 (N)
 LAU - LG - 2 (BN)
 LAU - LG - 2 (ZM)

† 320 mm ↔ 310/85 mm
 ⚡ 2 x MAX 40W E 14

LAU - LS - 1 (N/A)
 LAU - LS - 1 (Z/A)
 LAU - LS - 1 (P/A)
 LAU - LS - 1 (BN/A)
 LAU - LS - 1 (ZM/A)

† 1850 mm ↔ 300 mm
 ⚡ 1 x MAX 60W E 27

- (P) - PATYNA - PATINA - ПАТИНА
- (Z) - ZŁOTO - GOLD - ЗОЛОТО
- (N) - NIKIEL MATOWY - ANCIENT NICKEL - АНТИЧНЫЙ НИКЕЛЬ
- (BN) - BŁYSZCZĄCY NIKIEL - SHINY NICKEL - БЛИСТЯЩИЙ НИКЕЛЬ
- (ZM) - ZŁOTO MATOWE - MATT GOLD - МАТОВОЕ ЗЛОТО



LAU-LS-1 (N/A)

LAU-ZW-2 (Z) 310/R



LAU-K-2 (Z)

LAU-ZW-2 (N) 240/R



LAURIA



LAU-LG-2 (Z)



LAU-K-1 (P)



K U T E K
 CLASSIC

LAV - ZW - 6 (P)	600 - 1/R	LAV - ZWL - 6 (Z)	240
LAV - ZW - 6 (Z)	600 - 1/R	LAV - ZWL - 6 (P)	240
LAV - ZW - 6 (N)	600 - 1/R	LAV - ZWL - 6 (N)	240
LAV - ZW - 6 (BN)	600 - 1/R	LAV - ZWL - 6 (BN)	240
LAV - ZW - 6 (ZM)	600 - 1/R	LAV - ZWL - 6 (ZM)	240

† 700 mm - MIN 200 mm ↔ 600 mm
 ⚡ 6 x MAX 40W E 14

† 700 mm ↔ 1010 mm
 ⚡ 6 x MAX 40W E 14

LAV - ZW - 6 (BN)	600 - 2/R	LAV - PLM - 6 (P)	600 - 1
LAV - ZW - 6 (Z)	600 - 2/R	LAV - PLM - 6 (Z)	600 - 1
LAV - ZW - 6 (N)	600 - 2/R	LAV - PLM - 6 (N)	600 - 1
LAV - ZW - 6 (P)	600 - 2/R	LAV - PLM - 6 (BN)	600 - 1
LAV - ZW - 6 (ZM)	600 - 2/R	LAV - PLM - 6 (ZM)	600 - 1

† 700 mm - MIN 200 mm ↔ 600 mm
 ⚡ 6 x MAX 40W E 14

† MIN 85 mm ↔ 600 mm
 ⚡ 6 x MAX 40W E 14

LAV - PLM - 6 (BN)	600 - 2	LAV - LG - 2 (P)
LAV - PLM - 6 (N)	600 - 2	LAV - LG - 2 (Z)
LAV - PLM - 6 (Z)	600 - 2	LAV - LG - 2 (N)
LAV - PLM - 6 (P)	600 - 2	LAV - LG - 2 (BN)
LAV - PLM - 6 (ZM)	600 - 2	LAV - LG - 2 (ZM)

† 150 mm ↔ 600 mm
 ⚡ 6 x MAX 40W E 14

† 440 mm ↔ 310 mm
 ⚡ 2 x MAX 40W E 14

	(P) - PATYNA - PATINA - ПАТИНА
	(Z) - ZŁOTO - GOLD - ЗОЛОТО
	(N) - NIKIEL MATOWY - ANCIENT NICKEL - АНТИЧНЫЙ НИКЕЛЬ
	(BN) - BŁYSZCZĄCY NIKIEL - SHINY NICKEL - БЛИСТЯЩИЙ НИКЕЛЬ
	(ZM) - ZŁOTO MATOWE - MATT GOLD - МАТОВОЕ ЗОЛОТО



LAV-ZW-6 (P) 600-1/R



LAV-ZW-6 (BN) 600-2/R



LAV-PLM-6 (P) 600-1



LAV-ZWL-6 (Z) 240



LAV-PLM-6 (BN) 600-2



LAV-LG-2 (P)

LAVONE



K U T E K
 CLASSIC

LAV - ZW - 3 (Z) 310 - 1/R
 LAV - ZW - 3 (N) 310 - 1/R
 LAV - ZW - 3 (P) 310 - 1/R
 LAV - ZW - 3 (BN) 310 - 1/R
 LAV - ZW - 3 (ZM) 310 - 1/R

† 700 MIN - 200 mm ↔ 310 mm
 ⚡ 3 x MAX 40W E 14

LAV - ZW - 3 (Z) 310 - 2/R
 LAV - ZW - 3 (P) 310 - 2/R
 LAV - ZW - 3 (N) 310 - 2/R
 LAV - ZW - 3 (BN) 310 - 2/R
 LAV - ZW - 3 (ZM) 310 - 2/R

† 700 mm - MIN 200 mm ↔ 310 mm
 ⚡ 3 x MAX 40W E 14

LAV - ZW - 6 (P) 440 - 1/R
 LAV - ZW - 6 (Z) 440 - 1/R
 LAV - ZW - 6 (N) 440 - 1/R
 LAV - ZW - 6 (BN) 440 - 1/R
 LAV - ZW - 6 (ZM) 440 - 1/R

† 700 mm - MIN 200 mm ↔ 440 mm
 ⚡ 6 x MAX 40W E 14

LAV - PLM - 6 (P) 440 - 1
 LAV - PLM - 6 (N) 440 - 1
 LAV - PLM - 6 (Z) 440 - 1
 LAV - PLM - 6 (BN) 440 - 1
 LAV - PLM - 6 (ZM) 440 - 1

† 85 mm ↔ 440 mm
 ⚡ 6 x MAX 40W E 14

LAV - PLM - 6 (P) 440 - 2
 LAV - PLM - 6 (Z) 440 - 2
 LAV - PLM - 6 (N) 440 - 2
 LAV - PLM - 6 (BN) 440 - 2
 LAV - PLM - 6 (ZM) 440 - 2

† 150 mm ↔ 440 mm
 ⚡ 6 x MAX 40W E 14

LAV - ZW - 6 (P) 440 - 2/R
 LAV - ZW - 6 (Z) 440 - 2/R
 LAV - ZW - 6 (N) 440 - 2/R
 LAV - ZW - 6 (BN) 440 - 2/R
 LAV - ZW - 6 (ZM) 440 - 2/R

† 700 mm - MIN 200 ↔ 440 mm
 ⚡ 6 x MAX 40W E 14

 (P) - PATYNA - PATINA - ПАТИНА
 (Z) - ZŁOTO - GOLD - ЗОЛОТО
 (N) - NIKIEL MATOWY - ANCIENT NICKEL - АНТИЧНЫЙ НИКЕЛЬ
 (BN) - BŁYSZCZĄCY NIKIEL - SHINY NICKEL - БЛИСТЯЩИЙ НИКЕЛЬ
 (ZM) - ZŁOTO MATOWE - MATT GOLD - МАТОВОЕ ЗОЛОТО



LAV-ZW-3 (Z) 310-1/R



LAV-ZW-6 (P) 440-1/R



LAV-ZW-3 (Z) 310-2/R

LAV-PLM-6 (P) 440-2



LAV-PLM-6 (P) 440-1

LAV-ZW-6 (P) 440-2/R



LAVONE



 K U T E K
 CLASSIC

LAV - ZW - 6 (P) 60/44
 LAV - ZW - 6 (N) 60/44
 LAV - ZW - 6 (Z) 60/44
 LAV - ZW - 6 (BN) 60/44
 LAV - ZW - 6 (ZM) 60/44
 ‡ 700 mm ↔ 600 mm
 ⚡ 6 x MAX 40W E 14

LAV - ZW - 10 (ZM) 60/44/31
 LAV - ZW - 10 (N) 60/44/31
 LAV - ZW - 10 (P) 60/44/31
 LAV - ZW - 10 (Z) 60/44/31
 LAV - ZW - 10 (BN) 60/44/31
 ‡ 700 mm ↔ 600 mm
 ⚡ 10 x MAX 40W E 14

 (P) - PATYNA - PATINA - ПАТИНА
 (Z) - ZŁOTO - GOLD - ЗОЛОТО
 (N) - NIKIEL MATOWY - ANCIENT NICKEL - АНТИЧНЫЙ НИКЕЛЬ
 (BN) - BŁYSZCZĄCY NIKIEL - SHINY NICKEL - БЛИСТЯЩИЙ НИКЕЛЬ
 (ZM) - ZŁOTO MATOWE - MATT GOLD - МАТОВОЕ ЗЛОТО

LAV-ZW-10 (ZM) 60/44/31



LAV-ZW-6 (P) 60/44



LAVONE



K U T E K
 CLASSIC

LEA - ZW - 10 (BN/A)

LEA - ZW - 10 (P/A)

LEA - ZW - 10 (Z/A)

LEA - ZW - 10 (N/A)

LEA - ZW - 10 (ZM/A)

± 700 mm ↔ 1020 mm

💡 10 x MAX 40W E 14

LEA - K - 1 (Z/A)

LEA - K - 1 (P/A)

LEA - K - 1 (N/A)

LEA - K - 1 (BN/A)

LEA - K - 1 (ZM/A)

± 570 mm ↔ 100 mm ↗ 180 mm

💡 1 x MAX 40W E 14

LEA - K - 2 (Z/A)

LEA - K - 2 (P/A)

LEA - K - 2 (N/A)

LEA - K - 2 (BN/A)

LEA - K - 2 (ZM/A)

± 570 mm ↔ 240 mm ↗ 170 mm

💡 2 x MAX 40W E 14

LEA - K - 1 (P/A) CL

LEA - K - 1 (N/A) CL

LEA - K - 1 (Z/A) CL

LEA - K - 1 (BN/A) CL

LEA - K - 1 (ZM/A) CL

± 410 mm ↔ 100 mm ↗ 260 mm

💡 1 x MAX 40W E 14

LEA - ZW - 6 (Z/A)

LEA - ZW - 6 (P/A)

LEA - ZW - 6 (N/A)

LEA - ZW - 6 (BN/A)

LEA - ZW - 6 (ZM/A)

± 700 mm ↔ 720 mm

💡 6 x MAX 40W E 14

LEA - ZW - 4 (BN/A)

LEA - ZW - 4 (P/A)

LEA - ZW - 4 (Z/A)

LEA - ZW - 4 (N/A)

LEA - ZW - 4 (ZM/A)

± 700 mm ↔ 720 mm

💡 4 x MAX 40W E 14

LEA - LG - 1 (Z/A)

LEA - LG - 1 (P/A)

LEA - LG - 1 (N/A)

LEA - LG - 1 (BN/A)

LEA - LG - 1 (ZM/A)

± 600 mm ↔ 180 mm

💡 1 x MAX 40W E 14

LEA - LS - 1 (P/A)

LEA - LS - 1 (Z/A)

LEA - LS - 1 (N/A)

LEA - LS - 1 (BN/A)

LEA - LS - 1 (ZM/A)

± 1800 mm ↔ 450 mm

💡 1 x MAX 60W E 27

	(P) - PATYNA - PATINA - ПАТИНА
	(Z) - ZŁOTO - GOLD - ЗОЛОТО
	(N) - NIKIEL MATOWY - ANCIENT NICKEL - АНТИЧНЫЙ НИКЕЛЬ
	(BN) - BŁYSZCZĄCY NIKIEL - SHINY NICKEL - БЛИСТЯЩИЙ НИКЕЛЬ
	(ZM) - ZŁOTO MATOWE - MATT GOLD - МАТОВОЕ ЗОЛОТО

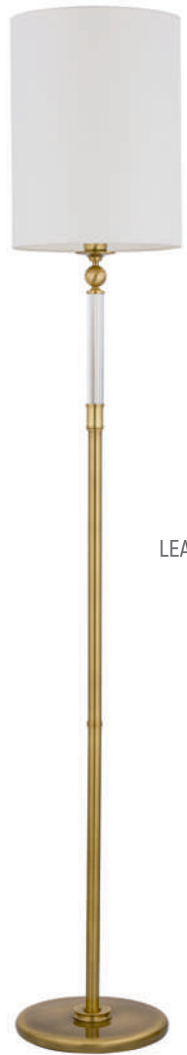

LEA-LS-1 (P/A)



LEA-ZW-4 (BN/A)



LEA-K-1 (Z/A)



LEA-ZW-6 (Z/A)



LEA-LG-1 (Z/A)



LEA-ZW-10 (BN/A)



LEA-K-1 (P/A) CL



LEA-K-2 (Z/A)

LEA



K U T E K
 CLASSIC

LEA - ZW - 12 (BN/A)

LEA - ZW - 12 (P/A)

LEA - ZW - 12 (Z/A)

LEA - ZW - 12 (N/A)

LEA - ZW - 12 (ZM/A)

± 700 mm ↔ 1020 mm

💡 12 x MAX 40W E 14

LEA - ZWM - 1 (Z/A)

LEA - ZWM - 1 (P/A)

LEA - ZWM - 1 (N/A)

LEA - ZWM - 1 (BN/A)

LEA - ZWM - 1 (ZM/A)

± MIN 700 mm ↔ 170 mm

💡 1 x MAX 40W E 14

LEA - ZWM - 1 (Z/A)

LEA - ZWM - 1 (P/A)

LEA - ZWM - 1 (N/A)

LEA - ZWM - 1 (BN/A)

LEA - ZWM - 1 (ZM/A)

± MIN 750 mm ↔ 175 mm

💡 1 x MAX 40W E 14

LEA - ZW - 8 (BN/A)

LEA - ZW - 8 (P/A)

LEA - ZW - 8 (N/A)

LEA - ZW - 8 (Z/A)

LEA - ZW - 8 (ZM/A)

± 700 mm ↔ 1020 mm

💡 8 x MAX 40W E 14

LEA - ZWM - 1 (BN/A)

LEA - ZWM - 1 (P/A)

LEA - ZWM - 1 (N/A)

LEA - ZWM - 1 (Z/A)

LEA - ZWM - 1 (ZM/A)

± MIN 700 mm ↔ 100 mm

💡 1 x MAX 40W E 14

- (P) - PATYNA - PATINA - ПАТИНА
- (Z) - ZŁOTO - GOLD - ЗОЛОТО
- (N) - NIKIEL MATOWY - ANCIENT NICKEL - АНТИЧНЫЙ НИКЕЛЬ
- (BN) - BŁYSZCZĄCY NIKIEL - SHINY NICKEL - БЛИСТАЩИЙ НИКЕЛЬ
- (ZM) - ZŁOTO MATOWE - MATT GOLD - МАТОВОЕ ЗОЛОТО



LEA-ZWM-1 (Z/A)



LEA-ZWM-1 (BN/A)



LEA-ZWM-1 (Z/A)



LEA-ZW-12 (BN/A)



LEA-ZW-8 (BN/A)

LEA



K U T E K
 CLASSIC

LID - ZWL - 3 (P) GR

LID - ZWL - 3 (P)

LID - ZWL - 3 (N)

LID - ZWL - 3 (N) GR

± 1200 mm ↔ 1400 mm x 340 mm

💡 3 x MAX 60W E 27

LID - LS - 1 (P) GR

LID - LS - 1 (P)

LID - LS - 1 (N)

LID - LS - 1 (N) GR

± 1830 mm ↔ 400 mm

💡 1 x MAX 60W E 27

LID - ZW - 2 (P) GR

LID - ZW - 2 (P)

LID - ZW - 2 (N)

LID - ZW - 2 (N) GR

± 1000 mm ↔ 880 mm x 340 mm

💡 2 x MAX 60W E 27

LID - LG - 1 (P) GR

LID - LG - 1 (P)

LID - LG - 1 (N)

LID - LG - 1 (N) GR

± 430 mm ↔ 290 mm

💡 1 x MAX 60W E 27

LID - K - 1 (P) GR

LID - K - 1 (P)

LID - K - 1 (N)

LID - K - 1 (N) GR

± 310 mm ↔ 240 mm ↗ 330 mm

💡 1 x MAX 60W E 27

■ (N) - NIKIEL MATOWY - ANCIENT NICKEL - АНТИЧНЫЙ НИКЕЛЬ
 ■ (P) - PATYNA - PATINA - ПАТИНА



LID-LS-1 (P) GR



LID-ZWL-3 (P) GR



LID-ZW-2 (P) GR

LID-K-1 (P) GR



LID-LG-1 (P) GR



LIDO



 K U T E K
 CLASSIC

LID - ZW - 5 (P)

LID - ZW - 5 (P) GR

LID - ZW - 5 (N)

LID - ZW - 5 (N) GR

‡ 870 mm ↔ 690 mm

💡 5 x MAX 60W E 27

LID - ZW - 1 (P)

LID - ZW - 1 (P) GR

LID - ZW - 1 (N)

LID - ZW - 1 (N) GR

‡ 760 mm ↔ 340 mm

💡 1 x MAX 60W E 27

LID - ZW - 3 (P)

LID - ZW - 3 (P) GR

LID - ZW - 3 (N)

LID - ZW - 3 (N) GR

‡ 870 mm ↔ 590 mm

💡 3 x MAX 60W E 27

LID - PL - 2 (P)

LID - PL - 2 (P) GR

LID - PL - 2 (N)

LID - PL - 2 (N) GR

‡ 200 mm ↔ 340 mm

💡 2 x MAX 60W E 27

■ (N) - NIKIEL MATOWY - ANCIENT NICKEL - АНТИЧНЫЙ НИКЕЛЬ
 ■ (P) - RATYNA - PATINA - ПАТИНА



LID-ZW-5 (P)



LID-ZW-3 (P)



LID-ZW-1 (P)



LID-PL-2 (P)

LIDO



K U T E K
 CLASSIC

LOR - ZW - 2 (P) 120/R
 LOR - ZW - 2 (N) 120/R
 LOR - ZW - 2 (Z) 120/R
 LOR - ZW - 2 (BN) 120/R
 LOR - ZW - 2 (ZM) 120/R

† 700 mm ↔ 130 mm
 ⚡ 2 x MAX 40W E 14

LOR - LG - 2 (P)
 LOR - LG - 2 (Z)
 LOR - LG - 2 (N)
 LOR - LG - 2 (BN)
 LOR - LG - 2 (ZM)

† 465 mm ↔ 160 mm
 ⚡ 2 x MAX 40W E 14

LOR - K - 2 (BN)
 LOR - K - 2 (P)
 LOR - K - 2 (N)
 LOR - K - 2 (Z)
 LOR - K - 2 (ZM)

† 540 mm ↔ 100 mm ↔ 120 mm
 ⚡ 2 x MAX 40W E 14

 (P) - PATYNA - PATINA - ПАТИНА
 (Z) - ZŁOTO - GOLD - ЗОЛОТО
 (N) - NIKIEL MATOWY - ANCIENT NICKEL - АНТИЧНЫЙ НИКЕЛЬ
 (BN) - BŁYSZCZĄCY NIKIEL - SHINY NICKEL - БЛИСТЯЩИЙ НИКЕЛЬ
 (ZM) - ZŁOTO MATOWE - MATT GOLD - МАТОВОЕ ЗЛОТО



LOR-K-2 (BN)



LOR-ZW-2 (P) 120/R



LOR-LG-2 (P)

LORETTO



K U T E K
 CLASSIC

LUC - ZW - 24 (N/A)

LUC - ZW - 24 (P/A)

± 1150 mm ↔ 1300 mm

💡 24 x MAX 40W E 14

LUC - ZW - 8 (P/A)

LUC - ZW - 8 (N/A)

± 800 mm ↔ 1100 mm

💡 8 x MAX 40W E 14

LUC - K - 2 (P/A)

LUC - K - 2 (N/A)

± 370 mm ↔ 380 mm ↗ 280 mm

💡 2 x MAX 40W E 14

LUC - K - 1 (N/A)

LUC - K - 1 (P/A)

± 350 mm ↔ 180 mm ↗ 300 mm

💡 1 x MAX 40W E 14

LUC - ZW - 6 (P/A)

LUC - ZW - 6 (N/A)

± 800 mm ↔ 950 mm

💡 6 x MAX 40W E 14

LUC - ZW - 12 (N/A)

LUC - ZW - 12 (P/A)

± 800 mm ↔ 1300 mm

💡 12 x MAX 40W E 14

LUC - LS - 3 (P/A)

LUC - LS - 3 (N/A)

± 1720 mm ↔ 530 mm

💡 3 x MAX 40W E 14

 (N) - NIKIEL MATOWY - ANCIENT NICKEL - АНТИЧНЫЙ НИКЕЛЬ
 (P) - RATYNA - PATINA - ПАТИНА

LUC-ZW-24 (N/A)



LUC-ZW-12 (N/A)



LUC-LS-3 (P/A)



LUC-K-2 (P/A)



LUC-K-1 (N/A)

LUCA



LUC-ZW-8 (P/A)



LUC-ZW-6 (P/A)



K U T E K
CLASSIC

MEL - ZW - 8 + 4 (ZM)

MEL - ZW - 8 + 4 (P)

MEL - ZW - 8 + 4 (N)

MEL - ZW - 8 + 4 (Z)

MEL - ZW - 8 + 4 (BN)

± 900 mm ↔ 800 mm

💡 12 x MAX 5W G 9

MEL - K - 1 (P)

MEL - K - 1 (N)

MEL - K - 1 (Z)

MEL - K - 1 (BN)

MEL - K - 1 (ZM)

± 260 mm ↔ 120 mm ↗ 140 mm

💡 1 x MAX 5W G 9

MEL - LG - 1 (P)

MEL - LG - 1 (Z)

MEL - LG - 1 (N)

MEL - LG - 1 (BN)

MEL - LG - 1 (ZM)

± 510 mm ↔ 130 mm

💡 1 x MAX 5W G 9

MEL - LS - 1 (ZM)

MEL - LS - 1 (N)

MEL - LS - 1 (P)

MEL - LS - 1 (Z)

MEL - LS - 1 (BN)

± 1600 mm ↔ 280 mm

💡 1 x MAX 5W G 9

MEL - ZW - 6 (P)

MEL - ZW - 6 (N)

MEL - ZW - 6 (Z)

MEL - ZW - 6 (ZM)

MEL - ZW - 6 (BN)

± 800 mm ↔ 710 mm

💡 6 x MAX 5W G 9

MEL - ZW - 3 (Z)

MEL - ZW - 3 (P)

MEL - ZW - 3 (N)

MEL - ZW - 3 (BN)

MEL - ZW - 3 (ZM)

± 700 mm ↔ 550 mm

💡 3 x MAX 5W G 9

MEL - ZW - 1 (P)

MEL - ZW - 1 (Z)

MEL - ZW - 1 (N)

MEL - ZW - 1 (BN)

MEL - ZW - 1 (ZM)

± 700 mm ↔ 120 mm

💡 1 x MAX 5W G 9

MEL - ZW - 8 (P)

MEL - ZW - 8 (N)

MEL - ZW - 8 (Z)

MEL - ZW - 8 (BN)

MEL - ZW - 8 (ZM)

± 700 mm ↔ 800 mm

💡 8 x MAX 5W G 9

- (P) - PATYNA - PATINA - ПАТИНА
- (Z) - ZŁOTO - GOLD - ЗОЛОТО
- (N) - NIKIEL MATOWY - ANCIENT NICKEL - АНТИЧНЫЙ НИКЕЛЬ
- (BN) - BŁYSZCZĄCY NIKIEL - SHINY NICKEL - БЛИСТЯЩИЙ НИКЕЛЬ
- (ZM) - ZŁOTO MATOWE - MATT GOLD - МАТОВОЕ ЗЛОТО



MEL-LS-1 (ZM)



MEL-ZW-8 (P)



MEL-ZW-6 (P)

MEL-ZW-8+4 (ZM)



MEL-ZW-1 (P)



MEL-ZW-3 (Z)

MELEZE



MEL-LG-1 (P)



MEL-K-1 (P)





K U T E K
 CLASSIC

MER - ZW - 8 (P/A)
 MER - ZW - 8 (Z/A)
 MER - ZW - 8 (N/A)
 MER - ZW - 8 (BN/A)
 MER - ZW - 8 (ZM/A)

† 700 mm ↔ 770 mm
 ⚡ 8 x MAX 40W E 14

MER - ZW - 6 (N/A)
 MER - ZW - 6 (P/A)
 MER - ZW - 6 (Z/A)
 MER - ZW - 6 (BN/A)
 MER - ZW - 6 (ZM/A)

† 700 mm ↔ 710 mm
 ⚡ 6 x MAX 40W E 14

MER - K - 1 (P/A)
 MER - K - 1 (Z/A)
 MER - K - 1 (N/A)
 MER - K - 1 (BN/A)
 MER - K - 1 (ZM/A)

† 390 mm ↔ 170 mm ↗ 190 mm
 ⚡ 1 x MAX 40W E 14

MER - ZW - 6 (P/A)
 MER - ZW - 6 (Z/A)
 MER - ZW - 6 (N/A)
 MER - ZW - 6 (BN/A)
 MER - ZW - 6 (ZM/A)

† 700 mm ↔ 710 mm
 ⚡ 6 x MAX 40W E 14

MER - LS - 1 (P/A)
 MER - LS - 1 (N/A)
 MER - LS - 1 (Z/A)
 MER - LS - 1 (BN/A)
 MER - LS - 1 (ZM/A)

† 1700 mm ↔ 450 mm
 ⚡ 1 x MAX 60W E 27

MER - LG - 1 (P/A) 300
 MER - LG - 1 (N/A) 300
 MER - LG - 1 (Z/A) 300
 MER - LG - 1 (BN/A) 300
 MER - LG - 1 (ZM/A) 300

† 650 mm ↔ 300 mm
 ⚡ 1 x MAX 60W E 27

■ (P) - PATYNA - PATINA - ПАТИНА
 ■ (Z) - ZŁOTO - GOLD - ЗОЛОТО
 ■ (N) - NIKIEL MATOWY - ANCIENT NICKEL - АНТИЧНЫЙ НИКЕЛЬ
 ■ (BN) - BŁYSZCZĄCY NIKIEL - SHINY NICKEL - БЛИСТЯЩИЙ НИКЕЛЬ
 ■ (ZM) - ZŁOTO MATOWE - MATT GOLD - МАТОВОЕ ЗОЛОТО



MER-LS-1 (P/A)



MER-ZW-6 (P/A)



MER-ZW-6 (N/A)



MER-LG-1 (P/A) 300



MER-K-1 (P/A)



MER-ZW-8 (P/A)

MERANO



K U T E K
 CLASSIC

MER - ZW - 6 (N)

MER - ZW - 6 (P)

MER - ZW - 6 (Z)

MER - ZW - 6 (BN)

MER - ZW - 6 (ZM)

± MIN 700 mm ↔ 690 mm

💡 6 x MAX 40W E 14

MER - K - 1 (N)

MER - K - 1 (P)

MER - K - 1 (Z)

MER - K - 1 (BN)

MER - K - 1 (ZM)

± 330 mm ↔ 100 mm ↔ 140 mm

💡 1 x MAX 40W E 14

MER - ZW - 8 (P)

MER - ZW - 8 (Z)

MER - ZW - 8 (N)

MER - ZW - 8 (BN)

MER - ZW - 8 (ZM)

± 700 mm ↔ 690 mm

💡 8 x MAX 40W E 14

MER - PL - 6 (P/A)

MER - PL - 6 (N/A)



MER - PL - 6 (Z/A)

MER - PL - 6 (BN/A)

MER - PL - 6 (ZM/A)

± MIN 430 mm ↔ 750 mm

💡 6 x MAX 40W E 14

 (P) - PATYNA - PATINA - ПАТИНА
 (Z) - ZŁOTO - GOLD - ЗОЛОТО
 (N) - NIKIEL MATOWY - ANCIENT NICKEL - АНТИЧНЫЙ НИКЕЛЬ
 (BN) - BŁYSZCZĄCY NIKIEL - SHINY NICKEL - БЛИСТЯЩИЙ НИКЕЛЬ
 (ZM) - ZŁOTO MATOWE - MATT GOLD - МАТОВОЕ ЗЛОТО



MER-ZW-8 (P)



MER-PL-6 (P/A)



MER-K-1 (N)



MER-ZW-6 (N)

MERANO



 K U T E K
 CLASSIC

MES - LG - 1 (P) GR

MES - LG - 1 (Z) GR

MES - LG - 1 (N) GR

± 600 mm ↔ 300 mm

💡 1x MAX 60W E 27

MES - LG - 1 (P)

MES - LG - 1 (Z)

MES - LG - 1 (N)

± 600 mm ↔ 300 mm

💡 1x MAX 60W E 27

■ (P) - PATYNA - PATINA - ПАТИНА
 ■ (Z) - ZŁOTO - GOLD - ЗОЛОТО
 ■ (N) - NIKIEL MATOWY - ANCIENT NICKEL - АНТИЧНЫЙ НИКЕЛЬ



MES-LG-1 (P) GR



MES-LG-1 (P)

MESSINA



K U T E K
CLASSIC

MON - ZWL - 8 (N/A)
MON - ZWL - 8 (P/A)
MON - ZWL - 8 (ZM/A)

↓ 750 mm
↔ 870 mm - 960 mm
↗ 870 mm
💡 8 x MAX 40W E 14

MON - ZW - 8 (P/A)
MON - ZW - 8 (N/A)
MON - ZW - 8 (ZM/A)

↓ 700 mm ↔ 850 mm
💡 8 x MAX 40W E 14

MON - K - 1 (P/A)
MON - K - 1 (N/A)
MON - K - 1 (ZM/A)

↓ 280 mm ↔ 180 mm ↗ 220 mm
💡 1 x MAX 40W E 14

MON - ZWL - 4 (P/A)
MON - ZWL - 4 (N/A)
MON - ZWL - 4 (ZM/A)

↓ 700 mm
↔ 1010 mm
↗ 400 mm
💡 4 x MAX 40W E 14

MON - ZW - 6 (N/A)
MON - ZW - 6 (P/A)
MON - ZW - 6 (ZM/A)

↓ 700 mm ↔ 850 mm
💡 6 x MAX 40W E 14

MON - LG - 1 (N/A)
MON - LG - 1 (P/A)
MON - LG - 1 (ZM/A)

↓ 490 mm
↔ 390 mm
↗ 210 mm
💡 1 x MAX 60W E 27

 (P) - PATYNA - PATINA - ПАТИНА
 (N) - NIKIEL MATOWY - ANCIENT NICKEL - АНТИЧНЫЙ НИКЕЛЬ
 (ZM) - ZŁOTO MATOWE - MATT GOLD - МАТОВОЕ ЗЛОТО



MON-ZWL-8 (N/A)



MON-ZW-6 (N/A)

MON-ZW-8 (P/A)



MONZA



MON-LG-1 (N/A)



MON-K-1 (P/A)

MON-ZWL-4 (P/A)





K U T E K
 CLASSIC

MON - ZW - 3 (P/A)

MON - ZW - 3 (N/A)

MON - ZW - 3 (ZM/A)

± 700 mm ↔ 550 mm

💡 3 x MAX 40W E 14

MON - K - 2 (P/A)

MON - K - 2 (N/A)

MON - K - 2 (ZM/A)

± 270 mm ↔ 470 mm ↗ 255 mm

💡 2 x MAX 40W E 14

MON - ZWD - 1 (P/A)

MON - ZWD - 1 (N/A)

MON - ZWD - 1 (ZM/A)

± 950 mm ↔ 300 mm

💡 1 x MAX 60W E 27

MON - ZWD - 3 (P/A)

MON - ZWD - 3 (N/A)

MON - ZWD - 3 (ZM/A)

± 700 mm ↔ 600 mm

💡 3 x MAX 40W E 14

MON - LS - 1 (P/A)

MON - LS - 1 (N/A)

MON - LS - 1 (ZM/A)

± 1760 mm ↔ 550 mm

💡 3 x MAX 40W E 14

 (P) - PATYNA - PATINA - ПАТИНА
 (N) - NIKIEL MATOWY - ANCIENT NICKEL - АНТИЧНЫЙ НИКЕЛЬ
 (ZM) - ZŁOTO MATOWE - MATT GOLD - МАТОВОЕ ЗЛОТО



MON-LS-1 (P/A)



MON-ZWD-3 (P/A)



MON-ZWD-1 (P/A)



MON-K-2 (P/A)



MONZA

MON-ZW-3 (P/A)



K U T E K
CLASSIC

N - ZW - 5 (P/A)
N - ZW - 5 (Z/A)
N - ZW - 5 (ZM/A)

± 550 mm ↔ 540 mm
💡 5 x MAX 40W E 14

N - K - 1 (P/A)
N - K - 1 (Z/A)
N - K - 1 (ZM/A)

± 250 mm ↔ 170 mm ↗ 290 mm
💡 1 x MAX 40W E 14

N - K - 2 (P/A)
N - K - 2 (Z/A)
N - K - 2 (ZM/A)

± 250 mm ↔ 420 mm ↗ 260 mm
💡 2 x MAX 40W E 14

N - ZW - 3 (P/A)
N - ZW - 3 (Z/A)
N - ZW - 3 (ZM/A)

± 550 mm ↔ 490 mm
💡 3 x MAX 40W E 14

N - ZW - 2 (P/A)
N - ZW - 2 (Z/A)
N - ZW - 2 (ZM/A)

± 550 mm ↔ 490 mm
💡 2 x MAX 40W E 14

N - LG - 1 (P/A)
N - LG - 1 (N/A)
N - LG - 1 (ZM/A)

± 360 mm ↔ 180 mm
💡 1 x MAX 40W E 14

 (P) - ПАТІНА - PATINA - ПАТИНА
 (Z) - ŻŁOTO - GOLD - ЗОЛОТО
 (ZM) - ŻŁOTO MATOWE - MATT GOLD - МАТОВОЕ ЗЛОТО



N-ZW-3 (P/A)

N-ZW-5 (P/A)



N-ZW-2 (P/A)



N-LG-1 (P/A)



N-K-1 (P/A)



N-K-2 (P/A)



K U T E K
 CLASSIC

N - ZW - 5 (P)
 N - ZW - 5 (Z)
 N - ZW - 5 (ZM)

† 570 mm ↔ 560 mm
 ⚡ 5 x MAX 60W E 27

N - ZW - 2 (P)
 N - ZW - 2 (Z)
 N - ZW - 2 (ZM)

† 540 mm ↔ 580 mm x 200 mm
 ⚡ 2 x MAX 60W E 27

N - K - 1 (P)
 N - K - 1 (Z)
 N - K - 1 (ZM)

† 250 mm ↔ 200 mm ↗ 300 mm
 ⚡ 1 x MAX 60W E 27

N - K - 2 (P)
 N - K - 2 (Z)
 N - K - 2 (ZM)

† 250 mm ↔ 410 mm ↗ 290 mm
 ⚡ 2 x MAX 60W E 27

N - ZW - 3 (P)
 N - ZW - 3 (Z)
 N - ZW - 3 (ZM)

† 540 mm ↔ 530 mm
 ⚡ 3 x MAX 60W E 27

N - PL - 2 (P)
 N - PL - 2 (Z)
 N - PL - 2 (ZM)

† 200 mm ↔ 340 mm
 ⚡ 2 x MAX 60W E 27

N - LG - 1 (P)
 N - LG - 1 (Z)
 N - LG - 1 (ZM)

† 370 mm ↔ 280 mm
 ⚡ 1 x MAX 60W E 27

N - LS - 3 (Z)
 N - LS - 3 (P)
 N - LS - 3 (ZM)

† 1600 mm ↔ 520 mm
 ⚡ 3 x MAX 60W E 27

(P) - ПАТІНА - PATINA - ПАТИНА
 (Z) - ЗЛІТО - GOLD - ЗОЛОТО
 (ZM) - ЗЛІТО МАТОВЕ - MATT GOLD - МАТОВОЕ ЗЛОТО

N-PL-2 (P)



N-ZW-3 (P)



N-ZW-5 (P)



N-K-1 (P)



N-LS-3 (Z)



N-LG-1 (P)



N-ZW-2 (P)



N-K-2 (P)





K U T E K
CLASSIC

NAP - ZW - 8 (Z/A)
NAP - ZW - 8 (P/A)
NAP - ZW - 8 (N/A)
NAP - ZW - 8 (BN/A)
NAP - ZW - 8 (ZM/A)

↓ 700 mm ↔ 770 mm
💡 8 x MAX 40W E 14

NAP - PL - 6 (P/A)
NAP - PL - 6 (Z/A)
NAP - PL - 6 (N/A)
NAP - PL - 6 (BN/A)
NAP - PL - 6 (ZM/A)

↓ 350 mm ↔ 780 mm
💡 6 x MAX 40W E 14

NAP - ZWD - 1 (P/A)
NAP - ZWD - 1 (Z/A)
NAP - ZWD - 1 (N/A)
NAP - ZWD - 1 (BN/A)
NAP - ZWD - 1 (ZM/A)

↓ MIN 850 mm ↔ 440 mm
💡 1 x MAX 60W E 27

NAP - K - 1 (P/A)
NAP - K - 1 (N/A)
NAP - K - 1 (Z/A)
NAP - K - 1 (BN/A)
NAP - K - 1 (ZM/A)

↓ 380 mm ↔ 150 mm ↗ 200 mm
💡 1 x MAX 40W E 14

NAP - ZW - 6 (N/A)
NAP - ZW - 6 (P/A)
NAP - ZW - 6 (Z/A)
NAP - ZW - 6 (BN/A)
NAP - ZW - 6 (ZM/A)

↓ 700 mm ↔ 730 mm
💡 6 x MAX 40W E 14

NAP - LS - 1 (N/A)
NAP - LS - 1 (P/A)
NAP - LS - 1 (Z/A)
NAP - LS - 1 (ZM/A)
NAP - LS - 1 (BN/A)

↓ 1700 mm ↔ 450 mm
💡 1 x MAX 60W E 27

NAP - LG - 1 (P/A) 300
NAP - LG - 1 (N/A) 300
NAP - LG - 1 (Z/A) 300
NAP - LG - 1 (BN/A) 300
NAP - LG - 1 (ZM/A) 300

↓ 660 mm ↔ 300 mm
💡 1 x MAX 60W E 27

- (P) - PATYNA - PATINA - ПАТИНА
- (Z) - ZŁOTO - GOLD - ЗОЛОТО
- (N) - NIKIEL MATOWY - ANCIENT NICKEL - АНТИЧНЫЙ НИКЕЛЬ
- (BN) - BŁYSZCZĄCY NIKIEL - SHINY NICKEL - БЛИСТЯЩИЙ НИКЕЛЬ
- (ZM) - ZŁOTO MATOWE - MATT GOLD - МАТОВОЕ ЗОЛОТО



NAP-LS-1 (N/A)



NAP-ZWD-1 (P/A)



NAP-ZW-6 (N/A)



NAP-PL-6 (P/A)



NAP-LG-1 (P/A) 300



NAP-K-1 (P/A)



NAP-ZW-8 (Z/A)

NAPOLI



 K U T E K
 CLASSIC

NIC - ZW - 10 (P/A)

NIC - ZW - 10 (N/A)

± 700 mm ↔ 860 mm

💡 10 x MAX 40W E 14

NIC - ZW - 6 (P/A)

NIC - ZW - 6 (N/A)

± 600 mm ↔ 660 mm

💡 6 x MAX 40W E 14

NIC - K - 1 (P/A)

NIC - K - 1 (N/A)

± 290 mm ↔ 180 mm ↗ 290 mm

💡 1 x MAX 40W E 14

NIC - K - 2 (P/A)

NIC - K - 2 (N/A)

± 290 mm ↔ 250 mm ↗ 260 mm

💡 2 x MAX 40W E 14

NIC - ZW - 8 (P/A)

NIC - ZW - 8 (N/A)

± 700 mm ↔ 700 mm

💡 8 x MAX 40W E 14

NIC - ZW - 5 (P/A)

NIC - ZW - 5 (N/A)

± 600 mm ↔ 620 mm

💡 5 x MAX 40W E 14

NIC - LS - 3 (P/A)

NIC - LS - 3 (N/A)

± 1720 mm ↔ 530 mm

💡 3 x MAX 40W E 14

NIC - LN - 1 (P/A)

NIC - LN - 1 (N/A)

± 510 mm ↔ 300 mm

💡 1 x MAX 60W E 27

 (P) - ПАТІНА - PATINA - ПАТИНА

 (N) - NIKIEL MATOWY - ANCIENT NICKEL - АНТИЧНЫЙ НИКЕЛЬ



NIC-LS-3 (P/A)



NIC-ZW-8 (P/A)

NIC-ZW-5 (P/A)



NIC-ZW-10 (P/A)

NIC-K-1 (P/A)



NICO



NIC-LN-1 (P/A)



NIC-K-2 (P/A)



NIC-ZW-6 (P/A)



 K U T E K
 CLASSIC

NIC - ZW - 10 (P)

NIC - ZW - 10 (N)

± 650 mm ↔ 800 mm

💡 10 x MAX 60W E 27

NIC - K - 2 (N)

NIC - K - 2 (P)

± 300 mm ↔ 360 mm ↗ 230 mm

💡 2 x MAX 60W E 27

NIC - K - 1 (P)

NIC - K - 1 (N)

± 300 mm ↔ 120 mm ↗ 260 mm

💡 1 x MAX 60W E 27

NIC - ZW - 6 (N)

NIC - ZW - 6 (P)

± 650 mm ↔ 600 mm

💡 6 x MAX 60W E 27

NIC - ZW - 5 (P)

NIC - ZW - 5 (N)

± 600 mm ↔ 600 mm

💡 5 x MAX 60W E 27

NIC - ZW - 1 (P)

NIC - ZW - 1 (N)

± 700 mm ↔ 120 mm

💡 1 x MAX 60W E 27

 (P) - ПАТУНА - PATINA - ПАТИНА
 (N) - NIKIEL MATOWY - ANCIENT NICKEL - АНТИЧНЫЙ НИКЕЛЬ

NIC-ZW-10 (P)



NIC-ZW-6 (N)



NIC-K-2 (N)



NIC-ZW-5 (P)



NIC-ZW-1 (P)



NIC-K-1 (P)



NICO



K U T E K
 CLASSIC

OBD - ZW - 5 (P)

OBD - ZW - 5 (Z)

OBD - ZW - 5 (N)

± 570 mm ↔ 560 mm

💡 5 x MAX 60W E 27

OBD - ZW - 2 (P)

OBD - ZW - 2 (Z)

OBD - ZW - 2 (N)

± 540 mm ↔ 580 mm x 200 mm

💡 2 x MAX 60W E 27

OBD - LS - 3 (Z)

OBD - LS - 3 (P)

OBD - LS - 3 (N)

± 1600 mm ↔ 520 mm

💡 3 x MAX 60W E 27

OBD - K - 2 (P)

OBD - K - 2 (Z)

OBD - K - 2 (N)

± 250 mm ↔ 410 mm ↗ 380 mm

💡 2 x MAX 60W E 27

OBD - K - 1 (P)

OBD - K - 1 (Z)

OBD - K - 1 (N)

± 250 mm ↔ 200 mm ↗ 300 mm

💡 1 x MAX 60W E 27

OBD - ZW - 3 (P)

OBD - ZW - 3 (Z)

OBD - ZW - 3 (N)

± 540 mm ↔ 530 mm

💡 3 x MAX 60W E 27

OBD - ZW - 1 (P)

OBD - ZW - 1 (Z)

OBD - ZW - 1 (N)

± 760 mm ↔ 300 mm

💡 1 x MAX 60W E 27

OBD - LG - 1 (P)

OBD - LG - 1 (Z)

OBD - LG - 1 (N)

± 500 mm ↔ 250 mm

💡 1 x MAX 60W E 27

OBD - PL - 2 (P)

OBD - PL - 2 (Z)

OBD - PL - 2 (N)

± 200 mm ↔ 340 mm

💡 2 x MAX 60W E 27

(P) - ПАТІНА - PATINA - ПАТИНА
 (Z) - ЗІЛОТО - GOLD - ЗОЛОТО
 (N) - НИКІЛ МАТОВИЙ - ANCIENT NICKEL - АНТИЧНИЙ НИКЕЛЬ



OBD



K U T E K
CLASSIC

OLZ - ZW - 8 (P)

OLZ - ZW - 8 (Z)

OLZ - ZW - 8 (N)

OLZ - ZW - 8 (BN)

OLZ - ZW - 8 (ZM)

± 700 mm ↔ 820 mm

💡 8 x MAX 40W E 14

OLZ - KD - 1 (P)

OLZ - KD - 1 (Z)

OLZ - KD - 1 (N)

OLZ - KD - 1 (BN)

OLZ - KD - 1 (ZM)

± 850 mm ↔ 120 mm ↗ 160 mm

💡 1 x MAX 40W E 14

OLZ - K - 1 (P)

OLZ - K - 1 (Z)

OLZ - K - 1 (N)

OLZ - K - 1 (BN)

OLZ - K - 1 (ZM)

± 280 mm ↔ 120 mm ↗ 200 mm

💡 1 x MAX 40W E 14

OLZ - ZW - 6 (P)

OLZ - ZW - 6 (Z)

OLZ - ZW - 6 (N)

OLZ - ZW - 6 (BN)

OLZ - ZW - 6 (ZM)

± 700 mm ↔ 820 mm

💡 6 x MAX 40W E 14

OLZ - ZW - 6 (BN)

OLZ - ZW - 6 (Z)

OLZ - ZW - 6 (N)

OLZ - ZW - 6 (P)

OLZ - ZW - 6 (ZM)

± 700 mm ↔ 820 mm

💡 6 x MAX 40W E 14

- (P) - ПАТІНА - PATINA - ПАТИНА
- (Z) - ЗОЛОТО - GOLD - ЗОЛОТО
- (N) - НИКІЛ МАТОВИЙ - ANCIENT NICKEL - АНТИЧНИЙ НИКЕЛЬ
- (BN) - БІЛІСЯЩАЮЧИЙ НИКІЛ - SHINY NICKEL - БЛІСЯЩИЙ НИКЕЛЬ
- (ZM) - ЗОЛОТО МАТОВЕ - MATT GOLD - МАТОВЕ ЗОЛОТО



OLZ-ZW-6 (P)



OLZ-ZW-8 (P)



OLZ-ZW-6 (BN)

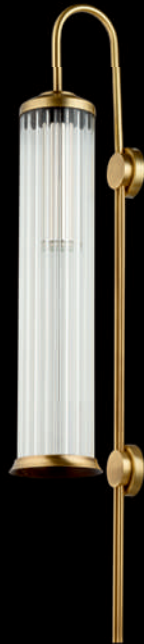

OLZ-KD-1 (P)



OLZ-K-1 (P)

OLZANO



K U T E K
CLASSIC

ORE - ZW - 8 (Z)
ORE - ZW - 8 (N)
ORE - ZW - 8 (P)
ORE - ZW - 8 (ZM)
ORE - ZW - 8 (BN)

± 700 mm ↔ 890 mm
💡 8 x MAX 40W E 14

ORE - K - 2 (ZM)
ORE - K - 2 (P)
ORE - K - 2 (N)
ORE - K - 2 (Z)
ORE - K - 2 (BN)

± 750 mm ↔ 500 mm ↗ 100 mm
💡 2 x MAX 40W E 14

ORE - ZW - 6 (P)
ORE - ZW - 6 (N)
ORE - ZW - 6 (Z)
ORE - ZW - 6 (ZM)
ORE - ZW - 6 (BN)

± 750 mm ↔ 860 mm
💡 6 x MAX 40W E 14

ORE - ZW - 2 (Z)
ORE - ZW - 2 (P)
ORE - ZW - 2 (N)
ORE - ZW - 2 (BN)
ORE - ZW - 2 (ZM)

± 700 mm ↔ 880 mm
💡 2 x MAX 40W E 14

- (P) - PATYNA - PATINA - ПАТИНА
- (Z) - ZŁOTO - GOLD - ЗОЛОТО
- (N) - NIKIEL MATOWY - ANCIENT NICKEL - АНТИЧНЫЙ НИКЕЛЬ
- (BN) - BŁYSZCZĄCY NIKIEL - SHINY NICKEL - БЛИСТЯЩИЙ НИКЕЛЬ
- (ZM) - ZŁOTO MATOWE - MATT GOLD - МАТОВОЕ ЗЛОТО

ORE-ZW-8 (Z)



ORE-ZW-2 (Z)



ORE-K-2 (ZM)



ORE-ZW-6 (P)



OREZZO



 K U T E K
 CLASSIC

ROM - ZW - 8+1 (P/A)

± 800 mm ↔ 950 mm

💡 8 x MAX 40W E 14

💡 3 x MAX 60W E 27

ROM - ZW - 6+1 (P/A)

± 700 mm ↔ 850 mm

💡 6 x MAX 40W E 14

💡 2 x MAX 60W E 27

ROM - K - 2 (P/A)

± 240 mm ↔ 380 mm ↗ 250 mm

💡 2 x MAX 40W E 14

ROM - LG - 1 (P/A)

± 530 mm ↔ 320 mm

💡 1 x MAX 60W E 27

ROM - K - 1 (P/A)

± 250 mm ↔ 180 mm ↗ 260 mm

💡 1 x MAX 40W E 14

 (P) - ПАТІНА - PATINA - ПАТИНА



ROM-ZW-8+1 (P/A)



ROM-ZW-6+1 (P/A)



ROM-LG-1 (P/A)



ROM-K-2 (P/A)



ROM-K-1 (P/A)

ROMA



K U T E K
 CLASSIC

ROM - ZW - 8+1 (P)

† 800 mm ↔ 950 mm
 ⚡ 11 x MAX 60W E 27

ROM - ZW - 3+1 (P)

† 700 mm ↔ 620 mm
 ⚡ 5 x MAX 60W E 27

ROM - K - 2 (P)

† 240 mm ↔ 410 mm ↗ 270 mm
 ⚡ 2 x MAX 60W E 27

ROM - K - 1 (P)

† 250 mm ↔ 200 mm ↗ 280 mm
 ⚡ 1 x MAX 60W E 27

ROM - ZW - 6+1 (P)

† 700 mm ↔ 850 mm
 ⚡ 8 x MAX 60W E 27

ROM - PLM - 3 (P)

† 220 mm ↔ 300 mm
 ⚡ 3 x MAX 60W E 27

ROM - LG - 1 (P)

† 510 mm ↔ 320 mm
 ⚡ 1 x MAX 60W E 27

ROM - LS - 3 (P)

† 1660 mm ↔ 500 mm
 ⚡ 3 x MAX 60W E 27

CUT GLASS

 (P) - РАТУНА - РАТИНА - ПАТИНА



ROM-LS-3 (P)

ROM-K-2 (P)



ROM-ZW-8+1 (P)



ROM-ZW-3+1 (P)



ROM-ZW-6+1 (P)



ROM-K-1 (P)



ROM-LG-1 (P)



ROM-PLM-3 (P)



ROMA

CUT GLASS



K U T E K
 CLASSIC

ROS - ZW - 8+4 (P/A)
 ROS - ZW - 8+4 (Z/A)
 ROS - ZW - 8+4 (N/A)
 ROS - ZW - 8+4 (BN/A)
 ROS - ZW - 8+4 (ZM/A)

† MIN 700 mm ↔ 1000 mm
 ⚡ 12 x MAX 40W E 14

ROS - ZW - 6 (BN/A)
 ROS - ZW - 6 (P/A)
 ROS - ZW - 6 (Z/A)
 ROS - ZW - 6 (N/A)
 ROS - ZW - 6 (ZM/A)

† MIN 700 mm ↔ 730 mm
 ⚡ 6 x MAX 40W E 14

ROS - LS - 1 (Z/A)
 ROS - LS - 1 (P/A)
 ROS - LS - 1 (N/A)
 ROS - LS - 1 (BN/A)
 ROS - LS - 1 (ZM/A)

† 1840 mm ↔ 450 mm
 ⚡ 1 x MAX 60W E 27

ROS - K - 1 (P/A)
 ROS - K - 1 (N/A)
 ROS - K - 1 (Z/A)
 ROS - K - 1 (BN/A)
 ROS - K - 1 (ZM/A)

† 330 mm ↔ 170 mm ↔ 230 mm
 ⚡ 1 x MAX 40W E 14

ROS - ZW - 8 (P/A)
 ROS - ZW - 8 (N/A)
 ROS - ZW - 8 (Z/A)
 ROS - ZW - 8 (BN/A)
 ROS - ZW - 8 (ZM/A)

† 700 mm ↔ 750 mm
 ⚡ 8 x MAX 40W E 14

ROS - PL - 6 (P/A)
 ROS - PL - 6 (N/A)
 ROS - PL - 6 (Z/A)
 ROS - PL - 6 (BN/A)
 ROS - PL - 6 (ZM/A)

† 350 mm ↔ 730 mm
 ⚡ 6 x MAX 40W E 14

ROS - LG - 1 (P/A)
 ROS - LG - 1 (N/A)
 ROS - LG - 1 (Z/A)
 ROS - LG - 1 (BN/A)
 ROS - LG - 1 (ZM/A)

† 670 mm ↔ 300 mm
 ⚡ 1 x MAX 60W E 27

(P) - ПАТІНА - PATINA - ПАТИНА
 (Z) - ЗОЛОТО - GOLD - ЗОЛОТО
 (N) - НИКІЛ МАТОВИЙ - ANCIENT NICKEL - АНТИЧНИЙ НИКЕЛЬ
 (BN) - БІЛІСЯЩІЙ НИКІЛ - SHINY NICKEL - БЛИСТЯЩИЙ НИКЕЛЬ
 (ZM) - МАТОВЕ ЗОЛОТО - MATT GOLD - МАТОВОЕ ЗОЛОТО



ROS-LS-1 (Z/A)



ROS-ZW-8+4 (P/A)



ROS-ZW-6 (BN/A)



ROS-PL-6 (P/A)



ROS-LG-1 (P/A)



ROS-K-1 (P/A)



ROS-ZW-8 (P/A)

ROSSANO



K U T E K
 CLASSIC

RUT - ZW - 6 (N/A)
 RUT - ZW - 6 (P/A)
 RUT - ZW - 6 (Z/A)
 RUT - ZW - 6 (BN/A)
 RUT - ZW - 6 (ZM/A)

† 700 mm ↔ 810 mm
 ⚡ 6 x MAX 40W E 14

RUT - LS - 1 (Z/A)
 RUT - LS - 1 (P/A)
 RUT - LS - 1 (N/A)
 RUT - LS - 1 (ZM/A)
 RUT - LS - 1 (BN/A)

† 1800 mm ↔ 300 mm
 ⚡ 1 x MAX 60W E 27

RUT - K - 1 (BN/A)
 RUT - K - 1 (P/A)
 RUT - K - 1 (N/A)
 RUT - K - 1 (Z/A)
 RUT - K - 1 (ZM/A)

† 570 mm ↔ 100 mm ↗ 180 mm
 ⚡ 1 x MAX 40W E 14

RUT - ZW - 3 (P/KL) TRA
 RUT - ZW - 3 (Z/KL) TRA
 RUT - ZW - 3 (N/KL) TRA
 RUT - ZW - 3 (BN/KL) TRA
 RUT - ZW - 3 (ZM/KL) TRA

† 700 mm ↔ 520 mm
 ⚡ 3 x MAX 40W E 14

RUT - LN - 1 (P/A)
 RUT - LN - 1 (Z/A)
 RUT - LN - 1 (N/A)
 RUT - LN - 1 (BN/A)
 RUT - LN - 1 (ZM/A)

† 615 mm ↔ 180 mm
 ⚡ 1 x MAX 40W E 14

 (P) - PATYNA - PATINA - ПАТИНА
 (Z) - ZŁOTO - GOLD - ЗОЛОТО
 (N) - NIKIEL MATOWY - ANCIENT NICKEL - АНТИЧНЫЙ НИКЕЛЬ
 (BN) - BŁYSZCZĄCY NIKIEL - SHINY NICKEL - БЛИСТЯЩИЙ НИКЕЛЬ
 (ZM) - ZŁOTO MATOWE - MATT GOLD - МАТОВОЕ ЗЛОТО



RUT-LS-1 (Z/A)



RUT-ZW-6 (N/A)



RUT-ZW-3 (P/KL) TRA



RUT-LN-1 (P/A)



RUT-K-1 (BN/A)

RUTA



K U T E K
 CLASSIC

RUT - ZW - 8 (Z/KL) TRA
 RUT - ZW - 8 (P/KL) TRA
 RUT - ZW - 8 (N/KL) TRA
 RUT - ZW - 8 (BN/KL) TRA
 RUT - ZW - 8 (ZM/KL) TRA

‡ 700 mm ↔ 1070 mm
 ⚡ 8 x MAX 40W E 14

RUT - K - 2 (BN/A)
 RUT - K - 2 (P/A)
 RUT - K - 2 (N/A)
 RUT - K - 2 (Z/A)
 RUT - K - 2 (ZM/A)

‡ 570 mm ↔ 240 mm ↗ 165 mm
 ⚡ 2 x MAX 40W E 14

RUT - K - 1 (Z/A)
 RUT - K - 1 (P/A)
 RUT - K - 1 (N/A)
 RUT - K - 1 (BN/A)
 RUT - K - 1 (ZM/A)



‡ 570 mm ↔ 100 mm ↗ 180 mm
 ⚡ 1 x MAX 40W E 14

RUT - ZWD - 1 (BN/A)
 RUT - ZWD - 1 (P/A)
 RUT - ZWD - 1 (N/A)
 RUT - ZWD - 1 (Z/A)
 RUT - ZWD - 1 (ZM/A)

‡ MIN 700 mm ↔ 180 mm
 ⚡ 1 x MAX 40W E 14

RUT - LG - 1 (P/A)
 RUT - LG - 1 (N/A)
 RUT - LG - 1 (Z/A)
 RUT - LG - 1 (BN/A)
 RUT - LG - 1 (ZM/A)

‡ 680 mm ↔ 250 mm x 180 mm
 ⚡ 1 x MAX 40W E 14

 (P) - PATYNA - PATINA - ПАТИНА
 (Z) - ZŁOTO - GOLD - ЗОЛОТО
 (N) - NIKIEL MATOWY - ANCIENT NICKEL - АНТИЧНЫЙ НИКЕЛЬ
 (BN) - BŁYSZCZĄCY NIKIEL - SHINY NICKEL - БЛИСТАЩИЙ НИКЕЛЬ
 (ZM) - ZŁOTO MATOWE - MATT GOLD - МАТОВОЕ ЗЛОТО



RUT-ZW-8 (Z/KL) TRA



RUT-ZWD-1 (BN/A)

RUTA



RUT-LG-1 (P/A)



RUT-K-2 (BN/A)



RUT-K-1 (Z/A)



K U T E K
CLASSIC

SAL - ZW - 8 (Z)

SAL - ZW - 8 (N)

SAL - ZW - 8 (P)

SAL - ZW - 8 (ZM)

SAL - ZW - 8 (BN)

± 1000 mm ↔ 760 mm

💡 16 x MAX 40W E 14

SAL - K - 2 (Z)

SAL - K - 2 (P)

SAL - K - 2 (N)

SAL - K - 2 (ZM)

SAL - K - 2 (BN)

± 390 mm ↔ 120 mm ↗ 110 mm

💡 2 x MAX 40W E 14

SAL - ZW - 6 (P)

SAL - ZW - 6 (N)

SAL - ZW - 6 (Z)

SAL - ZW - 6 (ZM)

SAL - ZW - 6 (BN)

± 960 mm ↔ 740 mm

💡 12 x MAX 40W E 14

SAL - LG - 2 (Z)

SAL - LG - 2 (P)

SAL - LG - 2 (N)

SAL - LG - 2 (BN)

SAL - LG - 2 (ZM)

± 565 mm ↔ 420 mm

💡 2 x MAX 40W E 14

(P) - PATYNA - PATINA - ПАТИНА
 (Z) - ZŁOTO - GOLD - ЗОЛОТО
 (N) - NIKIEL MATOWY - ANCIENT NICKEL - АНТИЧНЫЙ НИКЕЛЬ
 (BN) - BŁYSZCZĄCY NIKIEL - SHINY NICKEL - БЛИСТЯЩИЙ НИКЕЛЬ
 (ZM) - ZŁOTO MATOWE - MATT GOLD - МАТОВОЕ ЗЛОТО



SAL-ZW-8 (Z)



SAL-ZW-6 (P)



SAL-LG-2 (Z)



SAL-K-2 (Z)

SALETTO



K U T E K
 CLASSIC

SAN - ZW - 10 (P/A) CR
 SAN - ZW - 10 (Z/A) CR
 SAN - ZW - 10 (N/A) CR
 SAN - ZW - 10 (BN/A) CR
 SAN - ZW - 10 (ZM/A) CR

† 800 mm ↔ 860 mm
 ⚡ 10 x MAX 40W E 14

SAN - K - 1 (P/A) CR
 SAN - K - 1 (Z/A) CR
 SAN - K - 1 (N/A) CR
 SAN - K - 1 (BN/A) CR
 SAN - K - 1 (ZM/A) CR

† 230 mm ↔ 180 mm ↗ 290 mm
 ⚡ 1 x MAX 40W E 14

SAN - K - 2 (BN/A) CR
 SAN - K - 2 (P/A) CR
 SAN - K - 2 (N/A) CR
 SAN - K - 2 (Z/A) CR
 SAN - K - 2 (ZM/A) CR

† 310 mm ↔ 370 mm ↗ 250 mm
 ⚡ 2 x MAX 40W E 14

SAN - ZW - 8 (P/A) CR
 SAN - ZW - 8 (Z/A) CR
 SAN - ZW - 8 (N/A) CR
 SAN - ZW - 8 (BN/A) CR
 SAN - ZW - 8 (ZM/A) CR

† 700 mm ↔ 700 mm
 ⚡ 8 x MAX 40W E 14

SAN - LS - 1 (P/A) CR
 SAN - LS - 1 (Z/A) CR
 SAN - LS - 1 (N/A) CR
 SAN - LS - 1 (ZM/A) CR
 SAN - LS - 1 (BN/A) CR

† 1780 mm ↔ 530 mm
 ⚡ 1 x MAX 60W E 27

SAN - LG - 1 (P/A) CR
 SAN - LG - 1 (Z/A) CR
 SAN - LG - 1 (N/A) CR
 SAN - LG - 1 (BN/A) CR
 SAN - LG - 1 (ZM/A) CR

† 520 mm ↔ 300 mm
 ⚡ 1 x MAX 60W E 27

(P) - PATYNA - PATINA - ПАТИНА
 (Z) - ZŁOTO - GOLD - ЗОЛОТО
 (N) - NIKIEL MATOWY - ANCIENT NICKEL - АНТИЧНЫЙ НИКЕЛЬ
 (BN) - BŁYSZCZĄCY NIKIEL - SHINY NICKEL - БЛИСТЯЩИЙ НИКЕЛЬ
 (ZM) - ZŁOTO MATOWE - MATT GOLD - МАТОВОЕ ЗЛОТО



SAN-LS-1 (P/A) CR

SAN-ZW-10 (P/A) CR



SAN-K-1 (P/A) CR



SAN-K-2 (P/A) CR



SAN-LG-1 (P/A) CR



SAN-ZW-8 (P/A) CR

SAN MARINO



 K U T E K
 CLASSIC

SAN - ZW - 6 (P/A) CR
 SAN - ZW - 6 (Z/A) CR
 SAN - ZW - 6 (N/A) CR
 SAN - ZW - 6 (BN/A) CR
 SAN - ZW - 6 (ZM/A) CR

† 700 mm ↔ 650 mm
 ⚡ 6 x MAX 40W E 14

SAN - ZW - 2 (P/A) CR
 SAN - ZW - 2 (Z/A) CR
 SAN - ZW - 2 (N/A) CR
 SAN - ZW - 2 (ZM/A) CR
 SAN - ZW - 2 (BN/A) CR

† 700 mm ↔ 640 mm x 180 mm
 ⚡ 2 x MAX 40W E 14

SAN - ZW - 5 (Z/A) CR
 SAN - ZW - 5 (P/A) CR
 SAN - ZW - 5 (N/A) CR
 SAN - ZW - 5 (BN/A) CR
 SAN - ZW - 5 (ZM/A) CR

† 700 mm ↔ 640 mm
 ⚡ 5 x MAX 40W E 14

SAN - ZW - 3 (P/A) CR
 SAN - ZW - 3 (Z/A) CR
 SAN - ZW - 3 (N/A) CR
 SAN - ZW - 3 (BN/A) CR
 SAN - ZW - 3 (ZM/A) CR

† 700 mm ↔ 600 mm
 ⚡ 3 x MAX 40W E 14

 (P) - PATYNA - PATINA - ПАТИНА
 (Z) - ZŁOTO - GOLD - ЗОЛОТО
 (N) - NIKIEL MATOWY - ANCIENT NICKEL - АНТИЧНЫЙ НИКЕЛЬ
 (BN) - BŁYSZCZĄCY NIKIEL - SHINY NICKEL - БЛИСТЯЩИЙ НИКЕЛЬ
 (ZM) - ZŁOTO MATOWE - MATT GOLD - МАТОВОЕ ЗЛОТО



SAN-ZW-6 (P/A) CR



SAN-ZW-3(P/A) CR



SAN-ZW-2 (P/A) CR



SAN-ZW-5 (Z/A) CR

SAN MARINO



K U T E K
 CLASSIC

SAN - ZW - 8 (P) CR
 SAN - ZW - 8 (Z) CR
 SAN - ZW - 8 (N) CR
 SAN - ZW - 8 (BN) CR
 SAN - ZW - 8 (ZM) CR

† 700 mm ↔ 950 mm
 ⚡ 8 x MAX 60W E 27

SAN - ZW - 2 (P) CR
 SAN - ZW - 2 (Z) CR
 SAN - ZW - 2 (N) CR
 SAN - ZW - 2 (ZM) CR
 SAN - ZW - 2 (BN) CR

† 700 mm ↔ 690 mm x 250 mm
 ⚡ 2 x MAX 60W E 27

SAN - LS - 1 (Z) CR
 SAN - LS - 1 (P) CR
 SAN - LS - 1 (N) CR
 SAN - LS - 1 (BN) CR
 SAN - LS - 1 (ZM) CR

† 1770 mm ↔ 440 mm
 ⚡ 1 x MAX 60W E 27

SAN - K - 1 (P) CR
 SAN - K - 1 (Z) CR
 SAN - K - 1 (N) CR
 SAN - K - 1 (BN) CR
 SAN - K - 1 (ZM) CR

† 300 mm ↔ 250 mm ↔ 340 mm
 ⚡ 1 x MAX 60W E 27

SAN - ZW - 5 (Z) CR
 SAN - ZW - 5 (P) CR
 SAN - ZW - 5 (N) CR
 SAN - ZW - 5 (BN) CR
 SAN - ZW - 5 (ZM) CR

† 700 mm ↔ 690 mm
 ⚡ 5 x MAX 60W E 27

SAN - ZW - 3 (P) CR
 SAN - ZW - 3 (Z) CR
 SAN - ZW - 3 (N) CR
 SAN - ZW - 3 (BN) CR
 SAN - ZW - 3 (ZM) CR



† 700 mm ↔ 640 mm
 ⚡ 3 x MAX 60W E 27

SAN - LN - 1 (P) CR
 SAN - LN - 1 (Z) CR
 SAN - LN - 1 (N) CR
 SAN - LN - 1 (BN) CR
 SAN - LN - 1 (ZM) CR

† 520 mm ↔ 260 mm
 ⚡ 1 x MAX 60W E 27

SAN - LG - 1 (P) CR
 SAN - LG - 1 (Z) CR
 SAN - LG - 1 (N) CR
 SAN - LG - 1 (BN) CR
 SAN - LG - 1 (ZM) CR

† 510 mm ↔ 290 mm
 ⚡ 1 x MAX 60W E 27

 (P) - ПАТІНА - PATINA - ПАТИНА
 (Z) - ЗОЛОТО - GOLD - ЗОЛОТО
 (N) - NIKIEL MATOWY - ANCIENT NICKEL - АНТИЧНИЙ НИКЕЛЬ
 (BN) - BŁYSZCZĄCY NIKIEL - SHINY NICKEL - БЛИСТЯЩИЙ НИКЕЛЬ
 (ZM) - ZŁOTO MATOWE - MATT GOLD - МАТОВОЕ ЗЛОТО

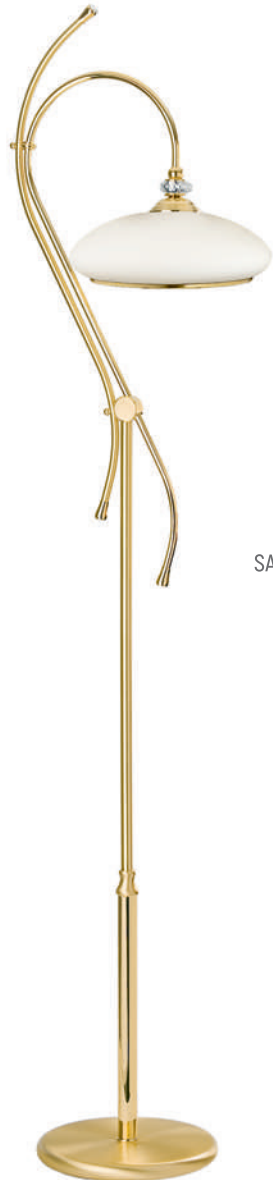

SAN-LS-1 (Z) CR



SAN-ZW-8 (P) CR

SAN-ZW-5 (Z) CR



SAN-ZW-3 (P) CR

SAN MARINO



SAN-LN-1 (P) CR



SAN-LG-1 (P) CR

SAN-ZW-2 (P) CR



SAN-K-1 (P) CR



 K U T E K
 CLASSIC

SIE - ZW - 10 (P)

SIE - ZW - 10 (N)

SIE - ZW - 10 (ZM)

± MIN 1000 mm ↔ 970 mm

💡 10 x MAX 60W E 27

💡 11 x MAX 40W E 14

SIE - ZW - 12 (P)

SIE - ZW - 12 (N)

SIE - ZW - 12 (ZM)

± MIN 1200 mm ↔ 1070 mm

💡 12 x MAX 60W E 27

💡 11 x MAX 40W E 14

 (P) - PATYNA - PATINA - ПАТИНА
 (N) - NIKIEL MATOWY - ANCIENT NICKEL - АНТИЧНЫЙ НИКЕЛЬ
 (ZM) - ZŁOTO MATOWE - MATT GOLD - МАТОВОЕ ЗЛОТО

SIE-ZW-10 (P)



SIE-ZW-12 (P)



SIENA



K U T E K
CLASSIC

SIE - ZW - 6 (P)

SIE - ZW - 6 (N)

SIE - ZW - 6 (ZM)

± MIN 1380 mm ↔ 750 mm

💡 6 x MAX 60W E27

💡 11 x MAX 40W E14

 (P) - PATYNA - PATINA - ПАТИНА
 (N) - NIKIEL MATOWY - ANCIENT NICKEL - АНТИЧНЫЙ НИКЕЛЬ
 (ZM) - ZŁOTO MATOWE - MATT GOLD - МАТОВОЕ ЗЛОТО



SIE-ZW-6 (P)

SIENA



K U T E K
CLASSIC

SIE - ZWD - 1 (P) 600

SIE - ZWD - 1 (N) 600

SIE - ZWD - 1 (ZM) 600

± MIN 1800 mm ↔ 600 mm

💡 14 x MAX 40W E 14

SIE - K - 1 (P)

SIE - K - 1 (N)

SIE - K - 1 (ZM)

± 370 mm ↔ 120 mm ↗ 280 mm

💡 1 x MAX 60W E 27

SIE - K - 2 (P)

SIE - K - 2 (N)

SIE - K - 2 (ZM)

± 370 mm ↔ 430 mm ↗ 240 mm

💡 2 x MAX 60W E 27

SIE - ZWD - 1 (P) 400

SIE - ZWD - 1 (N) 400

SIE - ZWD - 1 (ZM) 400

± MIN 1200 mm ↔ 400 mm

💡 11 x MAX 40W E 14

SIE - ZWD - 1 (N) 300

SIE - ZWD - 1 (P) 300

SIE - ZWD - 1 (ZM) 300

± MIN 1200 mm ↔ 300 mm

💡 11 x MAX 40W E 14

SIE - K - 3 (P)

SIE - K - 3 (N)

SIE - K - 3 (ZM)

± 370 mm ↔ 430 mm ↗ 370 mm

💡 3 x MAX 60W E 27

(P) - PATYNA - PATINA - ПАТИНА
 (N) - NIKIEL MATOWY - ANCIENT NICKEL - ANTIЧНЫЙ НИКЕЛЬ
 (ZM) - ZŁOTO MATOWE - MATT GOLD - МАТОВОЕ ЗЛОТО



SIE-ZWD-1 (N) 300



SIE-ZWD-1 (P) 400



SIE-ZWD-1 (P) 600



SIE-K-3 (P)



SIE-K-2 (P)



SIE-K-1 (P)

SIENA



K U T E K
CLASSIC

SIE - ZW - 20 (P)

SIE - ZW - 20 (N)

SIE - ZW - 20 (ZM)

± MIN 1800 mm ↔ 1900 mm

💡 34 x MAX 60W E 27

 (P) - PATYNA - PATINA - ПАТИНА
 (N) - NIKIEL MATOWY - ANCIENT NICKEL - АНТИЧНЫЙ НИКЕЛЬ
 (ZM) - ŻŁOTO MATOWE - MATT GOLD - МАТОВОЕ ЗЛОТО

SIE-ZW-20 (P)



SIENA



 K U T E K
 CLASSIC

SOR - ZWR - 1 (P)

† 700 mm ↔ 400 mm
 ⚡ 1 x MAX 60W E 27

SOR - LS - 1 (P)

† 1760 mm ↔ 400 mm
 ⚡ 1 x MAX 60W E 27

SOR - K - 1 (P)

† 300 mm ↔ 250 mm ↔ 350 mm
 ⚡ 1 x MAX 60W E 27

SOR - LG - 1 (P)

† 540 mm ↔ 290 mm
 ⚡ 1 x MAX 60W E 27

SOR - ZW - 1 (P)

† 700 mm ↔ 290 mm
 ⚡ 1 x MAX 60W E 27

SOR - LGR - 1 (P)

† 540 mm ↔ 300 mm
 ⚡ 1 x MAX 60W E 27

SOR - PL - 3 (P)

† 400 mm ↔ 410 mm
 ⚡ 3 x MAX 60W E 27

SOR - PLM - 3 (P)

† 200 mm ↔ 410 mm
 ⚡ 3 x MAX 60W E 27

WHITE GLASS

 (P) - ПАТІНА - PATINA - ПАТИНА



SORRENTO



K U T E K
 CLASSIC

SOR - ZW - 5 (P)

± 700 mm ↔ 700 mm
 ⚡ 5 x MAX 60W E 27

SOR - ZWD - 1 (P)

± 670 mm ↔ 400 mm
 ⚡ 3 x MAX 60W E 27

SOR - LG - 1 (P) GR

± 540 mm ↔ 290 mm
 ⚡ 1 x MAX 60W E 27

SOR - ZW - 3 (P)

± 700 mm ↔ 700 mm
 ⚡ 3 x MAX 60W E 27

SOR - LGR - 1 (P) GR

± 540 mm ↔ 300 mm
 ⚡ 1 x MAX 60W E 27

WHITE & GREEN GLASS

 (P) - РАТУНА - RATINA - ПАТИНА



SOR-ZW-5 (P)

SOR-ZWD-1 (P)

SOR-ZW-3 (P)

SOR-LGR-1 (P) GR

SOR-LG-1 (P) GR

SORRENTO



K U T E K
 CLASSIC

SPA - ZW - 8 (Z/A)

SPA - ZW - 8 (P/A)

SPA - ZW - 8 (N/A)

SPA - ZW - 8 (BN/A)

SPA - ZW - 8 (ZM/A)

± 700 mm ↔ 720 mm

💡 8 x MAX 40W E 14

SPA - ZW - 3 (N/A)

SPA - ZW - 3 (P/A)

SPA - ZW - 3 (Z/A)

SPA - ZW - 3 (BN/A)

SPA - ZW - 3 (ZM/A)

± 700 mm ↔ 690 mm

💡 3 x MAX 40W E 14

SPA - LS - 1 (P/A)

SPA - LS - 1 (Z/A)

SPA - LS - 1 (N/A)

SPA - LS - 1 (BN/A)

SPA - LS - 1 (ZM/A)

± 1800 mm ↔ 450 mm

💡 1 x MAX 60W E 27

SPA - K - 1 (N/A)

SPA - K - 1 (P/A)

SPA - K - 1 (N/A)

SPA - K - 1 (BN/A)

SPA - K - 1 (ZM/A)

± 310 mm ↔ 180 mm ↗ 255 mm

💡 1 x MAX 40W E 14

SPA - ZW - 6 (N/A)

SPA - ZW - 6 (P/A)

SPA - ZW - 6 (Z/A)

SPA - ZW - 6 (BN/A)

SPA - ZW - 6 (ZM/A)

± 700 mm ↔ 760 mm

💡 6 x MAX 40W E 14

SPA - ZWD - 1 (N/A)

SPA - ZWD - 1 (P/A)

SPA - ZWD - 1 (Z/A)

SPA - ZWD - 1 (ZM/A)

SPA - ZWD - 1 (BN/A)

± MIN 850 mm ↔ 450 mm

💡 1 x MAX 60W E 27

SPA - LG - 1 (P/A)

SPA - LG - 1 (Z/A)

SPA - LG - 1 (N/A)

SPA - LG - 1 (BN/A)

SPA - LG - 1 (ZM/A)

± 640 mm ↔ 300 mm

💡 1 x MAX 60W E 27

 (P) - PATYNA - PATINA - ПАТИНА
 (Z) - ZŁOTO - GOLD - ЗОЛОТО
 (N) - NIKIEL MATOWY - ANCIENT NICKEL - АНТИЧНЫЙ НИКЕЛЬ
 (BN) - BŁYSZCZĄCY NIKIEL - SHINY NICKEL - БЛИСТАЩИЙ НИКЕЛЬ
 (ZM) - ZŁOTO MATOWE - MATT GOLD - МАТОВОЕ ЗЛОТО



SPA-LS-1 (P/A)



SPA-ZW-6 (N/A)

SPA-ZWD-1 (N/A)



SPA-ZW-8 (Z/A)



SPARONE



SPA-LG-1 (P/A)

SPA-ZW-3 (N/A)



SPA-K-1 (NA)



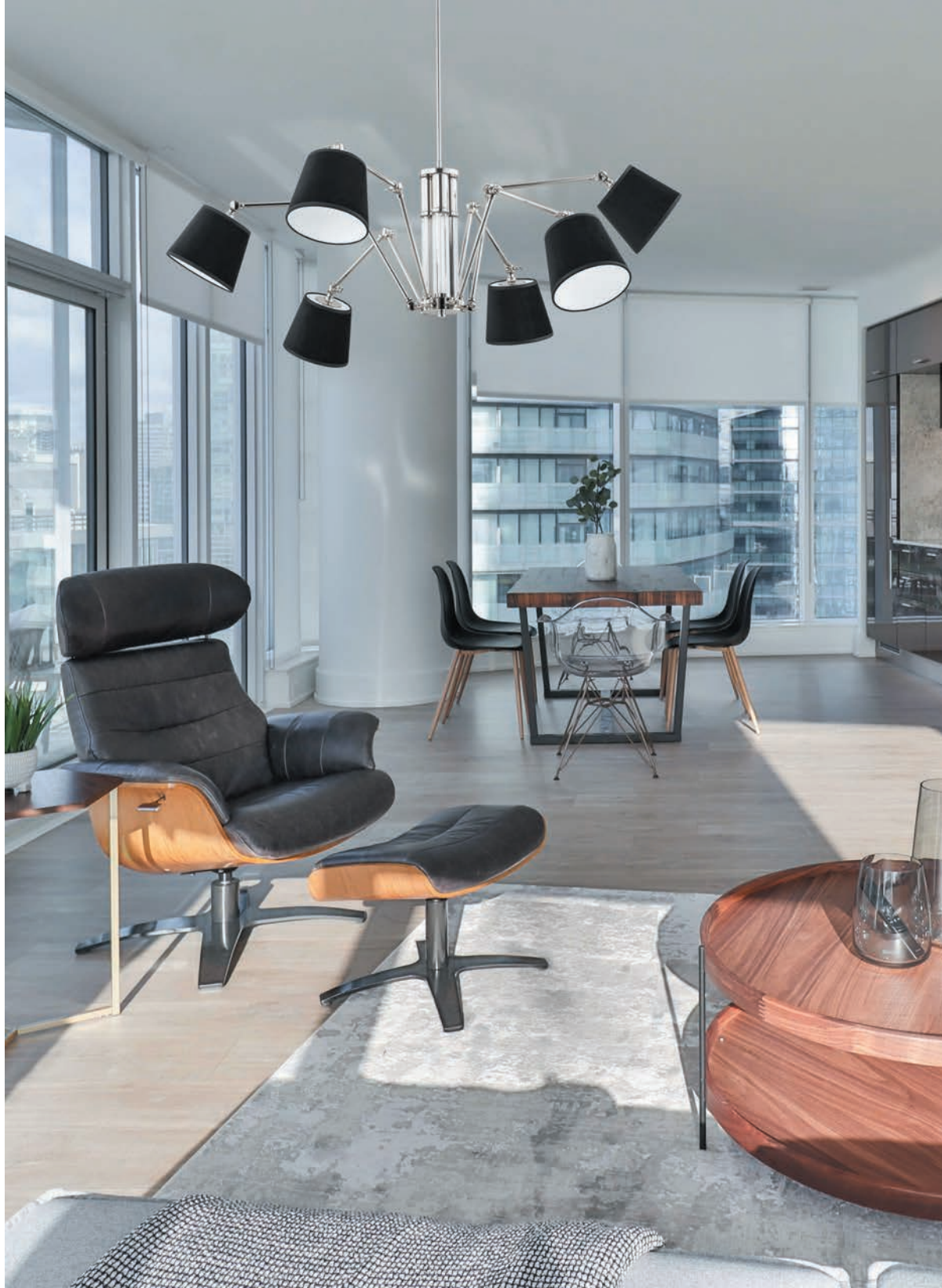

 K U T E K
 CLASSIC

TAD - ZW - 6 (BN/A)

TAD - ZW - 6 (P/A)

TAD - ZW - 6 (Z/A)

TAD - ZW - 6 (N/A)

TAD - ZW - 6 (ZM/A)

↓ MIN 700 mm ↔ 800 mm -1400 mm

💡 6 x MAX 40W E 14

TAD - K - 1 (P/A)

TAD - K - 1 (Z/A)

TAD - K - 1 (N/A)

TAD - K - 1 (BN/A)

TAD - K - 1 (ZM/A)

↓ 230 -350 mm ↔ 180 mm ↗ 330 -650

💡 1 x MAX 40W E 14

TAD - LG - 1 (P/A)

TAD - LG - 1 (N/A)

TAD - LG - 1 (Z/A)

TAD - LG - 1 (BN/A)

TAD - LG - 1 (ZM/A)

↓ 510 - 810 mm ↔ 370 - 650 mm

💡 1 x MAX 40W E 14

- (P) - PATYNA - PATINA - ПАТИНА
- (Z) - ZŁOTO - GOLD - ЗОЛОТО
- (N) - NIKIEL MATOWY - ANCIENT NICKEL - АНТИЧНЫЙ НИКЕЛЬ
- (BN) - BŁYSZCZĄCY NIKIEL - SHINY NICKEL - БЛИСТЯЩИЙ НИКЕЛЬ
- (ZM) - ZŁOTO MATOWE - MATT GOLD - МАТОВОЕ ЗЛОТО



TAD-ZW-6 (BN/A)



TAD-K-1 (P/A)



TAD-LG-1 (P/A)

TADEA



 K U T E K
 CLASSIC

TAM - ZW - 8 (Z/A)

TAM - ZW - 8 (N/A)

TAM - ZW - 8 (P/A)

TAM - ZW - 8 (BN/A)

TAM - ZW - 8 (ZM/A)

± 700 mm ↔ 860 mm

💡 8 x MAX 40W E 14

TAM - K - 1 (P/A)

TAM - K - 1 (Z/A)

TAM - K - 1 (N/A)

TAM - K - 1 (BN/A)

TAM - K - 1 (ZM/A)

± 425 mm ↔ 180 mm ↗ 200 mm

💡 1 x MAX 40W E 14

TAM - ZWD - 1 (N/A)

TAM - ZWD - 1 (Z/A)

TAM - ZWD - 1 (P/A)

TAM - ZWD - 1 (BN/A)

TAM - ZWD - 1 (ZM/A)

± MIN 900 mm ↔ 450 mm

💡 1 x MAX 60W E 27

TAM - ZW - 6 (N/A)

TAM - ZW - 6 (P/A)

TAM - ZW - 6 (Z/A)

TAM - ZW - 6 (BN/A)

TAM - ZW - 6 (ZM/A)

± 700 mm ↔ 820 mm

💡 6 x MAX 40W E 14

TAM - LS - 1 (P/A)

TAM - LS - 1 (N/A)

TAM - LS - 1 (Z/A)

TAM - LS - 1 (BN/A)

TAM - LS - 1 (ZM/A)

± 1770 mm ↔ 450 mm

💡 1 x MAX 60W E 27

TAM - LG - 1 (ZM/A)

TAM - LG - 1 (N/A)

TAM - LG - 1 (Z/A)

TAM - LG - 1 (P/A)

TAM - LG - 1 (BN/A)

± 565 mm ↔ 320 mm

💡 1 x MAX 60W E 27

- (P) - PATYNA - PATINA - ПАТИНА
- (Z) - ZŁOTO - GOLD - ЗОЛОТО
- (N) - NIKIEL MATOWY - ANCIENT NICKEL - АНТИЧНЫЙ НИКЕЛЬ
- (BN) - BŁYSZCZĄCY NIKIEL - SHINY NICKEL - БЛИСТЯЩИЙ НИКЕЛЬ
- (ZM) - ZŁOTO MATOWE - MATT GOLD - МАТОВОЕ ЗЛОТО



TAM-LS-1 (P/A)



TAM-ZW-8 (Z/A)

TAM-ZW-6 (N/A)



TAM-ZWD-1 (N/A)

TAMARA



TAM-LG-1 (ZM/A)



TAM-K-1 (P/A)





K U T E K
CLASSIC

URI - ZW - 6 (ZM)

URI - ZW - 6 (N)

URI - ZW - 6 (P)

URI - ZW - 6 (Z)

URI - ZW - 6 (BN)

± 780 mm ↔ 790 mm

💡 12 x MAX 40W E 14

URI - LG - 2 (Z)

URI - LG - 2 (N)

URI - LG - 2 (P)

URI - LG - 2 (ZM)

URI - LG - 2 (BN)

± 565 mm ↔ 420 mm

💡 2 x MAX 40W E 14

URI - K - 2 (Z)

URI - K - 2 (N)

URI - K - 2 (P)

URI - K - 2 (ZM)

URI - K - 2 (BN)

± 390 mm ↔ 120 mm ↔ 110 mm

💡 2 x MAX 40W E 14

- (P) - PATYNA - PATINA - ПАТИНА
- (Z) - ZŁOTO - GOLD - ЗОЛОТО
- (N) - NIKIEL MATOWY - ANCIENT NICKEL - АНТИЧНЫЙ НИКЕЛЬ
- (BN) - BEYSZCZĄCY NIKIEL - SHINY NICKEL - БЛИСТЯЩИЙ НИКЕЛЬ
- (ZM) - ZŁOTO MATOWE - MATT GOLD - МАТОВОЕ ЗЛОТО



URI-ZM-6 (ZM)



URI-K-2 (Z)



URI-LG-2 (Z)

URIA



K U T E K
 CLASSIC

USI - ZW - 6 (Z/A)
 USI - ZW - 6 (P/A)
 USI - ZW - 6 (N/A)
 USI - ZW - 6 (BN/A)
 USI - ZW - 6 (ZM/A)





† 700 mm ↔ 770 mm
 ⚡ 6 x MAX 40W E 14

USI - ZW - 8 (N)
 USI - ZW - 8 (P)
 USI - ZW - 8 (Z)
 USI - ZW - 8 (BN)
 USI - ZW - 8 (ZM)

† 700 mm ↔ 800 mm
 ⚡ 8 x MAX 40W E 14

USI - ZW - 6 (Z)
 USI - ZW - 6 (P)
 USI - ZW - 6 (N)
 USI - ZW - 6 (BN)
 USI - ZW - 6 (ZM)

† 700 mm ↔ 770 mm
 ⚡ 6 x MAX 40W E 14

 (P) - PATYNA - PATINA - ПАТИНА
 (Z) - ZŁOTO - GOLD - ЗОЛОТО
 (N) - NIKIEL MATOWY - ANCIENT NICKEL - АНТИЧНЫЙ НИКЕЛЬ
 (BN) - BŁYSZCZĄCY NIKIEL - SHINY NICKEL - БЛИСТЯЩИЙ НИКЕЛЬ
 (ZM) - ZŁOTO MATOWE - MATT GOLD - МАТОВОЕ ЗЛОТО



USI-ZW-6 (Z/A)



USI-ZW-8 (N)



USI-ZW-6 (Z)

USINI

VERA

160



K U T E K
CLASSIC

VER - LG - 1 (P/A) SZ - I
VER - LG - 1 (N/A) SZ - I
VER - LG - 1 (Z/A) SZ - I
VER - LG - 1 (BN/A) SZ - I
VER - LG - 1 (ZM/A) SZ - I

± 700 mm ↔ 320 mm
💡 1 x MAX 60W E 27

VER - LG - 1 (Z/A)
VER - LG - 1 (P/A)
VER - LG - 1 (N/A)
VER - LG - 1 (BN/A)
VER - LG - 1 (ZM/A)

± 740 mm ↔ 320 mm
💡 1 x MAX 60W E 27

VER - LG - 1 (ZM/A) SZ - II
VER - LG - 1 (P/A) SZ - II
VER - LG - 1 (Z/A) SZ - II
VER - LG - 1 (N/A) SZ - II
VER - LG - 1 (BN/A) SZ - II

± 700 mm ↔ 320 mm
💡 1 x MAX 60W E 27

(P) - PATYNA - PATINA - ПАТИНА
(Z) - ZŁOTO - GOLD - ЗОЛОТО
(N) - NIKIEL MATOWY - ANCIENT NICKEL - АНТИЧНЫЙ НИКЕЛЬ
(BN) - BŁYSZCZĄCY NIKIEL - SHINY NICKEL - БЛИСТЯЩИЙ НИКЕЛЬ
(ZM) - ZŁOTO MATOWE - MATT GOLD - МАТОВОЕ ЗЛОТО



VER-LG-1 (Z/A)



VER-LG-1 (P/A) SZ-I



VER-LG-1 (ZM/A) SZ-II

VERA



K U T E K
CLASSIC

ZAF - ZW - 8+4 (P/A)
ZAF - ZW - 8+4 (Z/A)
ZAF - ZW - 8+4 (N/A)
ZAF - ZW - 8+ 4(BN/A)
ZAF - ZW - 8+4 (ZM/A)

↓ MIN 900 mm ↔ 1120 mm
💡 12 x MAX 40W E 14

ZAF - ZW - 6 (Z/A)
ZAF - ZW - 6 (P/A)
ZAF - ZW - 6 (N/A)
ZAF - ZW - 6 (BN/A)
ZAF - ZW - 6 (ZM/A)

↓ 700 mm ↔ 850 mm
💡 6 x MAX 40W E 14

ZAF - LS - 1 (P/A)
ZAF - LS - 1 (Z/A)
ZAF - LS - 1 (N/A)
ZAF - LS - 1 (BN/A)
ZAF - LS - 1 (ZM/A)

↓ 1720 mm ↔ 400 mm
💡 1 x MAX 60W E 27

ZAF - K - 1 (P/A)
ZAF - K - 1 (N/A)
ZAF - K - 1 (Z/A)
ZAF - K - 1 (BN/A)
ZAF - K - 1 (ZM/A)

↓ 270 mm ↔ 180 mm ↗ 250 mm
💡 1 x MAX 40W E 14

ZAF - ZW - 8 (P/A)
ZAF - ZW - 8 (N/A)
ZAF - ZW - 8 (Z/A)
ZAF - ZW - 8 (BN/A)
ZAF - ZW - 8 (ZM/A)

↓ 700 mm ↔ 870 mm
💡 8 x MAX 40W E 14

ZAF - ZW - 2 (P/A)
ZAF - ZW - 2 (Z/A)
ZAF - ZW - 2 (N/A)
ZAF - ZW - 2 (ZM/A)
ZAF - ZW - 2 (BN/A)

↓ MIN 700 mm ↔ 990 mm
💡 2 x MAX 60W E 27

ZAF - LG - 1 (P/A)
ZAF - LG - 1 (Z/A)
ZAF - LG - 1 (N/A)
ZAF - LG - 1 (BN/A)
ZAF - LG - 1 (ZM/A)

↓ 470 mm ↔ 300 mm
💡 1 x MAX 60W E 27

■ (P) - PATYNA - PATINA - ПАТИНА
■ (Z) - ZŁOTO - GOLD - ЗОЛОТО
■ (N) - NIKIEL MATOWY - ANCIENT NICKEL - АНТИЧНЫЙ НИКЕЛЬ
■ (BN) - BŁYSZCZĄCY NIKIEL - SHINY NICKEL - БЛИСТЯЩИЙ НИКЕЛЬ
■ (ZM) - ZŁOTO MATOWE - MATT GOLD - МАТОВОЕ ЗЛОТО

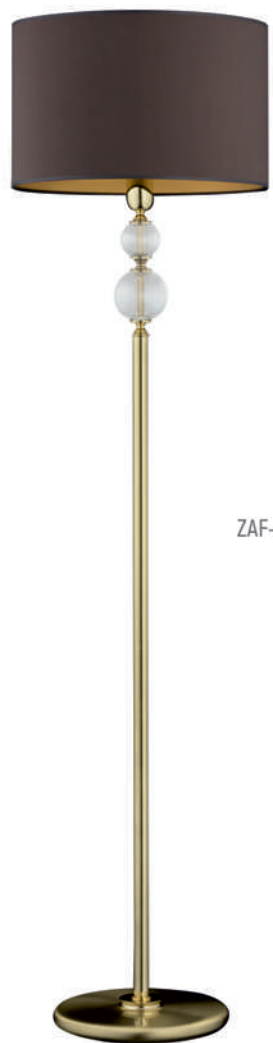

ZAF-LS-1 (P/A)



ZAF-ZW-8+4 (P/A)



ZAF-ZW-2 (P/A)



ZAF-ZW-6 (Z/A)



ZAF-LG-1 (P/A)



ZAF-ZW-8(P/A)



ZAF-K-1 (P/A)

ZAFFIRO



K U T E K
 CLASSIC

ZOL - ZW - 6 (N/A)

ZOL - ZW - 6 (P/A)

ZOL - ZW - 6 (Z/A)

ZOL - ZW - 6 (BN/A)

ZOL - ZW - 6 (ZM/A)

± 700 mm ↔ 680 mm

💡 6 x MAX 40W E 14

ZOL - K - 1 (P/A)

ZOL - K - 1 (Z/A)

ZOL - K - 1 (N/A)

ZOL - K - 1 (BN/A)

ZOL - K - 1 (ZM/A)

± 335 mm ↔ 210 mm ↔ 190 mm

💡 1 x MAX 40W E 14

ZOL - KD - 1 (BN/A)

ZOL - KD - 1 (P/A)

ZOL - KD - 1 (N/A)

ZOL - KD - 1 (Z/A)

ZOL - KD - 1 (ZM/A)

± 490 mm ↔ 200 mm ↔ 200 mm

💡 1 x MAX 40W E 14

ZOL - ZW - 3 (N/A)

ZOL - ZW - 3 (P/A)

ZOL - ZW - 3 (Z/A)

ZOL - ZW - 3 (BN/A)

ZOL - ZW - 3 (ZM/A)

± 700 mm ↔ 660 mm

💡 3 x MAX 40W E 14

ZOL - LG - 1 (Z/A)

ZOL - LG - 1 (P/A)

ZOL - LG - 1 (N/A)

ZOL - LG - 1 (ZM/A)

ZOL - LG - 1 (BN/A)

± 540 mm ↔ 320 mm

💡 1 x MAX 60W E 27

ZOL - LS - 1 (BN/A)

ZOL - LS - 1 (P/A)

ZOL - LS - 1 (Z/A)

ZOL - LS - 1 (BN/A)

ZOL - LS - 1 (ZM/A)

± 1750 mm ↔ 550 mm

💡 1 x MAX 60W E 27

- (P) - PATYNA - PATINA - ПАТИНА
- (Z) - ZŁOTO - GOLD - ЗОЛОТО
- (N) - NIKIEL MATOWY - ANCIENT NICKEL - АНТИЧНЫЙ НИКЕЛЬ
- (BN) - BŁYSZCZĄCY NIKIEL - SHINY NICKEL - БЛИСТЯЩИЙ НИКЕЛЬ
- (ZM) - ZŁOTO MATOWE - MATT GOLD - МАТОВОЕ ЗЛОТО



ZOL-LS-3 (BN/A)



ZOL-ZW-3 (BN/A)



ZOL-K-1 (P/A)



ZOL-KD-1 (BN/A)



ZOL-LG-1 (ZM/A)



ZOL-ZW-6 (N/A)

ZOLA

K	- KINKIET - WALL LAMP - БРА
K2	- PODWÓJNY KINKIET - DOUBLE WALL LAMP - ДВОЙНОЕ БРА
K3	- POTRÓJNY KINKIET - TRIPLE WALL LAMP - ТРОЙНОЙ БРА
LG	- LAMPA GABINETOWA - DESK LAMP - КАБИНЕТНАЯ ЛАМПА
LS	- LAMPA STOJĄCA - FLOOR LAMP - ТОРШЕР
PL	- PLAFON - PLAFOND - ПЛАФОНЕРА
PLM	- PLAFON - PLAFOND (CEILING) - ПЛАФОНЕРА (ПОТОЛОК)
ZW	- LAMPA WISZĄCA ŻYRANDOL - CHANDELIER - ЛЮСТРА
ZWM	- LAMPA WISZĄCA MAŁA - CHANDELIER (SMALL DIFFUSER) - ЛЮСТРА (МАЛЕНЬКИЙ ПЛАФОН)
ZWD	- LAMPA WISZĄCA DUŻA - CHANDELIER (LARGE DIFFUSER) - ЛЮСТРА (БОЛЬШОЙ ПЛАФОН)
ZWL	- LAMPA WISZĄCA W FORMIE LINII - CHANDELIER IN THE FORM OF THE LINE - ЛЮСТРА В ФОРМЕ ЛИНИИ
OCZ	- OCZKO PRZYSUFITOWE - MESH - ТОЧЕЧНЫЙ СВЕТИЛЬНИК
CR	- WERSJA LAMPY Z KRYSZTAŁEM - VERSION WITH CRISTALS - ВЕРСИЯ С КРИСТАЛЛАМИ
OZ	- PLAFON Z DEKORACJĄ NA KLOSZU - PLAFOND WITH DECORATION - ПЛАФОНЕРА С ДЕКОРОМ
A	- ABAŻURY - LAMPSHADES - АБАЖУРЫ
(/A)	- LAMPA Z ABAŻUREM - LAMPSHADES - АБАЖУРЫ
() A	- LAMPA Z KLOSZEM Z NADRUKIEM „ANIOŁY” - ANGELS - АНГЕЛЫ
() P	- KLOSZ PERŁOWY - PEARL LAMPSHADES - ЖЕМЧУЖИНА
() SR	- KLOSZ Z NADRUKIEM „SCENY RODZAJOWE” - SCENE - СЦЕНА
() GR	- KLOSZ ZIELONY - GREEN GLASS - ЗЕЛЕНЬКИЙ ПЛАФОН
() /R	- WERSJA LAMPY NA RURCE - LAMP VERSION ON THE TUBE - ЛАМПОВЫЙ ВАРИАНТ НА ТРУБКЕ
() 310	- SZEROKOŚĆ LAMPY - LAMP WIDTH - ШИРИНА ЛАМПЫ
() / -1	- JEDEN RZĄD RUREK - ONE ROW OF TUBES - ОДИН РЯД ТРУБОК
() 100	- ŚREDNICA SZPONKI KINKIETU - DIAMETER OF WALL LAMP CLAW - ДИАМЕТР ПЛАФОНА НАСТЕННОГО СВЕТИЛЬНИКА
() 105	- ŚREDNICA SZPONKI LAMPY - DIAMETER OF LAMP CLAW - ДИАМЕТР КОГТЯ ЛАМПЫ
CL	- WERSJA CLASSIC - CLASSIC VERSION - КЛАССИЧЕСКАЯ ВЕРСИЯ
PODS	- PODŚWIETLENIE / ILLUMINATION - ИЛЛЮМИНАЦИЯ
TRA	- TRANSPARENTNY - TRANSPARENT - ТРАНСПАРЕНТ

DESCRIPTION OF THE SYMBOLS
ОПИСАНИЕ СИМВОЛОВ

SYMBOLE KOLORU POWŁOK GALWANICZNYCH
COLOUR SYMBOLS FOR GALVANIC COATINGS
ЦВЕТОВЫЕ СИМВОЛЫ ДЛЯ ГАЛЬВАНИЧЕСКИХ ПОКРЫТИЙ

(P)	- PATYNA - PATINA - ПАТИНА
(Z)	- ZŁOTO - GOLD - ЗОЛОТО
(N)	- NIKIEL MATOWY - ANCIENT NICKEL - АНТИЧНЫЙ НИКЕЛЬ
(BN)	- WŁYSZCZĄCY NIKEL - SHINY NICKEL - БЛЕСТЯЩИЙ НИКЕЛЬ
(ZM)	- ZŁOTO MATOWE - MATT GOLD - МАТОВОЕ ЗОЛОТО

INDEX

AREZZO 9



AREZZO 9



AVERNO 11



AVERNO 11



AVERNO 11



AVERNO 11



AVERNO 11



AVERNO 11



BACCARA 13



BACCARA 13



BARI 15



BARI 15



BARI 15



BARI 15



BARI 15



BARI 15



BARI 15



BARI 15



BELLAGIO 17



BELLAGIO 17



BELLAGIO 17



BELLAGIO 17



BELLAGIO 17



BELLAGIO 17



BELLAGIO 17



BELLAGIO 19



BELLAGIO 19



BELLAGIO 19



BELLAGIO MODERN 21 BELLAGIO MODERN 21



BIBIONE 23

BIBIONE 23

BIBIONE 23



BIBIONE 23

BIBIONE 23



CARINO 25

BIBIONE 23



CARINO 25

BIBIONE 23



CARINO 25

BIBIONE 23



CARINO 25



CARINO 25



CARINO 25



CARINO 25



CARINO 25



CASAMIA 27



CASAMIA 27



CASAMIA 27



CASAMIA 27



CASAMIA 27



CASAMIA 27



CASAMIA 27



CASAMIA 27



CASAMIA 29



CASAMIA 29



INDEX

CASAMIA 29



CASAMIA 29



CASAMIA 29



CASAMIA 29



COCO 31



COCO 31



COCO 31



COCO 31



COCO 33



COCO 33



COCO 33



COCO 33



COCO 33



COCO ACCENT LIGHT 35



COCO ACCENT LIGHT 35



COCO ACCENT LIGHT 35



COCO ACCENT LIGHT 35



COCO ACCENT LIGHT 35



COCO ACCENT LIGHT 35



COCO ACCENT LIGHT 37



COCO ACCENT LIGHT 37



COCO ACCENT LIGHT 37



COCO ACCENT LIGHT 37



COCO ACCENT LIGHT 37



COCO ACCENT LIGHT 37



DECOR 39



DECOR 39



DECOR 39



DECOR 39



DECOR 39



DECOR 39



DECOR 41



DECOR 41



DECOR 41



DECOR 41



DECOR 41



DECOR 41



DECOR 41



DECOR 41



DIMARO 43



DIMARO 43



DIMARO 43



DIMARO 43



DIMARO 43



DIMARO 43



DIMARO 45



DIMARO 45



DIMARO 45



DIMARO 45



DIMARO 45



DIMARO 45



DIMARO 45



DORATO 47



DORATO 47



DORATO 47



DORATO 47



INDEX

DORATO 47



DORATO 47



ELLINI 49



ELLINI 49



ELLINI 49



ELLINI 49



ELLINI 49



ELLINI 49



ELLINI 51



ELLINI 51



ELLINI 51



ELLINI 51



ELVE 53



ELVE 53



ELVE 53



ELVE 53



ELVE 53



FARINI 55



FARINI 55



FARINI 55



FARINI 55



FARINI 55



FARINI 55



FARINI 55



FELLINO 57



FELLINO 57



FELLINO 57



FELLINO 57



FELLINO 57



FELLINO 57



FELLINO 59



FELLINO 59



FELLINO 59



FELLINO 59



FELLINO 59



FELLINO 59



FILAGO 61



FILAGO 61



FILAGO 61



FILAGO 61



FILAGO 61



FILAGO 61



FILAGO 61



FILAGO 61



FILAGO 63



FILAGO 63



FILAGO 63



FILAGO 63



FILAGO 63



FILAGO 63



FIORE 65



FIORE 65



FIORE 65



FIORE 65



FIORE 65



FIORE 65



INDEX

FIORE 67



FIORE 67



FIORE 67



FIORE 67



FIORE 67



FIORE 67



GENOVA 69



GENOVA 69



GENOVA 69



GENOVA 69



GENOVA 69



GENOVA 69



KAMMA 71



KAMMA 71



KAMMA 71



LAURIA 73



LAURIA 73



LAURIA 73



LAURIA 73



LAURIA 73



LAURIA 73



LAVONE 75



LAVONE 75



LAVONE 75



LAVONE 75



LAVONE 75



LAVONE 75



LAVONE 77



LAVONE 77



LEA 81

LAVONE 77



LEA 81

LAVONE 77



LEA 81

LAVONE 77



LEA 81

LAVONE 77



LEA 81

LAVONE 79



LEA 81

LAVONE 79



LEA 81



LEA 81



LEA 83



LEA 83



LEA 83



LEA 83



LEA 83



LIDO 85



LIDO 85



LIDO 85



LIDO 85



LIDO 85



LIDO 87



LIDO 87



LIDO 87



INDEX

LIDO 87



LUCA 91

LORETTO 89



LUCA 91

LORETTO 89



LUCA 91

LORETTO 89



LUCA 91

LUCA 91



MELEZE 93

LUCA 91



MELEZE 93

LUCA 91



MELEZE 93



MELEZE 93



MELEZE 93



MELEZE 93



MELEZE 93



MELEZE 93



MERANO 95



MERANO 95



MERANO 95



MERANO 95



MERANO 95



MERANO 95



MERANO 97



MERANO 97



MERANO 97



MERANO 97



MESSINA 99



MESSINA 99



MONZA 101



MONZA 101



MONZA 101



MONZA 101



MONZA 101



MONZA 101



MONZA 103



MONZA 103



MONZA 103



MONZA 103



MONZA 103



N 105



N 105



N 105



N 105



N 105



N 105



N 107



N 107



N 107



N 107



N 107



N 107



N 107



N 107



NAPOLI 109



NAPOLI 109



NAPOLI 109



NAPOLI 109



NAPOLI 109



NAPOLI 109



NAPOLI 109



NICO 111



NICO 111



NICO 111



NICO 111



NICO 111



NICO 111



NICO 111



NICO 113



NICO 113



NICO 113



NICO 113



NICO 113



NICO 113



NICO 113



OBD 115



OBD 115



OBD 115



OBD 115



OBD 115



OBD 115



OBD 115



OBD 115



OBD 115



OLZANO 117



OLZANO 117



OLZANO 115



OLZANO 115



OLZANO 115



OREZZO 119



OREZZO 119



OREZZO 119



OREZZO 119



ROMA 121



ROMA 121



ROMA 121



ROMA 121



ROMA 121



ROMA 123



ROMA 123



ROMA 123



ROMA 123



ROMA 123



ROMA 123



ROMA 123



ROMA 123



ROSSANO 125



ROSSANO 125



ROSSANO 125



ROSSANO 125



INDEX

ROSSANO 125



ROSSANO 125



ROSSANO 125



RUTA 127



RUTA 127



RUTA 127



RUTA 127



RUTA 127



RUTA 129



RUTA 129



RUTA 129



RUTA 129



RUTA 129



SALETTO 131



SALETTO 131



SALETTO 131



SALETTO 131



SAN MARINO 133



SAN MARINO 133



SAN MARINO 133



SAN MARINO 133



SAN MARINO 133



SAN MARINO 133



SAN MARINO 135



SAN MARINO 135



SAN MARINO 135



SAN MARINO 135



SAN MARINO 137



SAN MARINO 137



SAN MARINO 137



SAN MARINO 137



SAN MARINO 137



SAN MARINO 137



SAN MARINO 137



SAN MARINO 137



SIENA 139



SIENA 139



SIENA 141



SIENA 143



SIENA 143



SIENA 143



SIENA 143



SIENA 143



SIENA 143



SIENA 145



SORRENTO 147



SORRENTO 147



SORRENTO 147



SORRENTO 147



SORRENTO 147



SORRENTO 147



SORRENTO 147



SORRENTO 147



SORRENTO 149



SORRENTO 149



SORRENTO 149



INDEX

SORRENTO 149



SORRENTO 149



SPARONE 151



SPARONE 151



SPARONE 151



SPARONE 151



SPARONE 151



SPARONE 151



SPARONE 151



TADEA 153



TADEA 153



TADEA 153



TAMARA 155



TAMARA 155



TAMARA 155



TAMARA 155



TAMARA 155



TAMARA 155



URIA 157



URIA 157



URIA 157



USINI 159



USINI 159



USINI 159



VERA 161



VERA 161



VERA 161



ZAFFIRO 163



ZAFFIRO 163



ZAFFIRO 163



ZAFFIRO 163



ZAFFIRO 163



ZAFFIRO 163



ZAFFIRO 163



ZOLA 165



ZOLA 165



ZOLA 165



ZOLA 165



ZOLA 165













ZOLA 165



1.	AREZZO	9.	34.	NAPOLI	109.
2.	AVERNO	11.	35.	NICO	111.
3.	BACCARA	13.	36.	OBD	115.
4.	BARI	15.	37.	OLZANO	117.
5.	BELLAGIO	17.	38.	OREZZO	119.
6.	BELLAGIO MODERN	19.	39.	ROMA	121.
7.	BIBIONE	23.	40.	ROSSANO	125.
8.	CARINO	25.	41.	RUTA	127.
9.	CASAMIA	27.	42.	SALETTO	131.
10.	COCO	31.	43.	SAN MARINO	133.
11.	COCO ACCENT LIGHT	35.	44.	SIENA	139.
12.	DECOR	39.	45.	SORRENTO	147.
13.	DIMARO	45.	46.	SPARONE	151.
14.	DORATO	47.	47.	TADEA	153.
15.	ELLINI	49.	48.	TAMARA	155.
16.	ELVE	53.	49.	URIA	157.
17.	FARINI	55.	50.	USINI	159.
18.	FELLINO	57.	51.	VERA	161.
19.	FILAGO	61.	52.	ZAFFIRO	163.
20.	FIORE	65.	53.	ZOLA	165.
21.	GENOVA	69.			
22.	KAMMA	71.			
23.	LAURIA	73.			
24.	LAVONE	75.			
25.	LEA	81.			
26.	LIDO	85.			
27.	LORETTO	89.			
28.	LUCA	90.			
29.	MELEZE	93.			
30.	MERANO	95.			
31.	MESSINA	98.			
32.	MONZA	100.			
33.	N	105.			

INDEX

[P]		
[Z]		
[N]		
[BN]		
[ZM]		

AVAILABLE COLOURS FOR PLATING
ДОСТУПНЫЕ ЦВЕТА ГАЛЬВАНИЧЕСКИХ ПОКРЫТИЙ



PATYNA - PATINA - ПАТИНА

ZŁOTO - GOLD - ЗОЛОТО

NIKIEL MATOWY - ANCIENT NICKEL - АНТИЧНЫЙ НИКЕЛЬ

BŁYSZCZĄCY NIKIEL - SHINY NICKEL - БЛИСТЯЩИЙ НИКЕЛЬ

ZŁOTO MATOWE - MATT GOLD - МАТОВОЕ ЗЛОТО

DOSTĘPNE WYMIARY ABAŻURÓW

AVAILABLE DIMENSIONS OF LAMPSHADES

ДОСТУПНЫЕ РАЗМЕРЫ АБАЖУРОВ

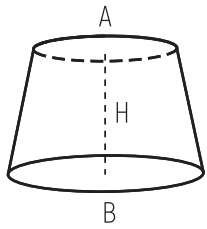

0

A = 90
B = 175
H = 110

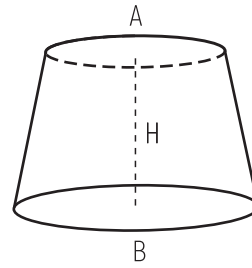

1

A = 120
B = 170
H = 140

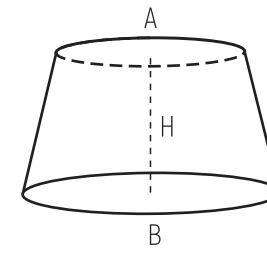

2

A = 150
B = 170
H = 120

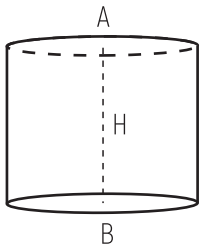

3

A = 175
B = 175
H = 120

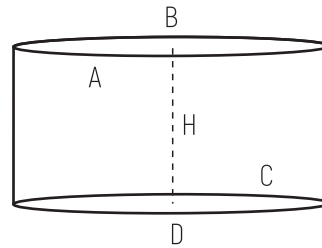

5

A = 120
B = 370
C = 250
D = 390
H = 150

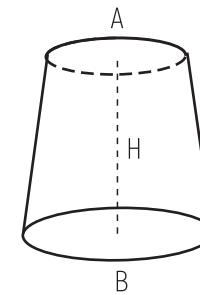

6

A = 100
B = 150
H = 160

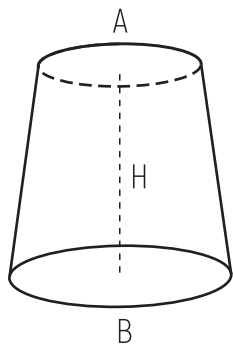

7

A = 130
B = 170
H = 200

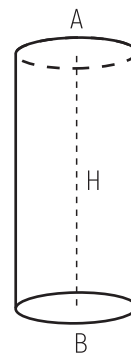

8

A = 100
B = 100
H = 190

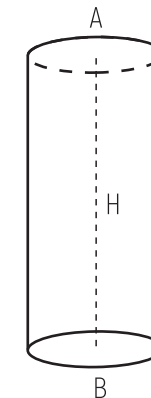

9

A = 120
B = 120
H = 210

ŻYRANDOL / CHANDELIER / ЛЮСТРА

KINKIET / WALL LAMP / БРА

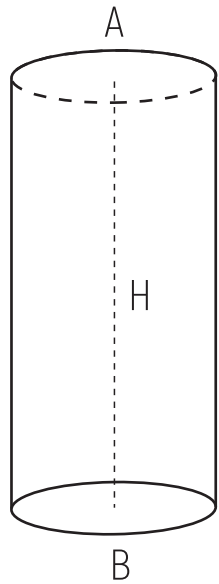

10
A = 180
B = 180
H = 300

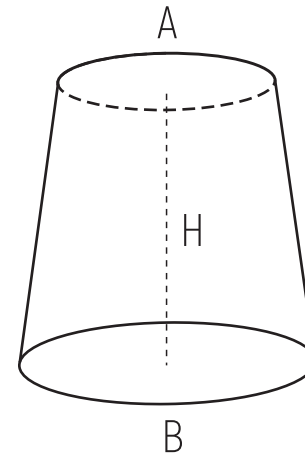

11
A = 180
B = 300
H = 270

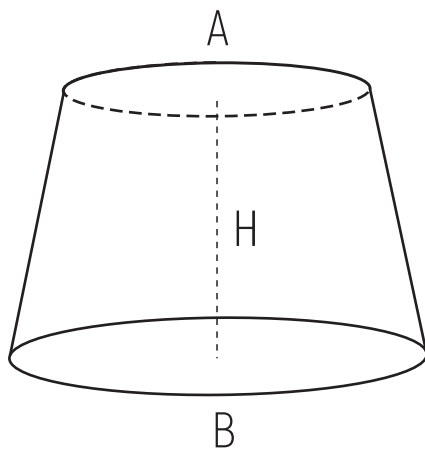

12
A = 300
B = 450
H = 400

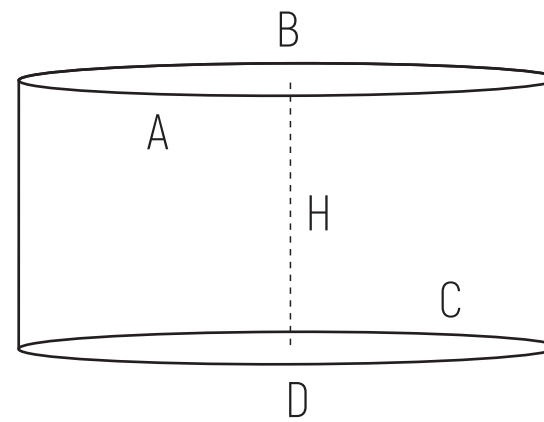

13
A = 550
B = 600
H = 300

DOSTĘPNE WYMIARY ABAŻURÓW

AVAILABLE DIMENSIONS OF LAMP SHADES

ДОСТУПНЫЕ РАЗМЕРЫ АБАЖУРОВ

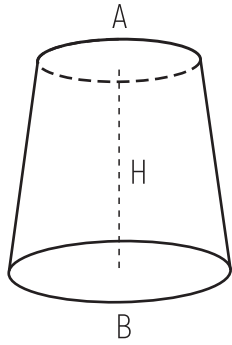

LG-N

A = 180
B = 300
H = 270

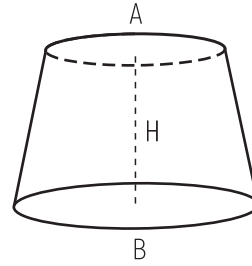

LG-L

A = 200
B = 300
H = 210

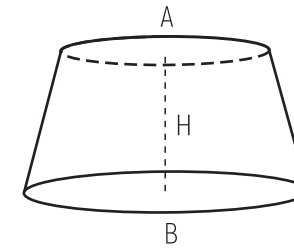

LG-C

A = 280
B = 320
H = 170

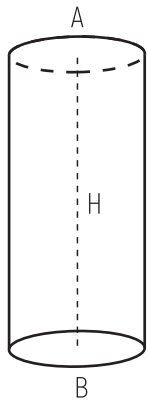

LG-T/180

A = 180
B = 180
H = 300

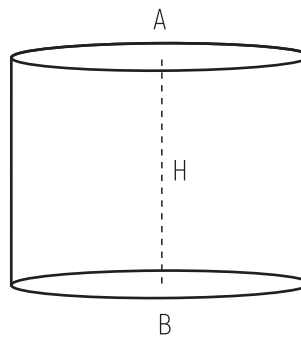

LG-T/250

A = 250
B = 250
H = 300

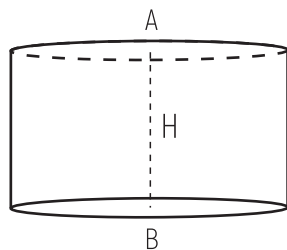

LG-W/180

A = 300
B = 300
H = 180

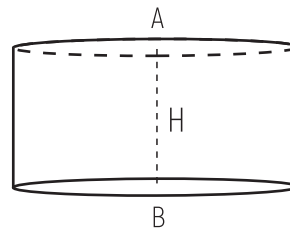

LG-W/130

A = 300
B = 300
H = 130

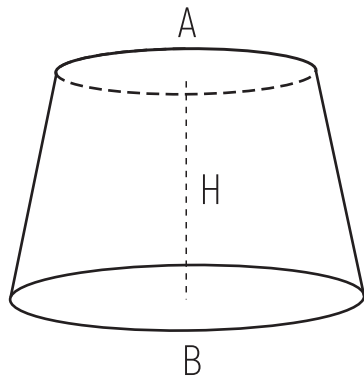

LS-L

A = 270
B = 530
H = 300

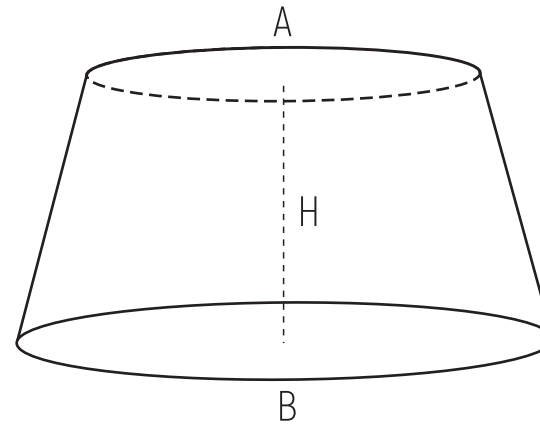

LS-M

A = 440
B = 550
H = 300

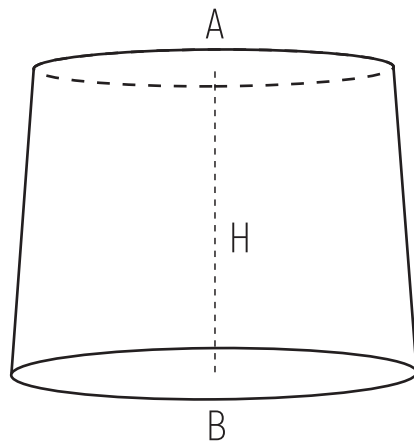

LS-N

A = 300
B = 450
H = 400

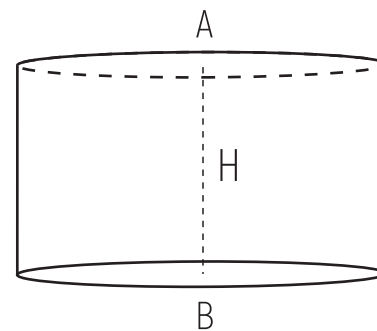

LS-T

A = 300
B = 300
H = 400

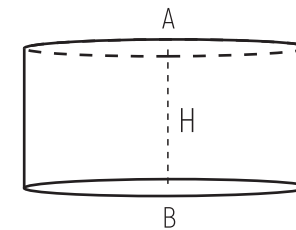

LS-W

A = 400
B = 400
H = 250

DOSTĘPNE KOLORY ABAŻURÓW

AVAILABLE COLOURS OF LAMPSHADES
ДОСТУПНЫЕ ЦВЕТА АБАЖУРОВ



2



17

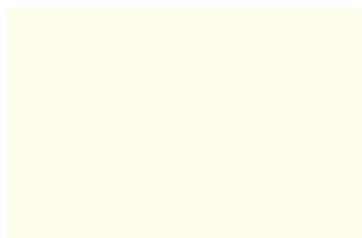

3

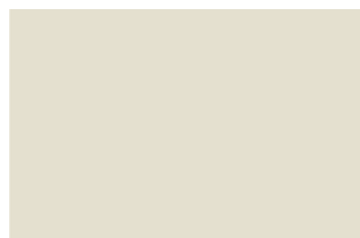

19

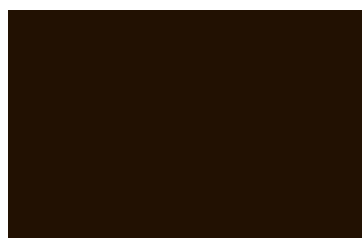

4

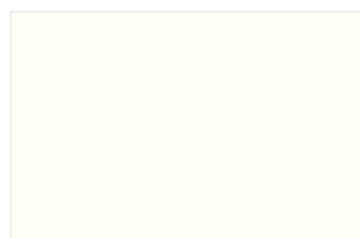

21



27



5



24



28



10 - Z



14 - Z

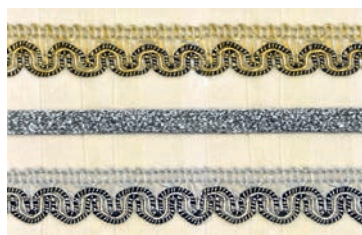

11 - Z
11 - SR - T
11 - S

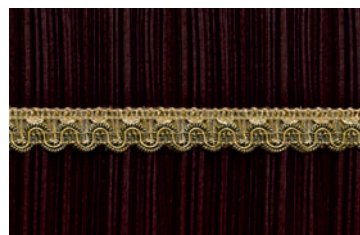

15 - Z



12 - Z
12 - SR - T
12 - S



20 - Z
20 - SR - T
20 - S

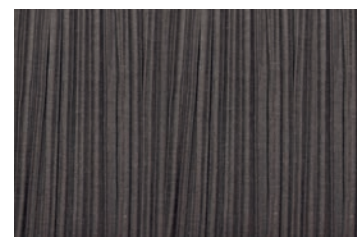

18



13 - Z

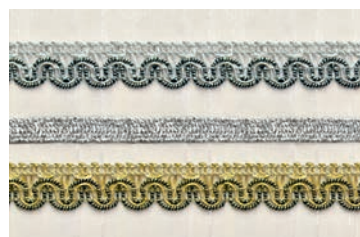

30 - Z
30 - SR - T
30 - S



22

AVAILABLE COLOURS OF LAMPSHADES
ДОСТУПНЫЕ ЦВЕТА АБАЖУРОВ



37 WELUR
VELVET
BAPXAM



41 WELUR
VELVET
BAPXAM

DOSTĘPNE KOLORY ABAŻURÓW

AVAILABLE COLOURS OF LAMPSHADES
ДОСТУПНЫЕ ЦВЕТА АБАЖУРОВ

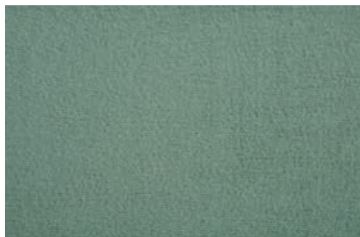

38 WELUR
VELVET
BAPXAM

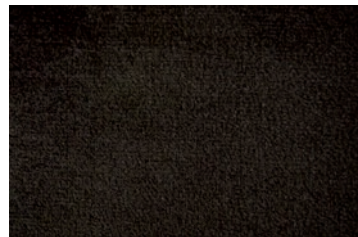

42 WELUR
VELVET
BAPXAM



44



39 WELUR
VELVET
BAPXAM



43 WELUR
VELVET
BAPXAM



45



40 WELUR
VELVET
BAPXAM



46



F.P.H. KUTEK MACIEJ KUTEK
ul. Wręczycka 188
42 - 200 Częstochowa
Polska

+ 48 34 362 91 40
+ 48 34 506 50 09

salon.firmowy@kutek.com.pl

2022

P R A C O W N I A L A M P

KUTEK.COM.PL



European Union
European Regional
Development Fund

