



# Ripple

by  
BIG - Bjarke Ingels Group

**Artemide<sup>®</sup>**

**ripple**

# Authors

## BIG - Bjarke Ingels Group

BIG is a Copenhagen, New York, London and Barcelona based group of architects, designers, urbanists, landscape professionals, interior and product designers, researchers and inventors. The office is currently involved in a large number of projects throughout Europe, North America, Asia and Middle East.

BIG's architecture emerges out of a careful analysis of how contemporary life constantly evolves and changes. Not least due to the influence from multicultural exchange, global economical flows and communication technologies, that all together require new ways of architectural and urban organization. They believe that in order to deal with today's challenges, architecture can profitably move into a field that has been largely unexplored. A pragmatic utopian architecture that steers clear of the petrifying pragmatism of boring boxes and the naïve utopian ideas of digital formalism. Like a form of programmatic alchemy, they create architecture by mixing conventional ingredients such as living, leisure, working, parking and shopping. By hitting the fertile overlap between pragmatic and utopia, they once again find the freedom to change the surface of our planet, to better fit contemporary life forms.



# Ripple

## BIG - Bjarke Ingels Group 2019

This suspension system shapes the qualities of space through molecular growth, combining light and sound absorption.

Comprised of circular structures in three different diameters, it works through layers of performance that can be modulated as required.

The structures can be simple electrical connection elements, unveil “pure” light or be enriched by a diffuser which, in addition to interacting with the light, offers sound absorption properties.

The basic element of the product is a circular ring whose profile is a synthesis of optics and mechanical engineering.

This freedom of configuration is then mirrored by the flexibility in management granted by interaction with Artemide App.



**Artemide  
App**



For further information on Ripple  
↪ visit [artemide.com](https://www.artemide.com)



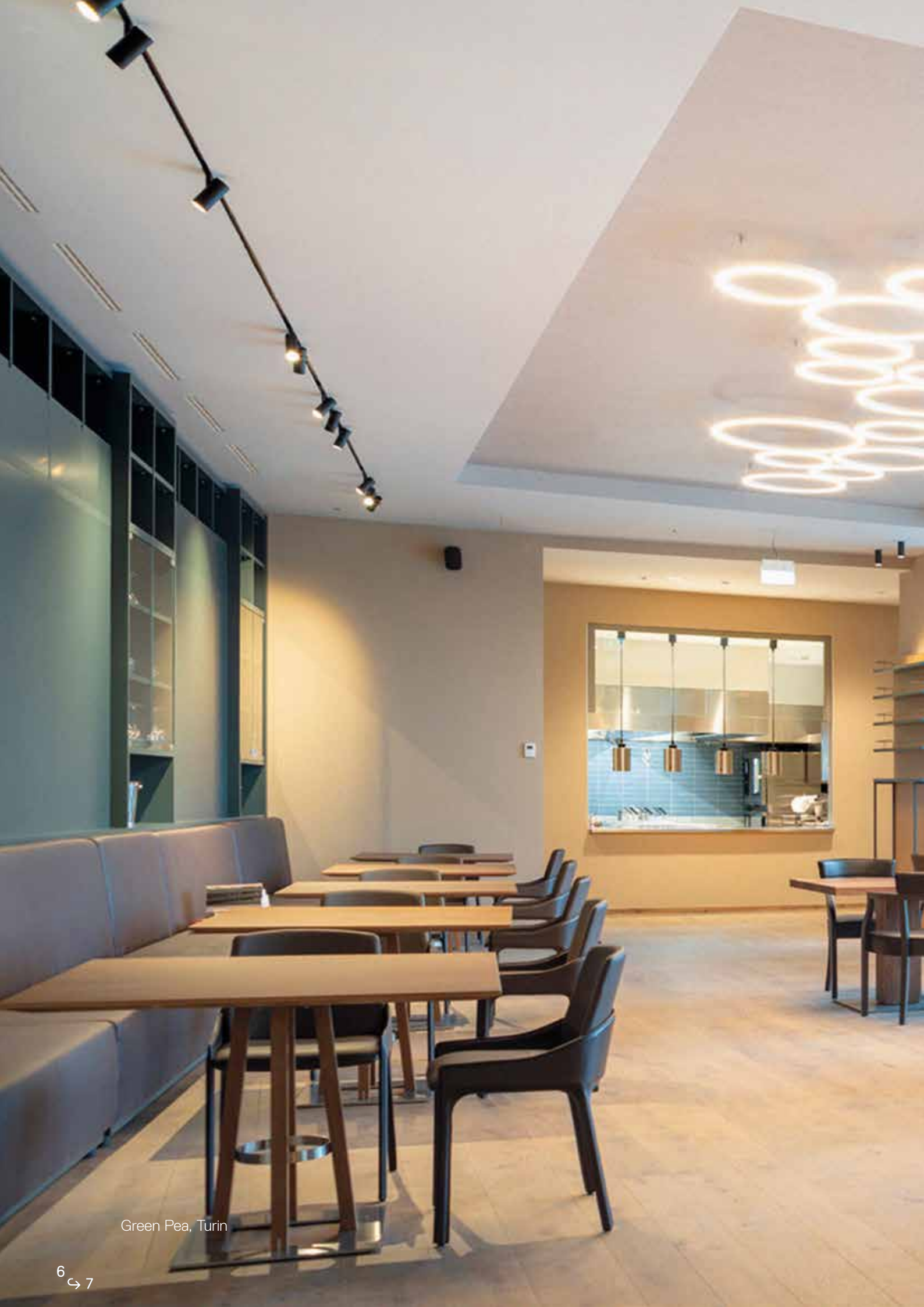

Green Pea, Turin







Ripple 500 — — — —  
50 W - 3089 lm  
3000K



Ripple 700 — — — —  
50 W - 3339 lm  
3000K



Ripple 900 — — — —  
50 W - 3378 lm  
3000K



Constant Current Design

Ripple Cluster — — — —  
89 W - 5806 lm  
3000K

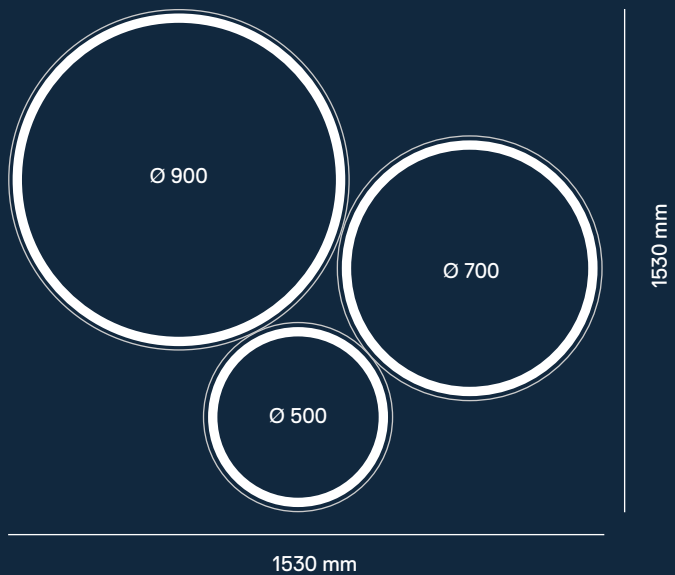

Constant Voltage Design







# Optical comfort

From the optical point of view, it is a LED system combined with a mixing chamber treated with a high diffusive reflection coefficient paint (> 90%) and an opal diffuser with a very low absorption coefficient.

The low absorption coefficient of the diffuser causes the portion of light that is retro-reflected towards the LEDs to be reprocessed by the mixing chamber and re-emitted towards the diffuser itself. In this way, an excellent uniformity of the diffuser is achieved, combined with a high optical efficiency.

The emission is lambertian. By acting appropriately on the power supply currents, it is possible to obtain a “comfort” light that adapts to all the spaces of life.







STANDARD SETTING - 50W - DIFFERENT LUMINANCES

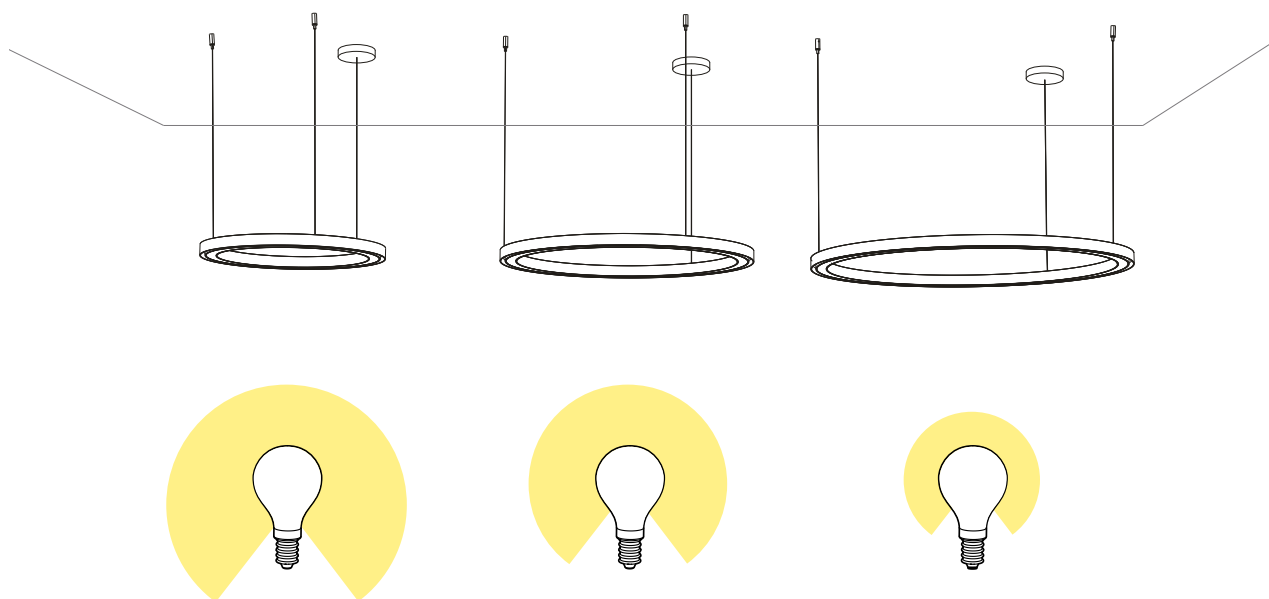

FREE SETTING - DIFFERENT CURRENTS - SAME LUMINANCES

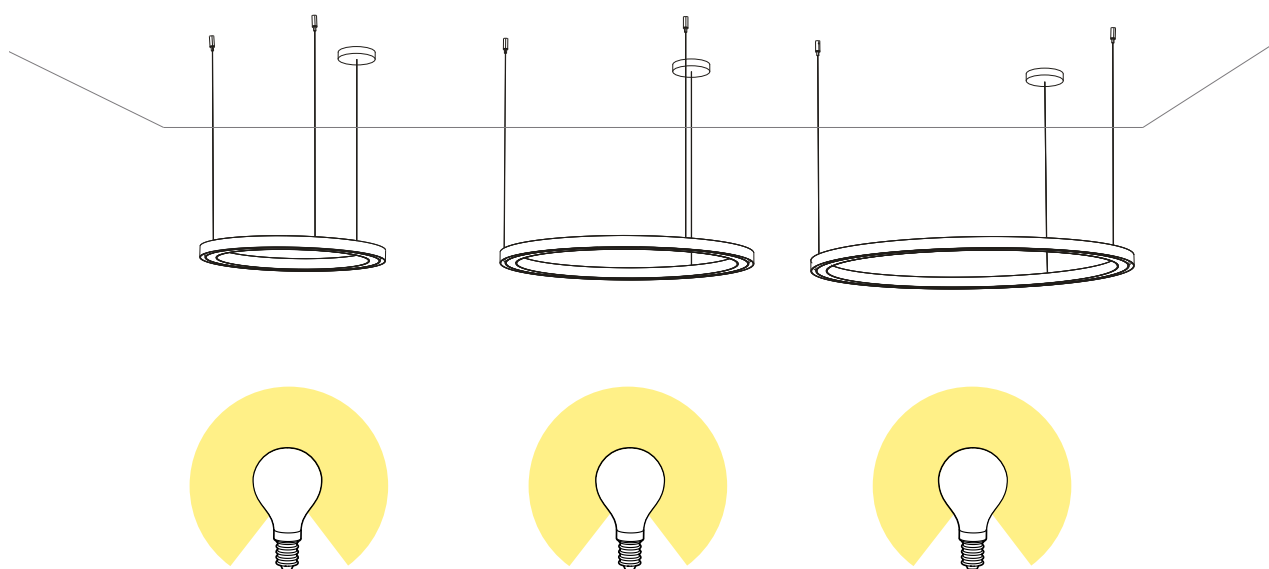

# Perceptive freedom

Designed to be used as a stand-alone also to form composited configurations in a fluid and dynamic way, Artemide gives the user the possibility to select the desired perceptive effect.

As a production standard, the three stand alone modules are preconfigured to have the same power (50 W) but through a simple current setting, which takes place during the installation phase, the user is free to choose the same luminance among different modules to standardize the appearance of several nearby appliances and ensure perceptual homogeneity even within an articulated layout.

# Mechanical and electrical bridge

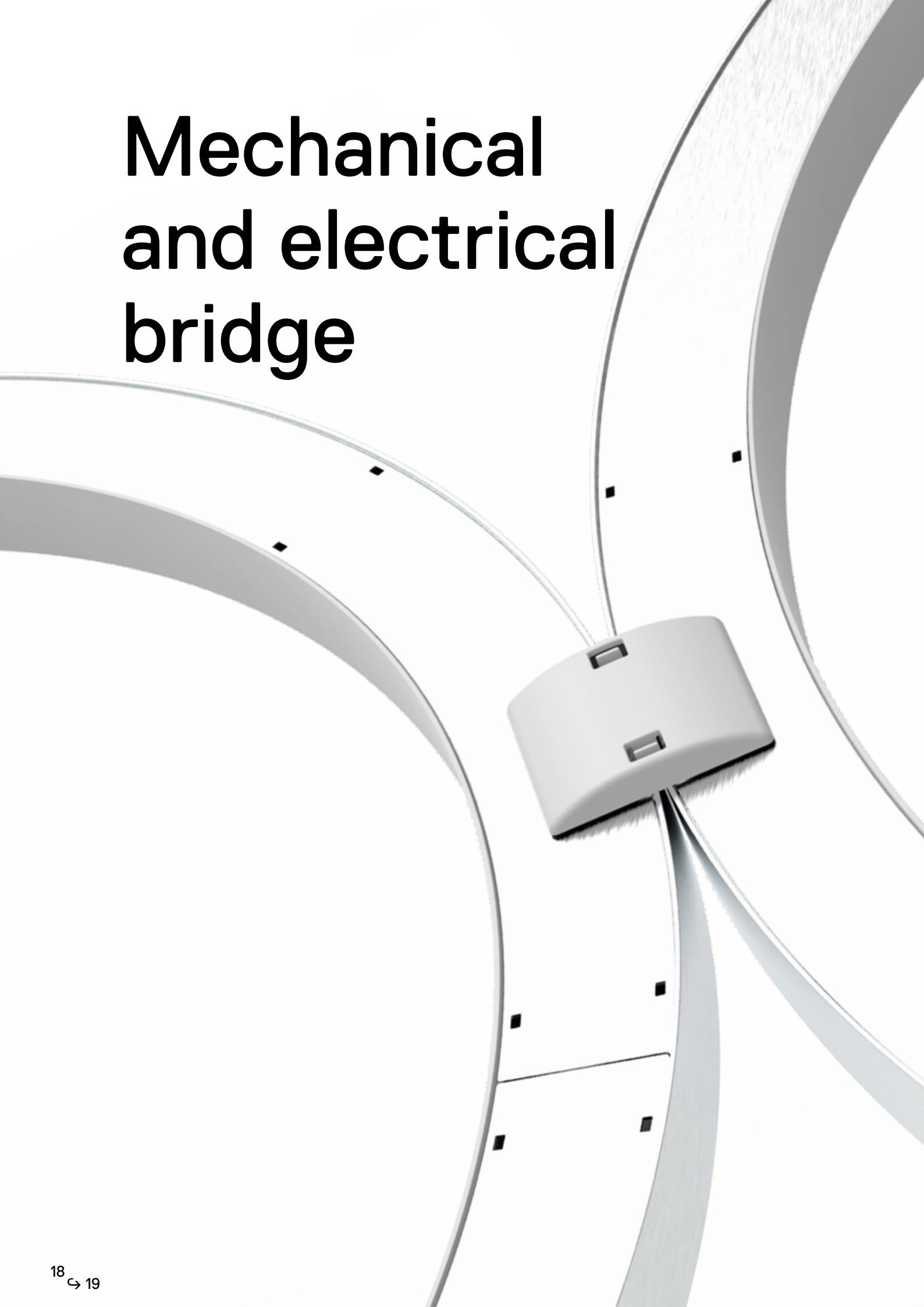



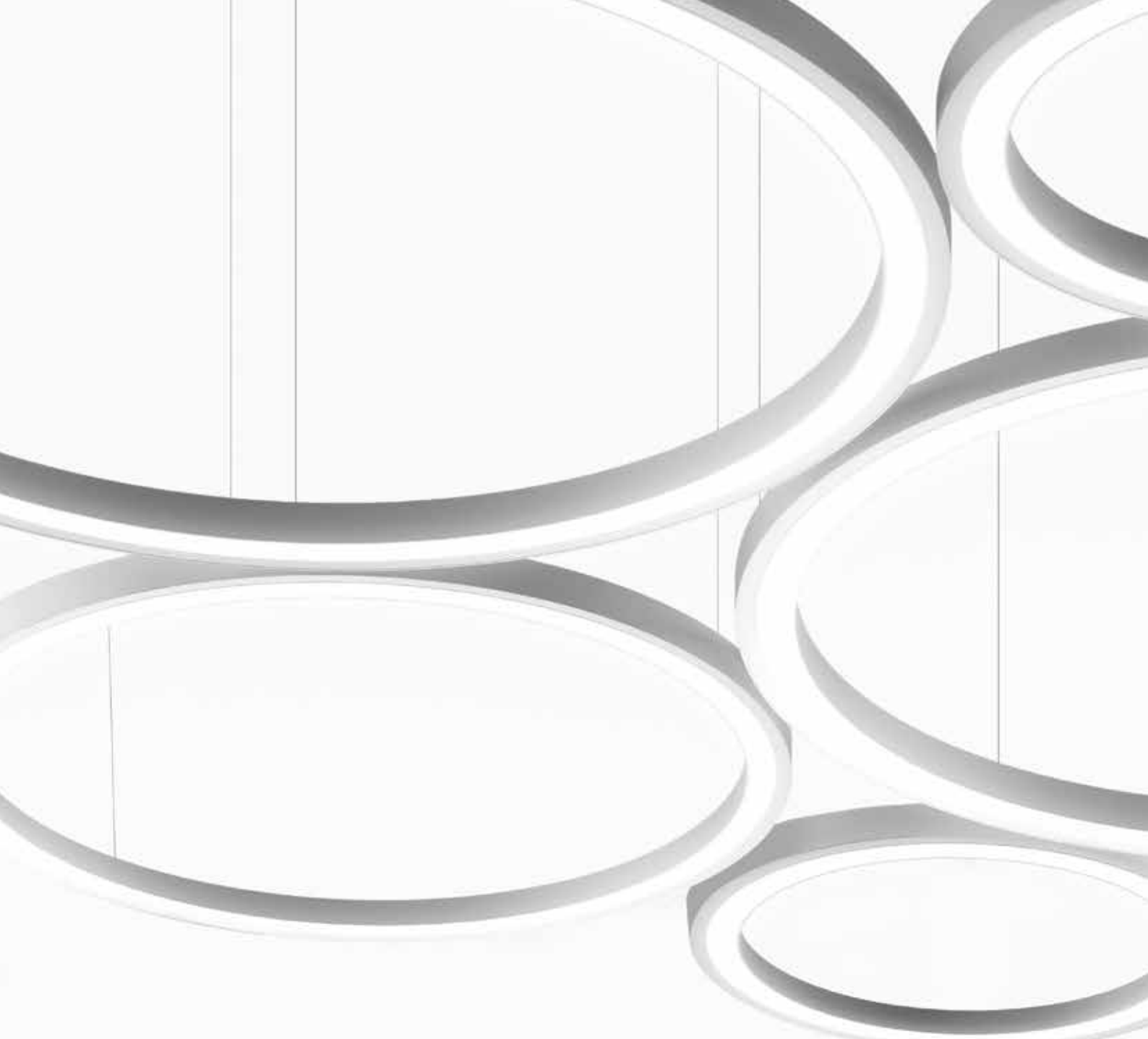

# Molecular growth



It is a suspension system that models the qualities of space according to a molecular growth.

Once again, Artemide's project with BIG is guided by a strong idea of interaction with spaces, an open, modular and scalable solution that combines technological innovation with compositional intelligence. Something apparently elementary but scenographic and full of potential.



Ripple cluster  
89W - 5806 lm



1530 mm

1530 mm

Ripple cluster X4  
127W - 7380 lm



1742 mm

1463 mm

Ripple cluster X5  
140W - 9210 lm



1902 mm

1580 mm

Ripple cluster X6  
148W - 9740 lm

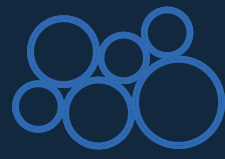

2088 mm

1394 mm

Ripple cluster A  
296W



4026 mm

1413 mm

Ripple cluster B  
517W

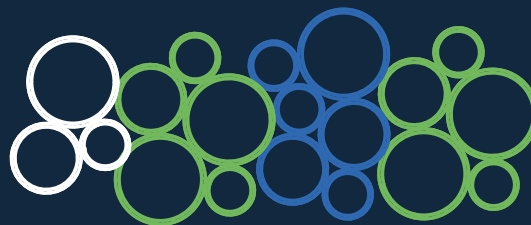

5220 mm

2140 mm

Ripple cluster C  
432W

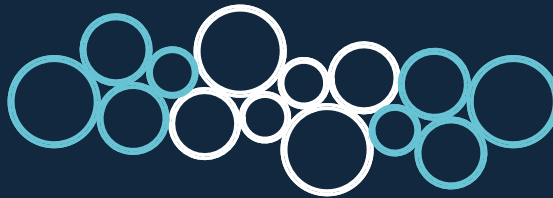

5448 mm

1877 mm

Ripple cluster D  
445W



5153 mm

2078 mm

Ripple cluster E  
377W



2898 mm

3154 mm

Ripple can grow from the light measured parameters and their relationship with space.

Molecular configurations are treated as be-spoke solution starting from the configurations shown.

In the molecular configurations the rings are Constant Voltage Design. With a total power of 240 W-48V, one power kit can support max 210 W-48V, overcoming this total power another feeding kit must be added.





## Texfel®

- Sound absorption
- Thermal and acoustic insulation properties
- 100 % recyclable and up to 90% of the content of recycled polyester 100%
- VOC free
- Easy to manufacture, handle and clean
- Flame-retardant colour felts
- with a velour finish
- High abrasion resistance
- Colour fastness to light
- Non-woven fabric, warm and pleasant to the touch
- RoHS and REACH Compliance
- STANDARD 100 by OEKO-TEX®
- Contribution to various credits to LEED v.4 and BREEAM certification

# Acoustic Quality

The bare structural ring of Ripple allows the distribution of sound-absorbing modules in space and the fullest possible exploitation of their potential, leaving the sound-absorbing surfaces as exposed as possible.

Frequency[Hz]	T <sub>1</sub> [s]	T <sub>2</sub> [s]	A <sub>obj</sub> [m <sup>2</sup> ]
500	5.30	3.61	1.2
630	5.21	3.46	1.3
800	5.00	3.36	1.3
1000	4.67	3.17	1.4
1250	4.36	3.00	1.4
1600	3.78	2.65	1.5
2000	3.18	2.28	1.7

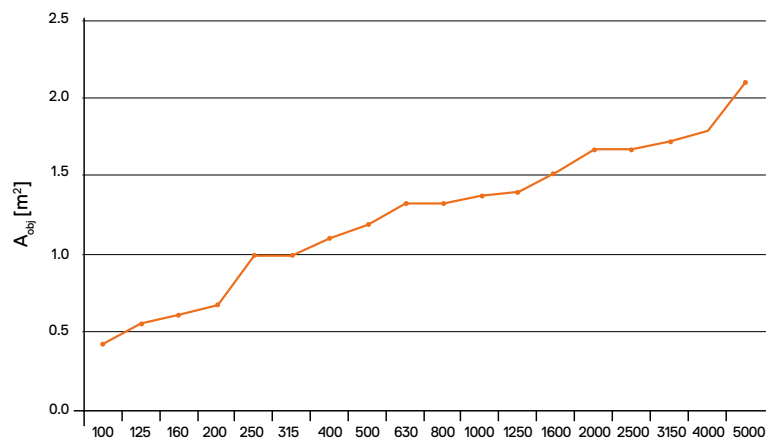

Acoustic comfort is the psychophysical condition of well-being in which we find ourselves when we are surrounded by sound, in relation to the activity we are performing. A place's acoustic quality is determined by reverberation time, space and the sound-absorbing, reflective and distribution properties of the surfaces that cover it.

A<sub>obj</sub> (m<sup>2</sup>) is the equivalent acoustic absorption value of an object at different sound frequencies necessary to calculate the reverberation time of a space.

Three different diffuser dimensions for infinite combinations.

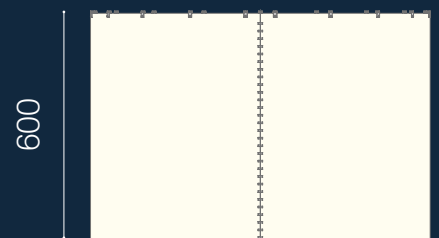
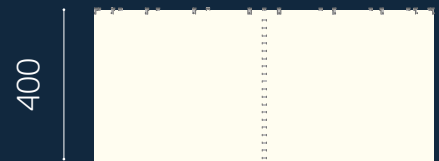
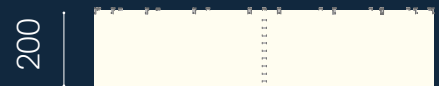
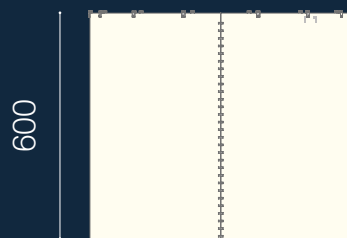
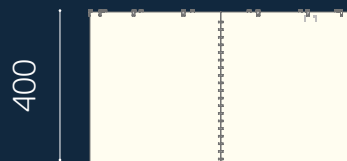
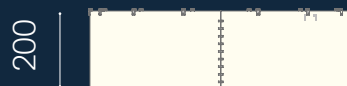
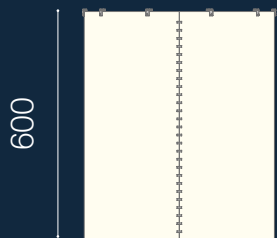
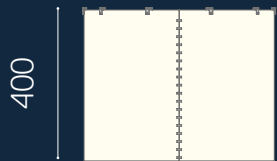









**01** Structure

**02** Light engine

**03** Diffuser with  
acoustic absorption

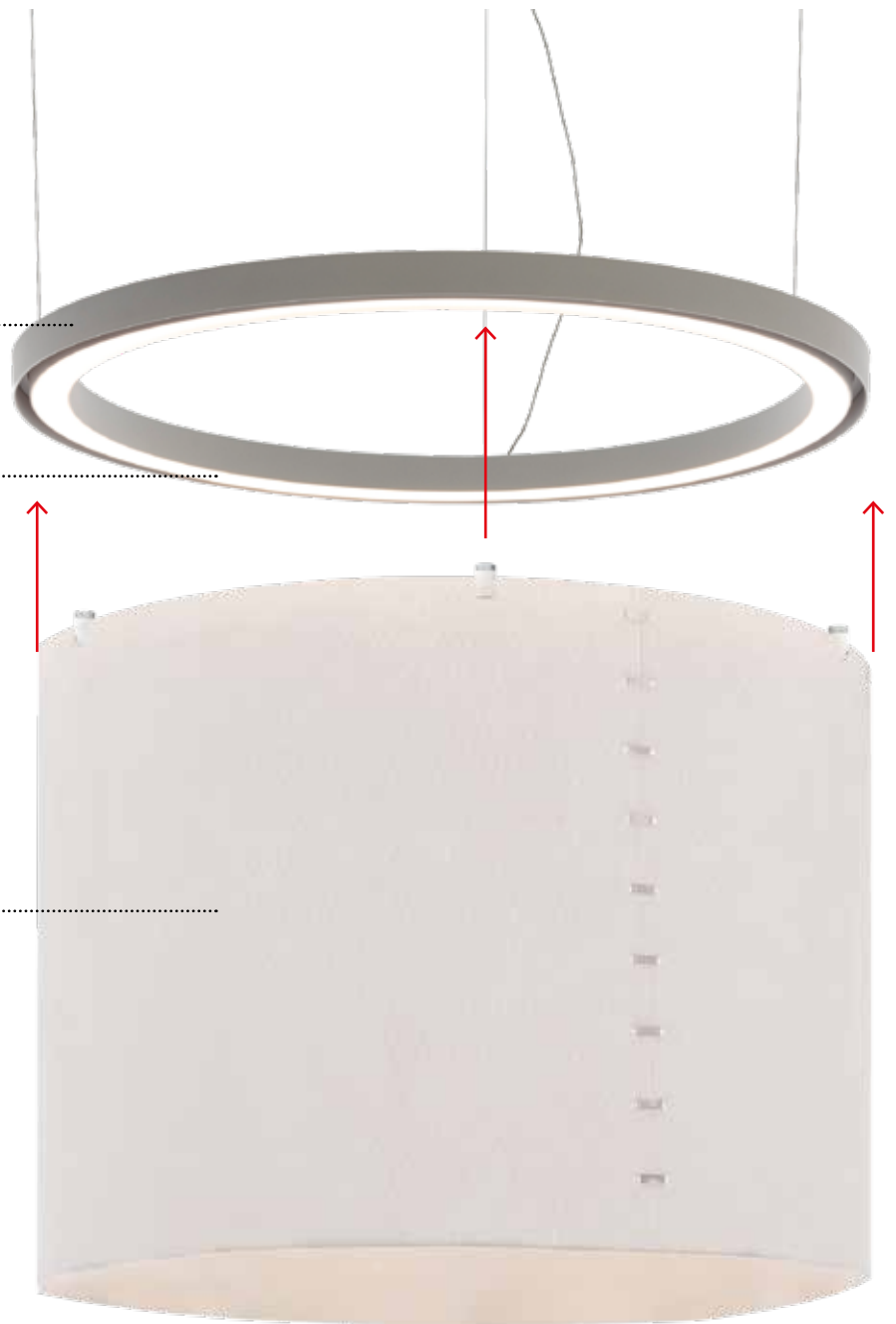

Magnets for fixing



Metal clips

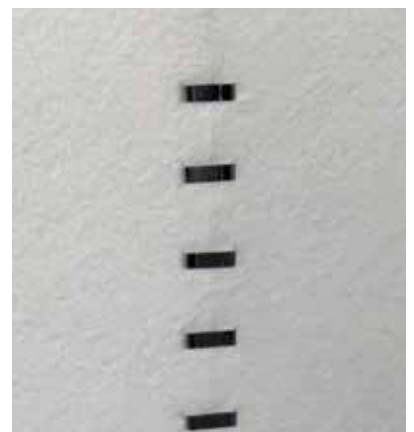





Giuntini Headquarters, Pisa



# Ripple

## Materials:

Aluminum, technopolymer

## Colours:

White

**Color Temperature:** 3000K

**CRI:** 90

## Ripple 500:

Dimensions: ø500 mm x 30 mm

Total Power: 50 W

Delivered Luminous Flux: 3089 lm

## Ripple 900:

Dimensions: ø900 mm x 30 mm

Total Power: 50 W

Delivered Luminous Flux: 3378 lm

## Ripple 700:

Dimensions: ø700 mm x 30 mm

Total Power: 50 W

Delivered Luminous Flux: 3339 lm

## Ripple Cluster:

Dimensions: 1350 mm x 1530 mm x 30 mm

Total Power: 89 W

Delivered Luminous Flux: 5806 lm

### Ripple 500

W	Flux	CCT
50 W	3089 lm	3000K

### PUSH

Code
2060010A

### APP / PUSH

Code
2060010APP

### Ripple 700

W	Flux	CCT
50 W	3339 lm	3000K

### PUSH

Code
2061010A

### APP / PUSH

Code
2061010APP

### Ripple 900

W	Flux	CCT
50 W	3378 lm	3000K

### PUSH

Code
2062010A

### APP / PUSH

Code
2062010APP

### Ripple Cluster

W	Flux	CCT
89 W	5806 lm	3000K

### PUSH

Code
2063010A

### APP / PUSH

Code
2063010APP

### Ripple 500

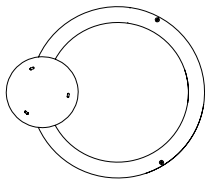
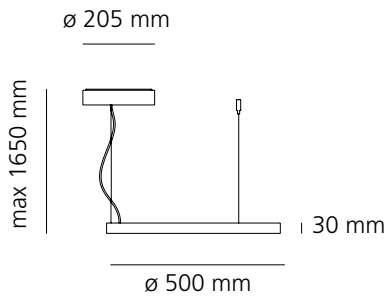

### Ripple 700

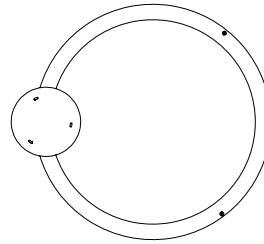
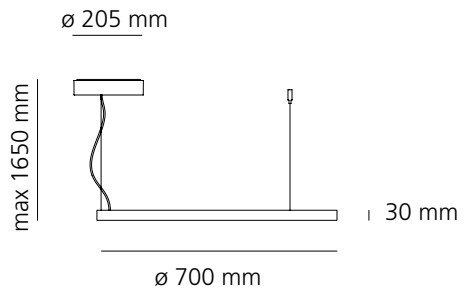

### Ripple 900

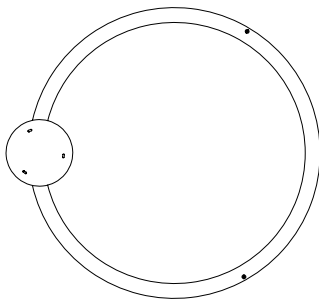
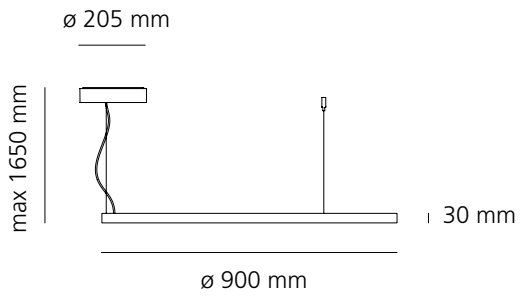

### Ripple Cluster

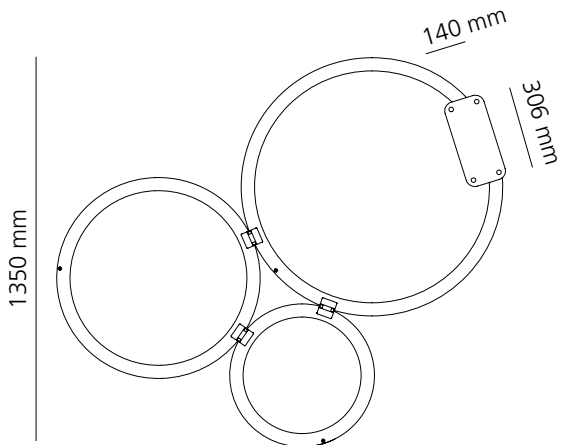
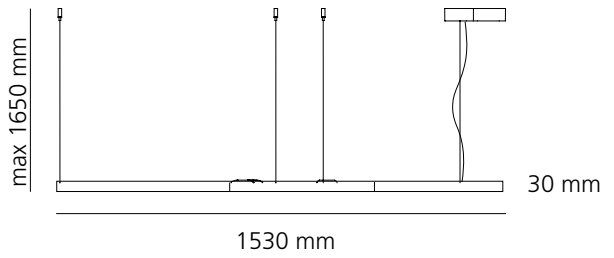

# Ripple diffusers

**Materials:**

Flame-retardant design felts with a velour finish and high abrasion resistance.

**Weight:**

500 gr/m<sup>2</sup>

**Thickness:**

3 mm

**Sound Absorption:**

UNE-EN ISO 354:aW=0,15 (H)

EN ISO 11654: Class E

**Colours:**

White

**Diffusers with acoustic absorption**

Diffuser Ø500 mm - h 200 mm  
Diffuser Ø500 mm - h 400 mm  
Diffuser Ø500 mm - h 600 mm

Diffuser Ø700 mm - h 200 mm  
Diffuser Ø700 mm - h 400 mm  
Diffuser Ø700 mm - h 600 mm

Diffuser Ø900 mm - h 200 mm  
Diffuser Ø900 mm - h 400 mm  
Diffuser Ø900 mm - h 600 mm

**Code**

**2072120A**  
**2072020A**  
**2072220A**

**2073120A**  
**2073020A**  
**2073220A**

**2074120A**  
**2074020A**  
**2074220A**

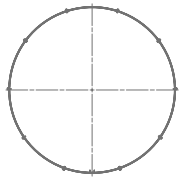

∅ 486 mm

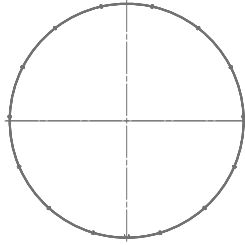

∅ 688 mm

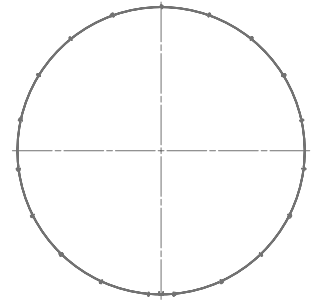

∅ 888 mm

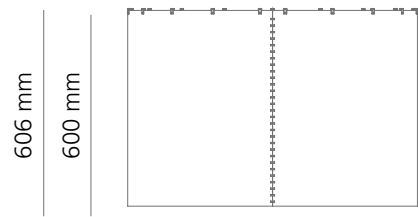
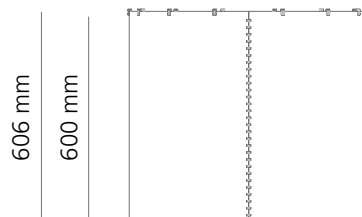
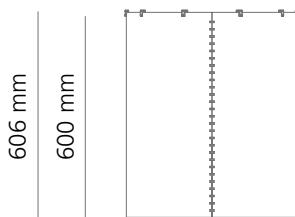
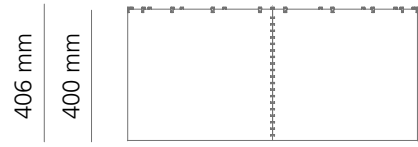
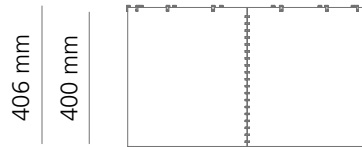
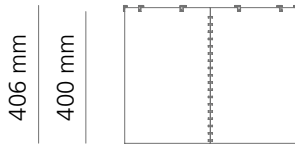
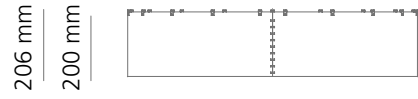
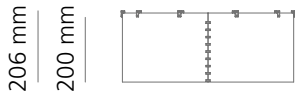

# Ripple is compatible with **Artemide App**

Artemide App is a user-friendly and intuitive interface used to control individual products, groups of appliances and lighting scenarios. It is a tool that can be associated with several products from both the Design and the Architectural Catalogues.





Download Artemide App  
and find more information on  
[artemide.com](https://www.artemide.com)



## Headquarters

### Artemide S.p.A.

Via Bergamo, 18  
20006 Pregnana Milanese (MI), Italy  
Tel. +39 02 93518.1  
Tel. +39 02 93526.1  
Numero verde 800 834 093  
(from Italy only)  
info@artemide.com  
artemide.com

### Artemide S.p.A.

si riserva la facoltà di modificare, in qualunque momento e senza preavviso, le caratteristiche tecniche degli elementi illustrati nel presente catalogo.

### Artemide S.p.A.

reserves the right to change, at any time and without prior warning, the technical specifications of any product illustrated in this catalogue.

### Artemide S.p.A.

se réserve le droit de modifier, à n'importe quel moment et sans préavis, les caractéristiques techniques des éléments illustrés dans ce catalogue.

### Artemide S.p.A.

behält sich das Recht vor jederzeit und ohne Ankündigung die technischen Daten der im Katalog abgebildeten Produkte zu ändern.

### Artemide S.p.A.

se reserva la facultad de modificar, en cualquier y sin aviso previo, las características técnicas de los elementos ilustrados en el presente catálogo.

2022 updated version.

**Artemide®**